



# UR75

## Quick Start Guide



## Welcome

Thank you for choosing Milesight UR75 industrial cellular router.

This guide describes how to install the UR75 and how to log in the Web GUI to configure the device. Once you complete the installation, refer to the Milesight UR75 User Guide for instructions on how to perform configurations on the device.

## Related Documents

This Start Guide only explains the installation of Milesight UR75 router. For more functionality and advanced settings, please refer to the relevant documents as below.

Document	Description
UR75 Datasheet	Datasheet for UR75 industrial cellular router.
UR75 User Guide	Users could refer to the guide for instruction on how to log in the web GUI, and how to configure all the settings.

The related documents are available on Milesight website: <https://www.milesight-iot.com/>

## Declaration of Conformity

UR75 are in conformity with the essential requirements and other relevant provisions of the CE, FCC, and RoHS.



© 2011-2021 Xiamen Milesight IoT Co., Ltd.

### All rights reserved.

All information in this guide is protected by copyright law. Whereby, no organization or individual shall copy or reproduce the whole or part of this user guide by any means without written authorization from Xiamen Milesight IoT Co., Ltd.

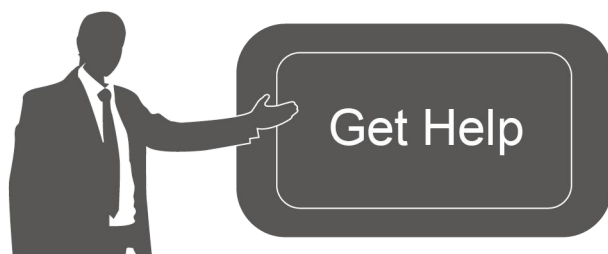

For assistance, please contact  
Milesight technical support:  
Email: [iot.support@milesight.com](mailto:iot.support@milesight.com)  
Tel: 86-592-5085280  
Fax: 86-592-5023065

## Revision History

Date	Doc Version	Description
Aug. 4, 2020	V 1.0	Initial version
Nov. 20, 2020	V 2.0	Layout replace

# 1. Packing List

Before you begin to install the UR75 router, please check the package contents to verify that you have received the items below.

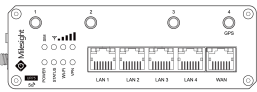

1 × UR75

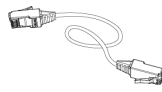

1 × Ethernet Cable

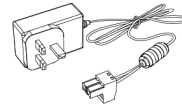

1 × Power Adapter



1 × 8-Pin Pluggable Terminal

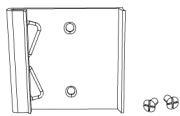

1 × DIN Rail Kit

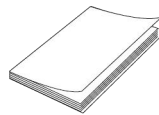

1 × Quick Start Guide



1 × Warranty Card

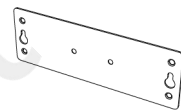

1 × Wall Mounting Bracket (Optional)

## UR75-5G Antennas:



4 × Stubby Cellular Antennas



2 × Stubby Wi-Fi Antennas

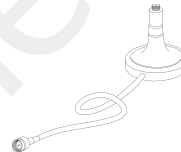

Antenna Magnetic Mount (Optional)

## UR75-4G Antennas:



2 × Magnetic Mount Cellular Antennas



2 × Stubby Wi-Fi Antennas



1 × GPS Antenna (GPS Version Only)



2 × Stubby Cellular Antennas (Optional)



**If any of the above items is missing or damaged, please contact your sales representative.**

## 2. Hardware Introduction

### 2.1 Overview

#### A. Front Panel of UR75-5G

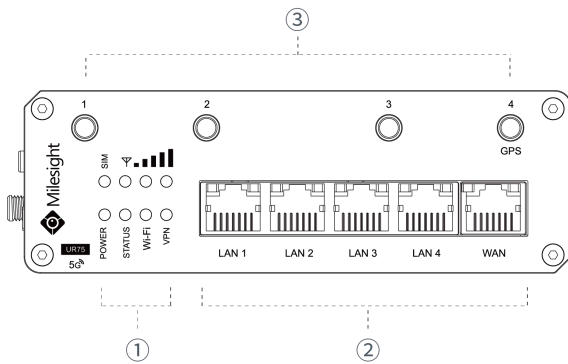

- ① LED Indicator Area  
 POWER: Power Indicator  
 SYSTEM: Status Indicator  
 Wi-Fi: Wi-Fi Indicator  
 VPN: VPN Indicator  
 SIM : SIM Status Indicator  
 ̳: Signal Strength Indicator
- ② Ethernet Ports & Indicators
- ③ Cellular Antenna Connectors  
 (Connector 4 is for both GPS and cellular)

#### B. Front Panel of UR75-4G

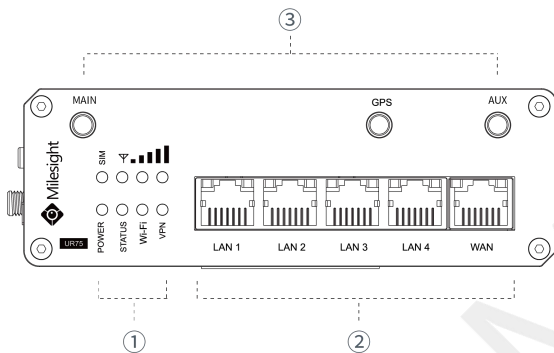

- ① LED Indicator Area  
 POWER: Power Indicator  
 SYSTEM: Status Indicator  
 Wi-Fi: Wi-Fi Indicator  
 VPN: VPN Indicator  
 SIM : SIM Status Indicator  
 ̳: Signal Strength Indicator
- ② Ethernet Ports & Indicators
- ③ Antenna Connectors  
 MAIN: Main Cellular Antenna Connector  
 AUX: Auxiliary Cellular Antenna Connector  
 GPS: GPS Antenna Connector

#### C. Left Side Panel

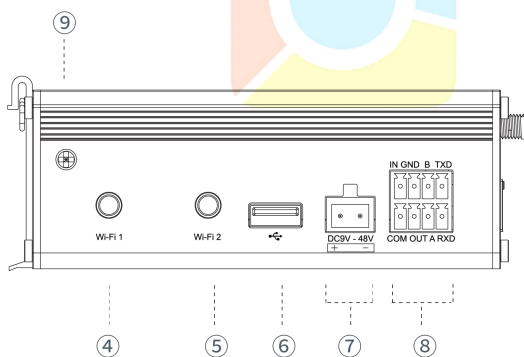

- ④ Wi-Fi Antenna Connector 1
- ⑤ Wi-Fi Antenna Connector 2
- ⑥ USB Port (Reserved)
- ⑦ Power Connector
- ⑧ Serial Port & I/O Ports
- ⑨ Grounding Stud

D. Right Side Panel

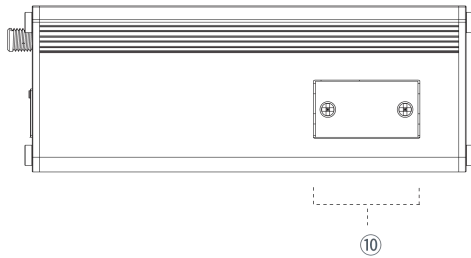

⑩ SIM and Reset Button Holder

2.2 Dimensions (mm)

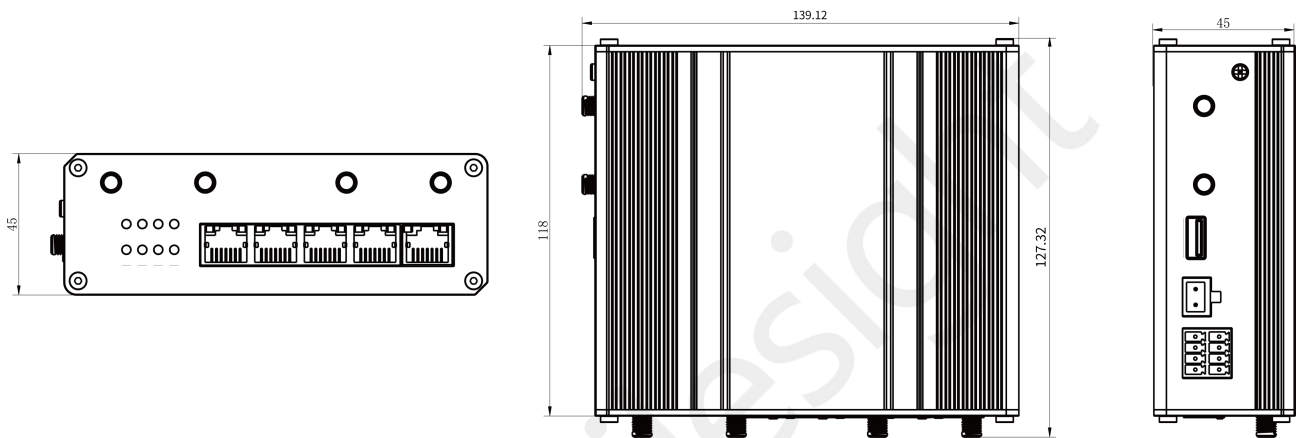

2.3 Connectors

Serial Port&I/O Ports

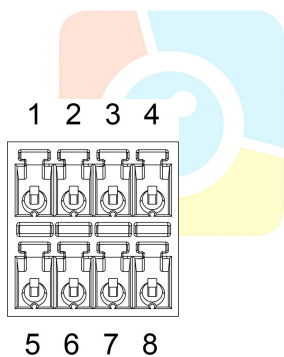

PIN	RS232	RS485	DI	DO	Description
1	---	---	IN	---	Digital Input
2	GND	---	GND	---	Ground
3	---	B	---	---	Data -
4	TXD	---	---	---	Transmit Data
5	---	---	---	COM	Common Ground
6	---	---	---	OUT	Digital Output
7	---	A	---	---	Data +
8	RXD	---	---	---	Receive Data

**Note:** For -RS485 model, RXD--->A, TXD--->B.

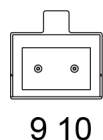

### Power Connector

PIN	Description	Wire Color
9	Positive	Red
10	Negative	Black

## 2.4 LED Indicators

LED	Indication	Status	Description
POWER	Power Status	Off	The power is switched off
		On	The power is switched on
SYSTEM	System Status	Green Light	Static: Start-up Blinking slowly: the system is running properly
		Red Light	The system goes wrong
VPN	VPN Status	Off	VPN is disconnected
		Green Light	VPN is connected
Wi-Fi	Wi-Fi Status	Off	Wi-Fi is disabled
		Green Light	Static: Wi-Fi is enabled Blinking slowly: sending or receiving data via Wi-Fi
SIM	SIM Card Status	Off	SIM1 or SIM2 is registering or fails to register (or there are no SIM cards inserted)
		Green Light	Blinking slowly: SIM1 (as primary SIM) has been registered and is ready for dial-up
			Blinking rapidly: SIM1(as primary SIM) has been registered and is dialing up now
			Static: SIM1 (as primary SIM) has been registered and dialed up successfully
		Orange Light	Blinking slowly: SIM2 (as primary SIM) has been registered and is ready for dial-up
			Blinking rapidly: SIM2 (as primary SIM) has been registered and is dialing up now
Static: SIM2 (as primary SIM) has been registered and dialed up successfully			
Signal Strength	Signal 1/2/3	Off	No signal
		Green Light	Static/Off/Off: weak signals with 1-10 ASU (please check if the antenna is installed correctly, or move the antenna to a suitable location to get better signal)
			Static/Static/Off: normal signals with 11-20 ASU (average signal strength)
			Static/Static/Static: strong signals with 21-31 ASU (signal is good)

## 2.5 Reset Button

Reset button is under the SIM slots.

Function	Description	
	SYSTEM LED	Action
Reset	Blinking	Press and hold the reset button for more than 5 seconds.
	Static Green → Rapidly Blinking	Release the button and wait.
	Off → Blinking	The router is now reset to factory defaults.

## 2.6 Ethernet Port Indicator

Indicator	Status	Description
Link Indicator (Orange)	On	Connected
	Blinking	Transmitting data
	Off	Disconnected



### 3. Hardware Installation

#### Environmental Requirements

- Power Input: 9-48 VDC (48 VDC is needed for PoE output)
- Power Consumption:  $\leq 7.9\text{W}$  (In Non-PoE mode)
- Operating Temperature:  $-40^{\circ}\text{C}$  to  $70^{\circ}\text{C}$  ( $-40^{\circ}\text{F}$  -  $158^{\circ}\text{F}$ )
- Relative Humidity: 0% to 95% (non-condensing) at  $25^{\circ}\text{C}/77^{\circ}\text{F}$

#### 3.1 SIM Card/Micro SD Card Installation

**!** UR75 do not support hot-plug. Please cut off the power before insert or take off cards.

- A. Unscrew the holder of the SIM card.

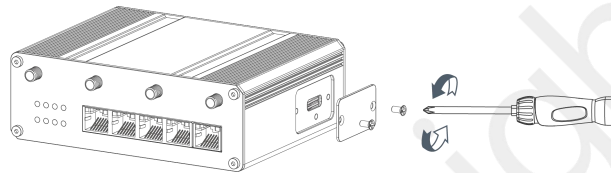

- B. Insert the SIM card(s) into the device following the triangle location of SIM card(s).  
C. Put SIM card into the slot and screw it up.

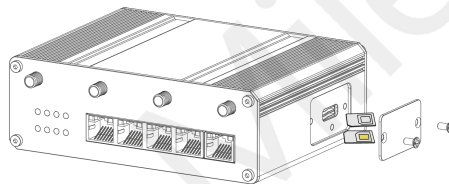

#### 3.2 Antenna Installation

Rotate the antenna into the antenna connector accordingly.

The external antenna should be installed vertically always on a site with a good signal.

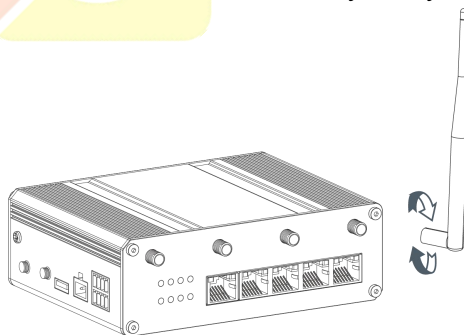

#### 3.4 Router Installation

The router can be placed on a desktop or mounted to a wall or a DIN rail.



### 3.4.1 Wall Mounting (Measured in mm)

Use 2 pcs of M3 × 6 flat head Phillips screws to fix the wall mounting kit to the router, and then use 2 pcs of M3 drywall screws to mount the router associated with the wall mounting kit on the wall.

**!** Recommended torque for mounting is 1.0 N·m, and the maximum allowed is 1.2 N·m.

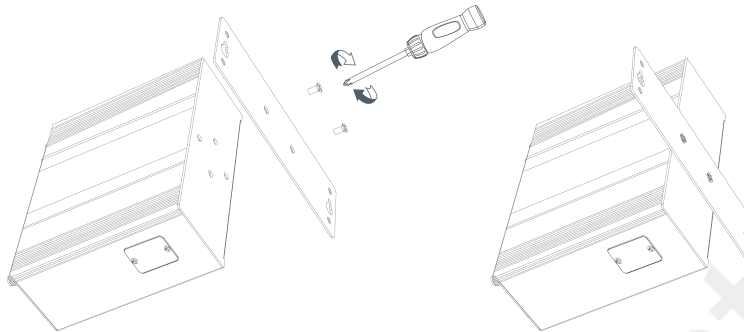

### 3.4.2 DIN Rail Mounting (Measured in mm)

Use 2 pcs of M3 × 6 flat head Phillips screws to fix the DIN rail to the router, and then hang the DIN rail on the mounting bracket. It is necessary to choose a standard bracket.

**!** Recommended torque for mounting is 1.0 N·m, and the maximum allowed is 1.2 N·m.

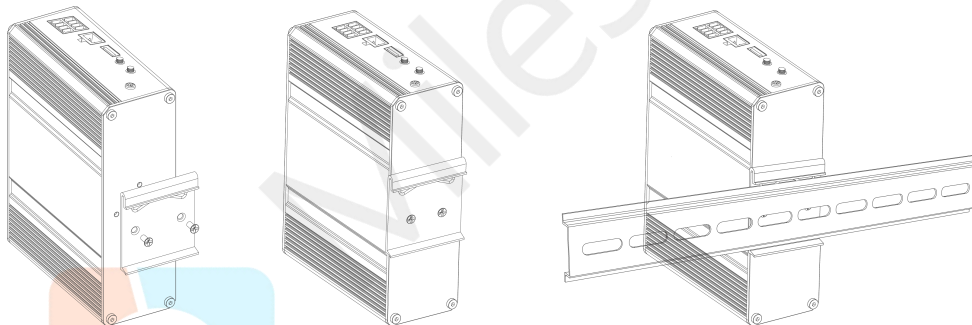

### 3.5 Protective Grounding Installation

- A. Remove the grounding nut.
- B. Connect the grounding ring of the cabinet's grounding wire onto the grounding stud and screw up the grounding nut.

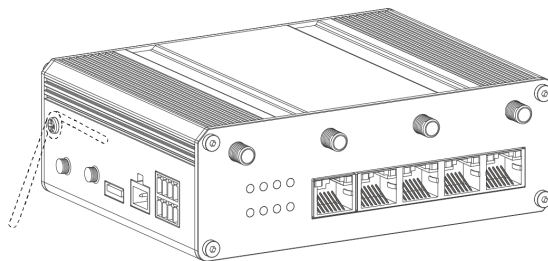

**!** The router must be grounded when deployed. According to operating environment, the ground wire should be connected with grounding stud of router.

## 4. Log in the Web GUI of Router

### 4.1 PC Configuration

Please connect PC to any port among LAN1-LAN4 of UR75 router. PC can obtain an IP address, or you can configure a static IP address manually. The following steps are based on Windows 10 operating system for your reference.

**(Note:** As remote access is disabled by default, you can't access to the router's Web GUI if you connect PC to WAN port of the router. But it will function properly if you enable it on Web GUI.)

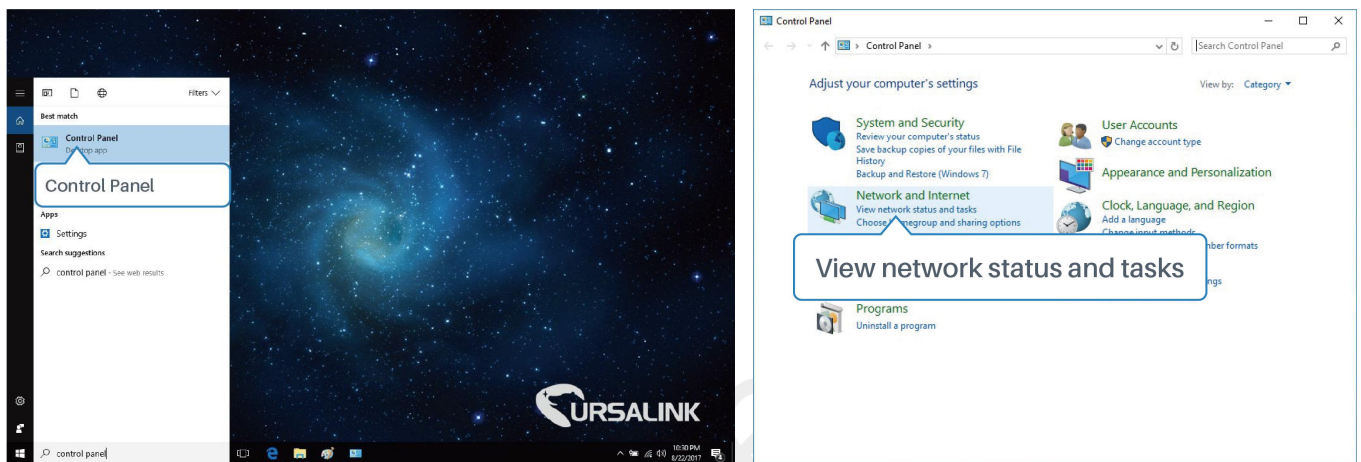

- ① Click "Search Box" to search "Control Panel" on the Windows 10 taskbar.
- ② Click "Control Panel" to open it, and then click "View network status and tasks".

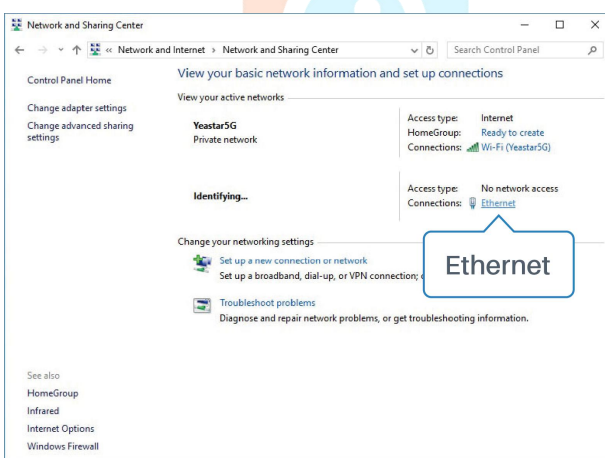

- ③ Click "Ethernet" (May have different names).

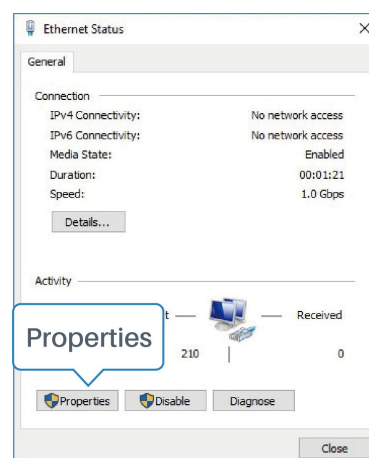

- ④ Click "Properties".

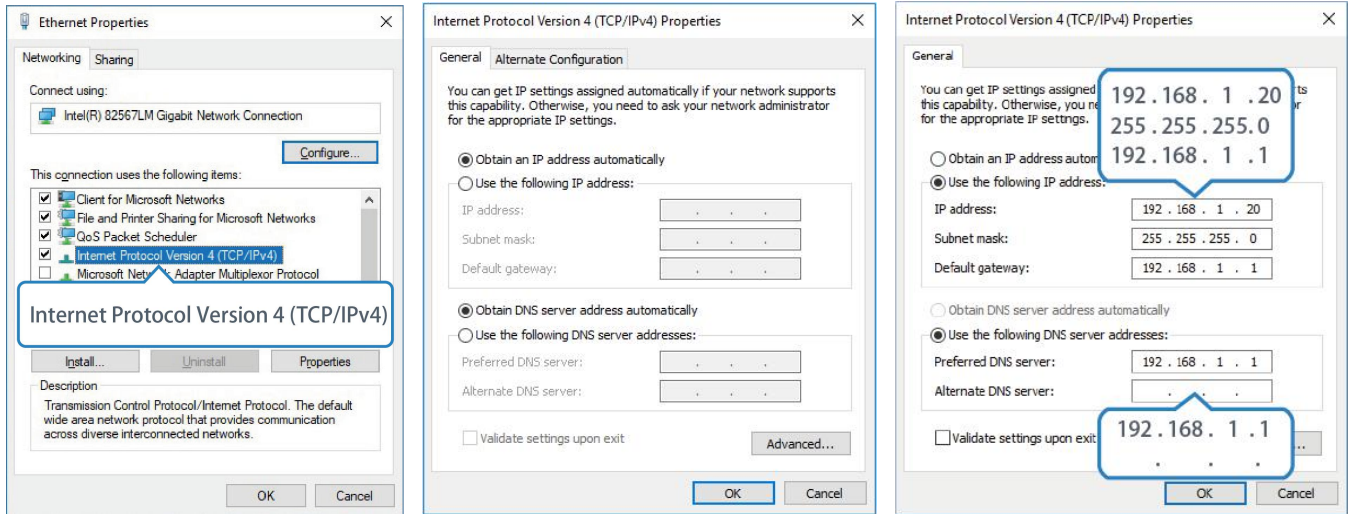

⑤ Double Click “Internet Protocol Version 4 (TCP/IPv4)” to configure IP address and DNS server.

⑥ Method 1: click “Obtain an IP address automatically”;

Method 2: click “Use the following IP address” to assign a static IP manually within the same subnet of the router.

(Note: Remember to click “OK” to finish configuration.)

## 4.2 Log in the Router

If this is the first time you configure the router, please use the default settings below:

IP Address: **192.168.1.1**

Username: **admin**

Password: **password**

- A. Start a Web browser on your PC (Chrome is recommended), type in the IP address, and press Enter on your keyboard.
- B. Enter the username and password, click “Login”.

English



 **If you enter the username or password incorrectly more than 5 times, the login page will be locked for 10 minutes.**

C. When you log in with the default username and password, you will be asked to modify the password. It's suggested that you change the password for the sake of security. Click "Cancel" button if you want to modify it later.

**Change Password** ✕

Old Password

New Password

Confirm New Password

Save
Cancel

D. After you log in the Web GUI, you can view system information and perform configuration on the router.

For your device security, please change the default password!

Status	Overview	Cellular	Network	WLAN	VPN	Routing	Host List	GPS	
Network	System Information		System Status						
System	Model	UR75-L01CE-W-G	Local Time	2020-07-29 16:17:18 Wednesday					
Industrial	Serial Number	6212A2074541	Uptime	4days, 22:01:17					
Maintenance	Firmware Version	76.1.0.11	CPU Load	1%					
APP	Hardware Version	V1.1	RAM (Available/Capacity)	233MB/512MB(45.51%)					
			Flash (Available/Capacity)	2879MB/4096MB(70.29%)					
	Cellular		WAN <span style="color: green;">● Link in use</span>						
	Status	Down	Status	Online					
	Current SIM	SIM1	IP	192.168.23.25					
	IP	0.0.0.0	MAC	24-e1:24:20:20:38					
	Connection Duration	0 days, 00:00:00	Connection Duration	0 days, 04:57:42					
	Data Usage Monthly	0.0 MiB	LAN						
	Status	Running	IP	192.168.20.1					
	Mode	AP	Connected Devices	0					
				Manual Refresh <span style="font-size: small;">▼</span>		<span style="background-color: #007bff; color: white; padding: 2px 10px;">Refresh</span>			

## 5. Network Configuration

This chapter explains how to connect UR75 to network via WAN connection or cellular.

### 5.1 Ethernet WAN Configuration

A. Go to “Network > Interface > WAN” to configure WAN parameters. Take static IP configuration as an example. DHCP client and PPPoE type are optional according to your requirements.

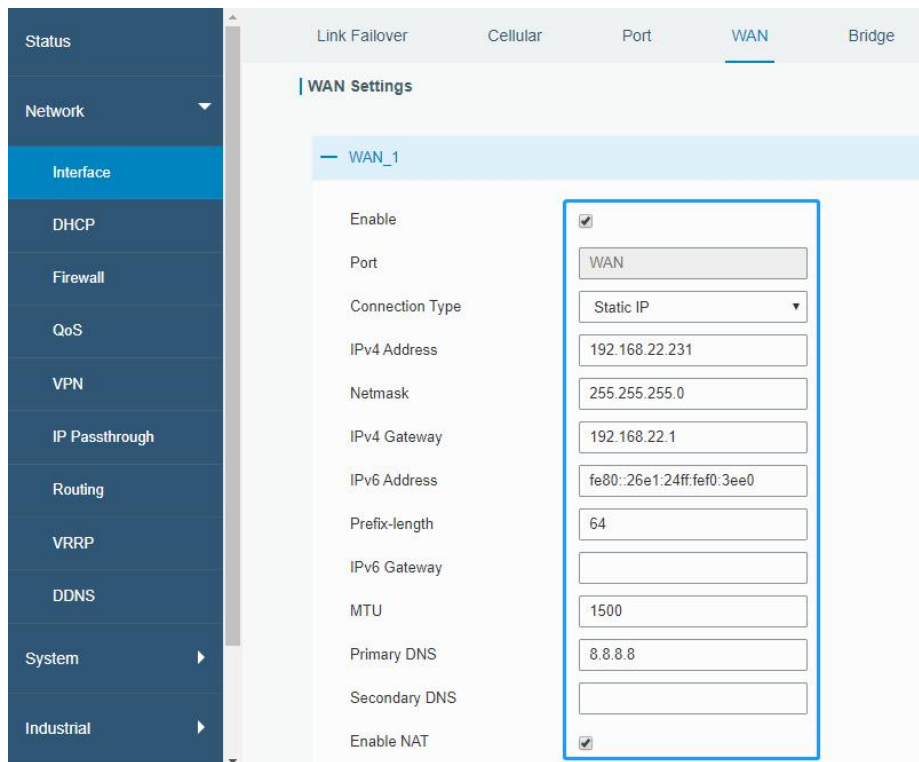

Click “Save & Apply” button to make the changes take effect.

B. Connect WAN port to another router or modem.

C. Log in UR75 web GUI via WAN port IP address and go to “Status > Network” to check if status is “up”.



D. Go to “Network > Interface > Link Failover” to rise the WAN priority to 1.

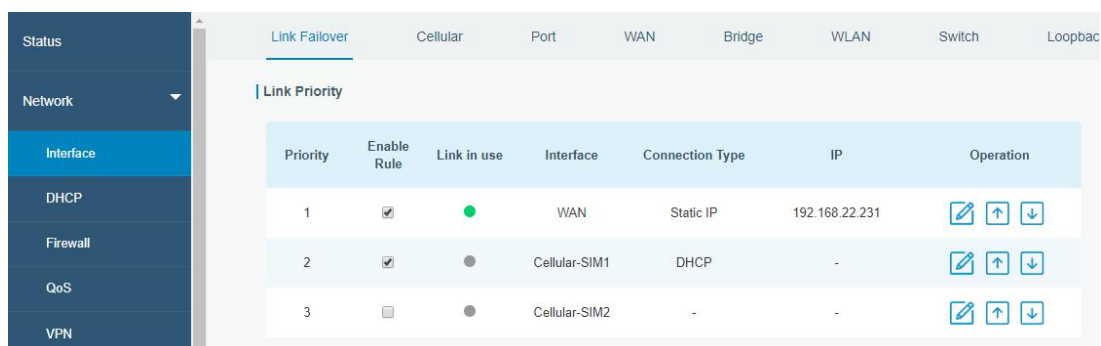

E. Open your preferred browser on PC, then type any available web address into address bar and see if it is able to visit Internet via UR75 router.

## 5.2 Cellular Connection Configuration

Take inserting SIM card into SIM1 slot as an example; please refer to the following detailed operations.

- Click “Network > Interface > Cellular > Cellular Setting” to configure the cellular info, like APN and network type.
- Click “Save” and “Apply” for configuration to take effect.

	SIM1	SIM2
APN	<input type="text"/>	<input type="text"/>
Username	<input type="text"/>	<input type="text"/>
Password	<input type="text"/>	<input type="text"/>
PIN Code	<input type="text"/>	<input type="text"/>
Access Number	<input type="text"/>	<input type="text"/>
Authentication Type	Auto	Auto
Network Type	Auto	Auto
PPP Preferred	<input type="checkbox"/>	<input type="checkbox"/>
SMS Center	+8613800592500	+8613800592500
Enable NAT	<input checked="" type="checkbox"/>	<input checked="" type="checkbox"/>
Roaming	<input checked="" type="checkbox"/>	<input checked="" type="checkbox"/>
Data Limit	0 MB	0 MB
Billing Day	Day 1 of The Month	Day 1 of The Month

If you select “Auto”, the router will obtain ISP information from SIM card to set APN, Username, and Password automatically. This option will only be taken effect when the SIM card is issued from a well-known ISP.

- Go to “Network > Interface > Link Failover” to enable SIM1 and rise link priority of SIM1.

Priority	Enable Rule	Link in use	Interface	Connection Type	IP	Operation
1	<input checked="" type="checkbox"/>	●	Cellular-SIM1	-	-	
2	<input checked="" type="checkbox"/>	●	Cellular-SIM2	DHCP	-	
3	<input checked="" type="checkbox"/>	●	WAN	Static IP	192.168.22.225	

- Click to configure ICMP ping detection information.

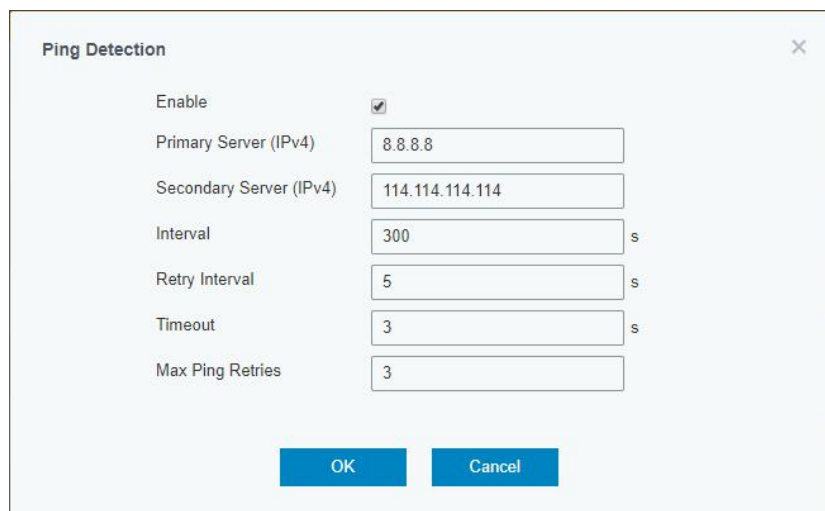

E. Click “Status > Cellular” to view the status of the cellular connection. If it shows “Connected”, it means SIM1 has dialed up successfully.

On the other hand, you can check the status of SIM indicator. If it keeps on green light statically, it means SIM1 has dialed up successfully.

Overview	Cellular	Network	VPN	Routing	Host List	GPS	
<b>Modem</b>		<b>Network</b>					
Status	Ready	Status	Connected				
Model	EC25	IP Address	10.2.25.74				
Current SIM	SIM1	Netmask	255.255.255.240				
Signal Level	29asu (-55dBm)	Gateway	10.2.25.73				
Register Status	Registered (Home network)	DNS	211.136.17.107				
IMEI	861585042050250	Connection Duration	0 days, 00:00:34				
IMSI	460045927703654	<b>Data Usage Monthly</b>					
ICCID	89860439101880723654	SIM-1	RX: 0.0 MiB TX: 0.0 MiB ALL: 0.0 MiB				
ISP	CHINA MOBILE	SIM-2	RX: 0.0 MiB TX: 0.0 MiB ALL: 0.0 MiB				
Network Type	FDD LTE						
PLMN ID	46000						
LAC	592f						
Cell ID	271f848						

F. Open your preferred browser on PC, then type any available web address into address bar and see if it is able to visit Internet via UR75 router.

**[END]**