

...the broadest narrowband money can buy



Operating manual



Narrowband modems – PROFI MR400, MR300, MR160

version 4.11
9/15/2015

Table of Contents

Introduction	5
1. Radio modem MR400 (MR300, MR160, MR160P)	6
2. Description of Radiomodem Functions	7
2.1. Radio part	7
2.2. Modem part	7
2.3. Supplying	7
2.4. Radio Modem Assembly	7
3. Connectors	9
3.1. Antenna	9
3.2. Serial Interface	9
3.3. Ethernet	11
3.4. Analog and Digital Inputs and Outputs	12
3.5. Supply Connector	14
3.6. Information LED	14
3.7. Service Connector	14
3.8. View of Radio Modem	15
4. Table of Technical Parameters	17
5. Dimensional Diagram and Labeling Modems	19
6. Modem installation	21
6.1. General description of installation	21
6.2. Antenna installation	21
6.3. Power supply	22
6.4. Technology connection	22
6.5. Mechanical mounting	22
7. Conditions for MR400 Operation	24
7.1. Important Warning	24
7.2. Conditions of Liability for Defects and Instructions for Safe Operation of Equipment.	24
7.3. RoHS and WEEE compliance	25
7.4. Product Conformity	26
7.5. Country of Origin	31
7.6. Limitations of Use	32
A. Revision History	33

List of Figures

1. Radio modem MR400 with Cannon connectors, MR300 with Cannon connectors and MR160 with screw clamps	5
3.1. RS232 DSUB9 female	9
3.2. Data cable RS485 connections	10
3.3. Labelling of serial interface terminals	11
3.4. RJ-45F	12
3.5. Wiring diagrams for analog and digital inputs and outputs	12
3.6. Description of analog and digital inputs and outputs	13
3.7. Examples of wiring analog inputs and outputs	13
3.8. Power connector & information LED	14
3.9. Service connector	14
3.10. Service cable connector connections	15
3.11. View of radio modem — description of connectors, model with DSUB (Canon) connectors and with terminals, numbering of slots	16
5.1. Mounting dimensions of the radiomodem MR400, MR300 and MR160	19

6.1. Example of a typical installation of a data network radio point	21
6.2. Example of the layout of equipment in a switchboard	23
7.1. Warning sticker IEC 60417-5041 (DB:2002-10)	25
7.2. Declaration of Conformity – MR400	28
7.3. Declaration of Conformity – MR300	29
7.4. Declaration of Conformity – MR160	30
7.5. Country of Origin declaration	31

List of Tables

3.1. Table of data connector RS232 connections	9
3.2. Table of data connector RS422 connections	10
3.3. Table for distinguishing LEDs for RxD and TxD by colour	10
3.4. Table of Ethernet to cable connector connections	12
3.5. Table of digital and analog input and output parameters	13
3.6. Table of service connector connections	14
3.7. Slot options	16
4.1. Table of technical parameters MR400, MR300, MR160	17
4.2. Standards complied	18
4.3. Railway Safety Appliance Standards Regulations	18

Introduction

This operator manual serves as the primary document for familiarising users with the parameters of the radio modem, its properties, modifications and with the parameters of connecting parts. In order to master all the functions of the radio modem and the MORSE system you should refer to other documents.

In next description is used the notation **modem** or **router** instead of **radiomodem**.



Fig. 1: Radio modem MR400 with Cannon connectors, MR300 with Cannon connectors and MR160 with screw clamps

1. Radio modem MR400 (MR300, MR160, MR160P)

MR 400, MR300 and MR160 are conceptually new radio modems designed for transmitting data in the VHF and UHF bands. The radio modem uses 4-state FSK modulation providing for a maximum signalling rate of 21.68 kbit/s.

The radio modem is of modular design with one to four standard RS232 ports (an RS422 or RS485 port can be used in place of two of them) available to the user. The configuration can be extended by an Ethernet interface and also by a module with analog and digital inputs/outputs. It is generally manufactured with two analog inputs and outputs and with two digital inputs and outputs.

The radio data transceiver module can be configured to a random frequency of the transmitter and receiver in the 3.2 MHz frequency range in a 25 kHz channel raster. The output and input working frequencies are mutually independent and are derived from the frequencies of four phase-locked systems programmed by the transceiver microprocessor. Channel settings are stored in the transceiver EEPROM memory and the FLASH memory module of the modem whose communication processor controls the operation of the transceiver microprocessor. The power of the radio modem transmitter is digitally set in sixteen steps from 0.1 to 5 W. In the case of high-performance radio modems of type P (see serial code) also in sixteen steps, but up to 25 W.

The design and construction of this device allows for long-term loading and for this reason it is primarily determined for continuously running applications.

Software control is compatible with the operation and configuration of the other radio modems of the MORSE system. A description of software control and configuration is available in publications describing MORSE Firmware.



Important

The radio modem is equipment which can only be operated in the Czech Republic on the basis of Permission to operate transmitting radio stations issued by the Department of Frequency Spectrum Management at the Czech Telecommunication Office.

2. Description of Radiomodem Functions

2.1. Radio part

The architecture of MR400 (MR300, MR160) radio modems resolves most of the requirements placed on a top quality user friendly radio modem with a very short switching time between receiving and transmitting. Frequency synthesis enables operation on any random channel from a given frequency band. The operation of the radio data transceiver module is controlled and diagnosed by the microcontroller. The receiving part of the radio modem works with double mixing. Concentrated selectivity is divided between both intermediate frequency levels. The first filter carries out basic channel pre-selection up until attenuation which ensures the linear function of the following second mixer and intermediate frequency amplifier. The second filter of concentrated selectivity has an attenuation characteristic necessary for channel selection in the used channel spacing of 25 kHz. Logic circuits, switching stations between modes of receiving and transmitting, have high noise immunity and switch respective blocks sequentially. This minimises most transient parasite states and optimises bandwidth during switching. Station block modes are logically tied and switching of the station to transmitting mode is tied to the frequency synthesiser lock, the internal temperature of the radio transceiver module and the value of the supply voltage.

2.2. Modem part

The control microcomputer has 4 MB of FLASH memory and 16 MB of RAM memory available. The battery, real time backup supply, detector of supply voltage failure and watch dog circuits belong amongst the other circuits of this block. If there is a supply voltage failure the fact is recorded into memory with the respective time data thanks to the charge stored in electrolytic capacitors. The user therefore has information available about the time and duration of possible faults caused by power failures. It is possible to connect equipment with signalling rates up to 115.2 kbit/s to the modem via the RS232 data interface. RS232 interface converters are protected against overvoltage with TRANSIL elements. A lithium battery is used for backing up in the modem part.



Note

Owing to the use of lithium batteries in the modem part it is not recommended to store them for a period of longer than 2 years.

2.3. Supplying

The radiomodem is supplied by the DC current 13.8 V. The consumption in the quiet state is from 350 to 500 mA according to module used, the consumption at transmitting is up to 2 A. (high-performance radio modems of type P – up to 5 A) The modem can be set in the SLEEP mode when the consumption drops down to 2.5 mA. The return in the active mode can be done by the signal inputting on the serial port or after a preset time.

2.4. Radio Modem Assembly

Radio modems MR400 (MR300, MR160) are special devices which require skilled assembly. All supplied equipment is assembled by RACOM at the user's site. For subsequent maintenance RACOM specially trains the user's skilled staff and as an additional aid provides them with Operating regulations for radio data networks and MORSE Firmware – Documentation.

High-performance radio modems of type P (see serial code) need to be installed in a manner which takes into consideration their high demand for heat dissipation, i.e. the rear side of the modem needs to lie tightly against the mounting plate, as it also serves as a heat sink.



Important

CAUTION! Danger of explosion upon replacing the incorrect type of battery. Follow the manufacturers instructions for handling used batteries.

3. Connectors

3.1. Antenna

The cable for connecting the antenna is fitted with an N type connector. Use a connector of the corresponding type and impedance as its mate. We recommend using an RG213 cable for aerial leads up to 25 m in length and a H1000 for longer leads.



Important

CAUTION. The radio modem cannot be connected to the power supply without the antenna connected (or corresponding artificial load). Otherwise this could lead to damage to the radio part of the modem.

3.2. Serial Interface

The router can be equipped with serial ports RS232 or RS422/485, the ports can be optical isolated. According to the configuration it is possible to use a terminal block or DSUB 9 (Canon) connectors for connecting data cables via the serial interface. See Chapter *Dimensional Diagram and Labeling*. Data rate on the serial interface can be from 200 bps to 230,400 bps.

3.2.1. RS232, RS422 and RS485 Connectors

a) Table of data connector RS232 connections

Tab. 3.1: Table of data connector RS232 connections

RS232 signal	Screw terminals	DSUB9F pin
CTS	1	8
RTS	2	7
RxD	3	2
TxD	4	3
GND	5	5
DTR		4
DSR		6
CD		1
RI		9



Fig. 3.1: RS232 DSUB9 female

b) Table of data connector RS422 connections

Tab. 3.2: Table of data connector RS422 connections

RS422 signal	Screw terminals	DSUB9F pin
TxD-	1	7
TxD+	2	3
RxD-	3	8
RxD+	4	2
GND	5	5

c) Connection diagram of data cable RS485

When you are connecting RS485, your “A” has to be connected to TxD+ and RxD+ simultaneously and “B” to TxD- and RxD- simultaneously.

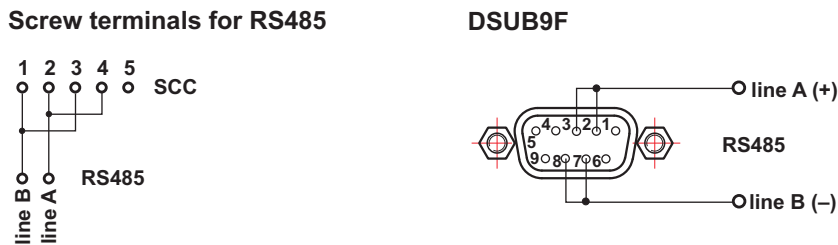

Fig. 3.2: Data cable RS485 connections

Note - For data connector RS485 connection see *Table of data connector RS422 connections*.

Important - For making data cables for connecting the user’s terminal equipment to the serial port we recommend using a shielded cable, particularly in an industrial environment, and connecting the shielding to GND (pin No. 5). When using a multi-core cable all free conductors should be connected to pin No. 5. In the case of a galvanically separate port for RS485 (RS422) only ground one side of the data cable. We recommend using only the necessary minimum length for data cables.

3.2.2. Distinguishing Data Modules by Colour

For RS232 RxD is the output from the router (approx. -6V when inactive) and TxD is the input to the router (according to the RS 232 standard). Hardware versions of the interface can be distinguished according to the colours of LED diodes next to the connector.

Tab. 3.3: Table for distinguishing LEDs for RxD and TxD by colour

Type of interface	Colour (RxD / TxD)
RS232	red / green
RS232 opt. separated	orange / green
RS422/485 opt. separated	orange / yellow

3.2.3. Labelling of SCC terminals

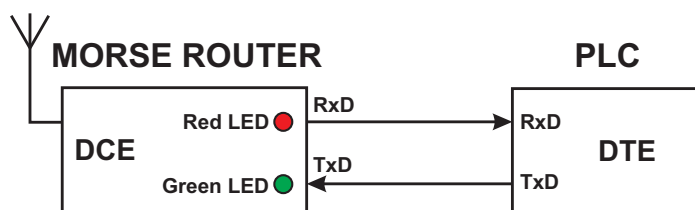

Fig. 3.3: Labelling of serial interface terminals

The SCC ports of the router are DCE type devices. Based on standards the receiver terminal RxD of the connected DTE device is connected to the transmitting terminal of the router's SCC port which is also labelled RxD. Similarly the red LED indicating transmission from SCC is labelled RxD.

3.3. Ethernet

- Connector RJ-45 for Ethernet 10BaseT and 100BaseT corresponds to the EIA TIA T568B standard.
- Informative LED diodes indicate:
 - Tx – yellow - output or input active (*Tx - red - output from ETH channel)
 - Rx – yellow - output or input active (*Rx - green - input to ETH channel)



Note

Green LED **Tx** and yellow LED **Rx** flash simultaneously. The informations marked (*) are valid for hw version produced until 07/2008.

- 100 – yellow - if lit the 100Base-TX net is indicated otherwise is 10Base-T
- LINK – green - indicates correctly connected link
- F.D. – green - indicates full duplex operation
- The direct cable serves for connecting to the Ethernet network via the hub (repeater) or switch-hub (router).
- A crossed cable serves for connecting only two devices - MR400-MC100, MR400-PC, etc.

The ETH module consumption is 30 mA (60 mA until 07/2008).

The following table contains connector connections and colours of conductors. For the crossed cable the order of conductors on one side is the same as for the direct cable.

Tab. 3.4: Table of Ethernet to cable connector connections

PIN	Signal	Direct cable	Crossed cable
1	TX+	white - orange	white - green
2	TX-	orange	green
3	RX+	white - green	white - orange
4	—	blue	blue
5	—	white - blue	white - blue
6	Rx-	green	orange
7	—	white - brown	white - brown
8	—	brown	brown

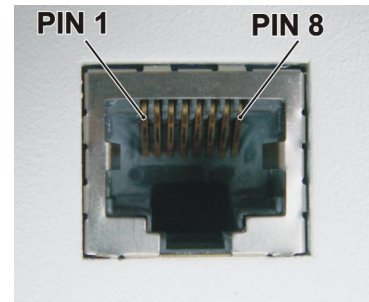

Fig. 3.4: RJ-45F

3.4. Analog and Digital Inputs and Outputs

The module of analog and digital inputs and outputs (ADIO) is designed for :

- creating 20 mA current loops
- switching loads supplied with DC and AC current
- scanning digital signals

Each functional group of terminals is galvanically separated from the rest of the device as shown on the internal layout diagram for the ADIO module on the image below:

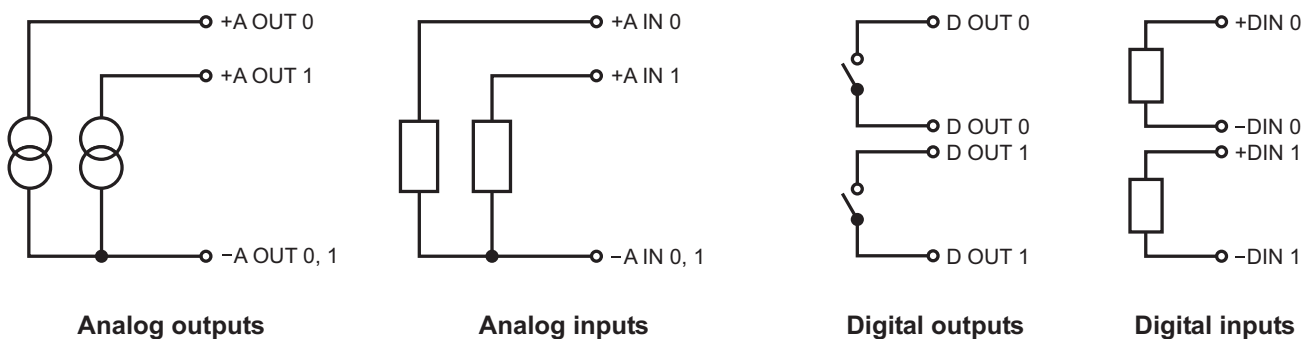

Fig. 3.5: Wiring diagrams for analog and digital inputs and outputs

3.4.1. Labelling

Individual terminals of terminal blocks are labelled:

- Connector A OUT - analog outputs
- Connector A IN - analog inputs
- Connector D OUT - digital outputs
- Connector D IN - digital inputs
- Terminal UP this clamps pair is not used

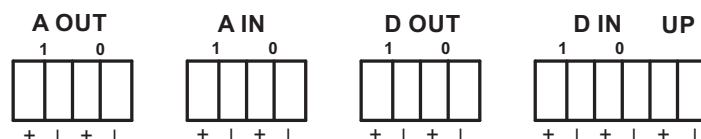

Fig. 3.6: Description of analog and digital inputs and outputs

3.4.2. Parameters

Tab. 3.5: Table of digital and analog input and output parameters

2 × optically separated digital output	<ul style="list-style-type: none"> – bipolar SSR switch design – voltage for supplying load max. 30 V DC, 24 V AC – switched current typically 300 mA – resistance in on state max. 1 Ω – protection against current overload in on state – protection against overvoltage in off state 	passive
2 × optically separated digital input	<ul style="list-style-type: none"> – passive optical element design – input voltage 0–2,3 V will be evaluated as log. 0 – input voltage 2–30 V will be evaluated as log. 1 – max. value of input voltage 30 V 	passive
2 × optically separated analog output	<ul style="list-style-type: none"> – current source 4–20 mA – load resistance max. 250 Ω – settings accuracy better than 0.1 % 	active
2 × optically separated analog input	<ul style="list-style-type: none"> – sensitivity 0–20 mA (or after sw configuration 4–20 mA) – accuracy of measured values better than 0.1 % – input resistance 60 Ω – no protection against current overload – max. value of input current 50 mA 	passive

Analog inputs 0 and 1 have - (minus) terminals connected and galvan. separated from router GND.

Analog outputs 0 and 1 have - (minus) terminals connected and galvan. separated from router GND.

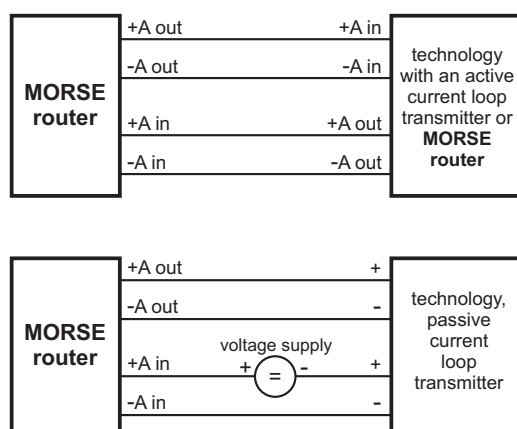

The MORSE router used in the diagram showing examples of wiring can, of course, be replaced by any MORSE system equipment (e.g. MD160, MX 160, MWxxx, MRxxx, MC100, MG100i, ...)

Fig. 3.7: Examples of wiring analog inputs and outputs

3.5. Supply Connector

Terminals of this connector are labelled in the standard manner. Only DC voltage in the range from 10.8 to 15.6 V can be connected. Connecting higher voltage may damage the radio modem.

Terminal PI (power indicator) - if the radio modem is fed from the MS2000 power supply information about supply method from source clamp MAIN PWR OFF can be lead:

- level TTL1 or unconnected clamp - network supply
- level TTL0 or grounded clamp - battery supply

Maximal supply cable length is 3 m.

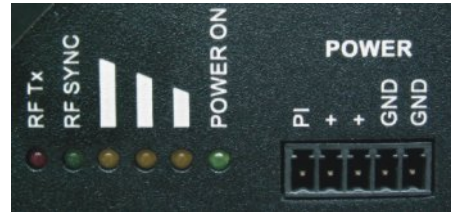

Fig. 3.8: Power connector & information LED

3.6. Information LED

Information LED diodes next to the supply connector:

- RF Tx — radio modem transmits RF frequency into antenna
- RS SYNC — radio modem received message header which was determined for it
- Three following LED (signal strength):

ON	ON	ON	RSS -85dBm and stronger
OFF	ON	ON	RSS -85 až -95dBm
OFF	OFF	ON	RSS -95 až -115dBm
OFF	OFF	OFF	RSS -115dBm and weaker

- POWER ON — radio modem is correctly supplied

3.7. Service Connector

The service connector RJ-12 serves for short-term connections of the service cable during local adjustment of MORSE router parameters. Upon attaching the connector (connecting to the RS232 link (RxD,TxD, GND)) the router automatically switches to service mode and the module slot 1 disconnects. Slots numbering see section Section 3.8, “View of Radio Modem”.

Tab. 3.6: Table of service connector connections

1	AF_OUT	output of modulation from RF part of router
2	SER_RxD	RS232 RxD output from router
3	SER_TxD	RS232 TxD input to router
4	MOD_BSB	input modulation to radio part of router
5	GND	ground
6	PTT	keying of TX carrier waves for service purposes



Fig. 3.9: Service connector



Important

ATTENTION! The service mode is not suitable for normal operation

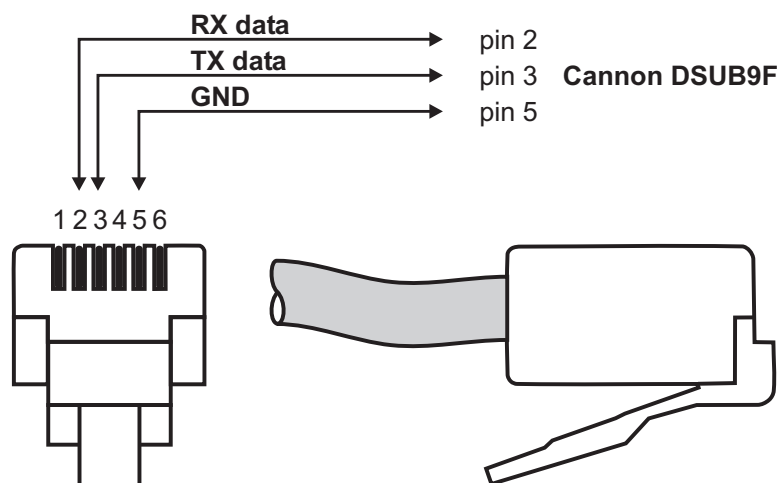

Fig. 3.10: Service cable connector connections

3.8. View of Radio Modem

The only difference in appearance between the controller and the radio modem is the type designation badge and the absence of an antenna connector - see the following image.

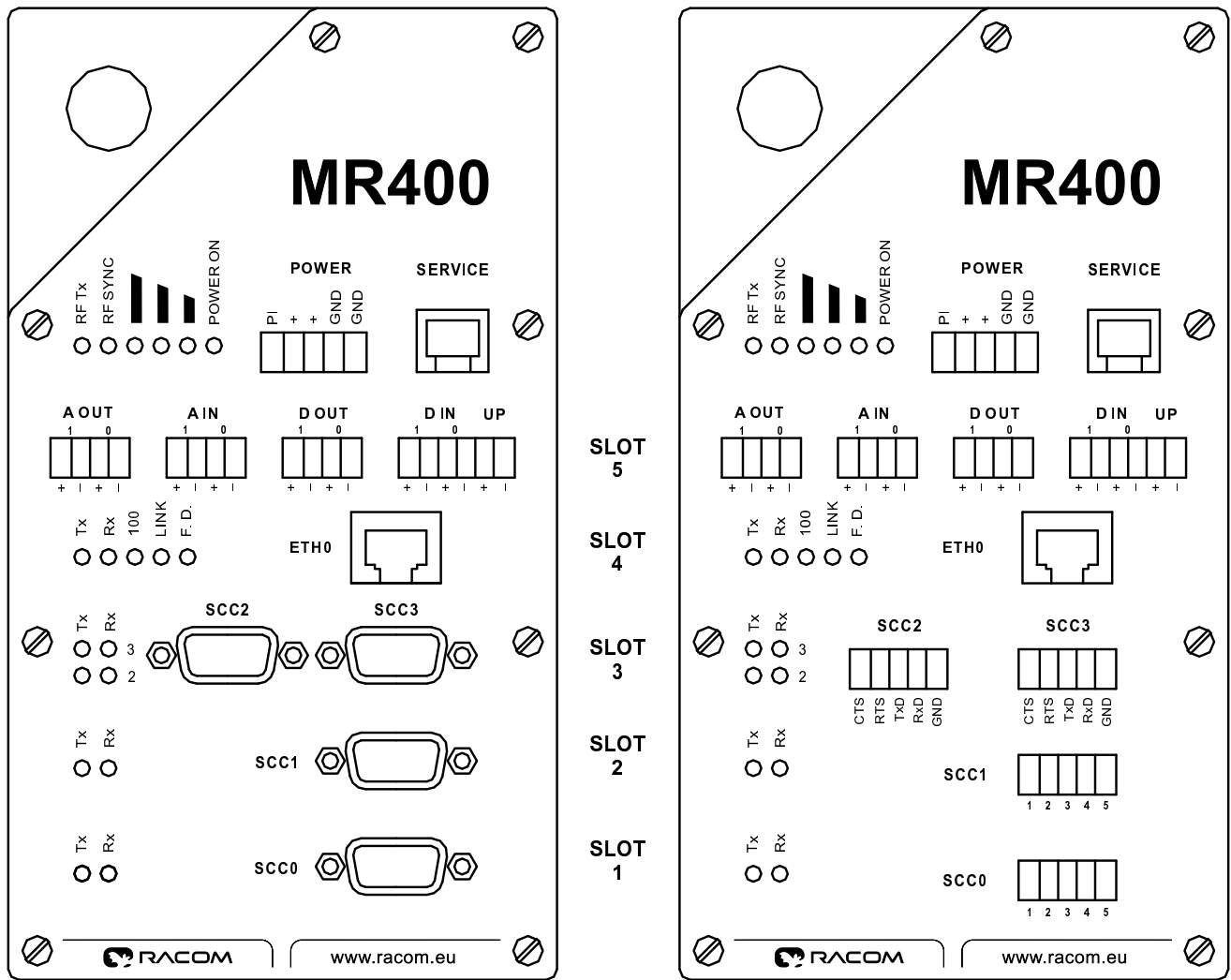

Fig. 3.11: View of radio modem — description of connectors, model with DSUB (Canon) connectors and with terminals, numbering of slots

Tab. 3.7: Slot options

Optional modules	
slot 5	ADIO (analog and digital inputs and outputs)
slot 4	Ethernet 10/100 Mbps
slot 3	2×RS232
slot 2	RS232 or galv.sep. RS232 or RS422/RS485
slot 1	

4. Table of Technical Parameters

Tab. 4.1: Table of technical parameters MR400, MR300, MR160

Frequency range	MR160: 135–175 MHz
	MR300: 290–350 MHz
	MR400: 350–470 MHz
Modulation type	4-state FSK
Channel spacing	25 kHz or 12.5 kHz
Means of setting working frequency	software in range +3.2 MHz from base frequency
Switching time transmitting/receiving	< 1.5 ms
Receiver sensitivity for BER 10 ⁻³	better than -107 dBm
Software adjustable output power ¹⁾	0.1–5 W
	0.1–25 W type of construction P
Max. modulation rate for transmitting	21.68 kbit/s in 25 kHz channel
	10.84 kbit/s in 12.5 kHz channel
Optional modules	
	slot 5 ADIO (analog and digital inputs and outputs)
	slot 4 Ethernet 10/100 Mbps
	slot 3 2×RS232
	slot 2 RS232 or galv.sep. RS232 or RS422/RS485
Antenna connector	N
MTBF(Mean Time Between Failure)	> 500.000 hours (> 50 years)
Supply nominal voltage	13.8 V
Supply voltage range	10.8–15.6 V
Idle consumption (Rx) ²⁾	380 mA + modules: (Eth. 30 mA, ADIO 50 mA, SCC 5 mA)
Transmission consumption (Tx) ²⁾	1.3 A / 1 W; 2.0 A / 5 W; 5.5 A / 25 W
Consumption in SLEEP mode	2.5 mA
Operating range of temperature	-30 to +70 °C (-22 to +158 °F)
Humidity	5 to 95% non-condensing
Storage range of temperature	-40 to +85 °C (-40 to +185 °F)
Mechanical dimensions	208×108×63 mm (71 mm DIN rail including)
	208×108×67 mm type of construction P
Spacing of fastening holes	198×65 mm, ø 4.8 mm
Weight	1.3 kg; 1.5 kg type of construction P

1) Availability of specific types and frequencies check here¹, please. Presently these types² are under mass production.

2) Approximate values dependent on frequency and modem type.

¹ <http://www.racom.eu/eng/products/rfp.html>

² <http://www.racom.eu/eng/products/radio-modems-mr400.html#specifications>

Tab. 4.2: Standards complied

Radio parameters	ETSI EN 300 113-2 V1.3.1, FCC part 90, RSS 119
EMC (Electromagnetic Compatibility)	ETSI EN 301 489-5 V 1.3.1; ETSI EN 300 113-1 V 1.5.1
Electrical safety	CSN EN 60 950:2001
Wheeled vehicle usage	UN Regulation No.10 (EHK No.10)
Human exposure electromagnetic fields	CSN EN 50 385, CSN EN 50 383

Tab. 4.3: Railway Safety Appliance Standards Regulations

Electronic appliances in railway vehicles	CSN EN 50155 ed. 2 nd : 2002. art. 10.2.8.2 CSN EN 50121 art. 7: tab. 3 and 4
EMC (Electromagnetic Compatibility)	CSN EN 50121-3-2 art. 8
Vibrations and beats	CSN EN 61373

Upon installation in railway vehicles, where there is a high level of interference, special attention should be given to the communication interface. In such cases it is necessary to use shielded cables and correctly grounded twisted pairs.



Note

The standard CSN EN 50155 (Electronic equipment in railway vehicles) does not apply to analog inputs and outputs and to the interface in the 1st slot. Therefore they are not recommended for use, and in an environment specified according to this standard no warranty applies to their use.

5. Dimensional Diagram and Labeling Modems

Dimensional Diagram

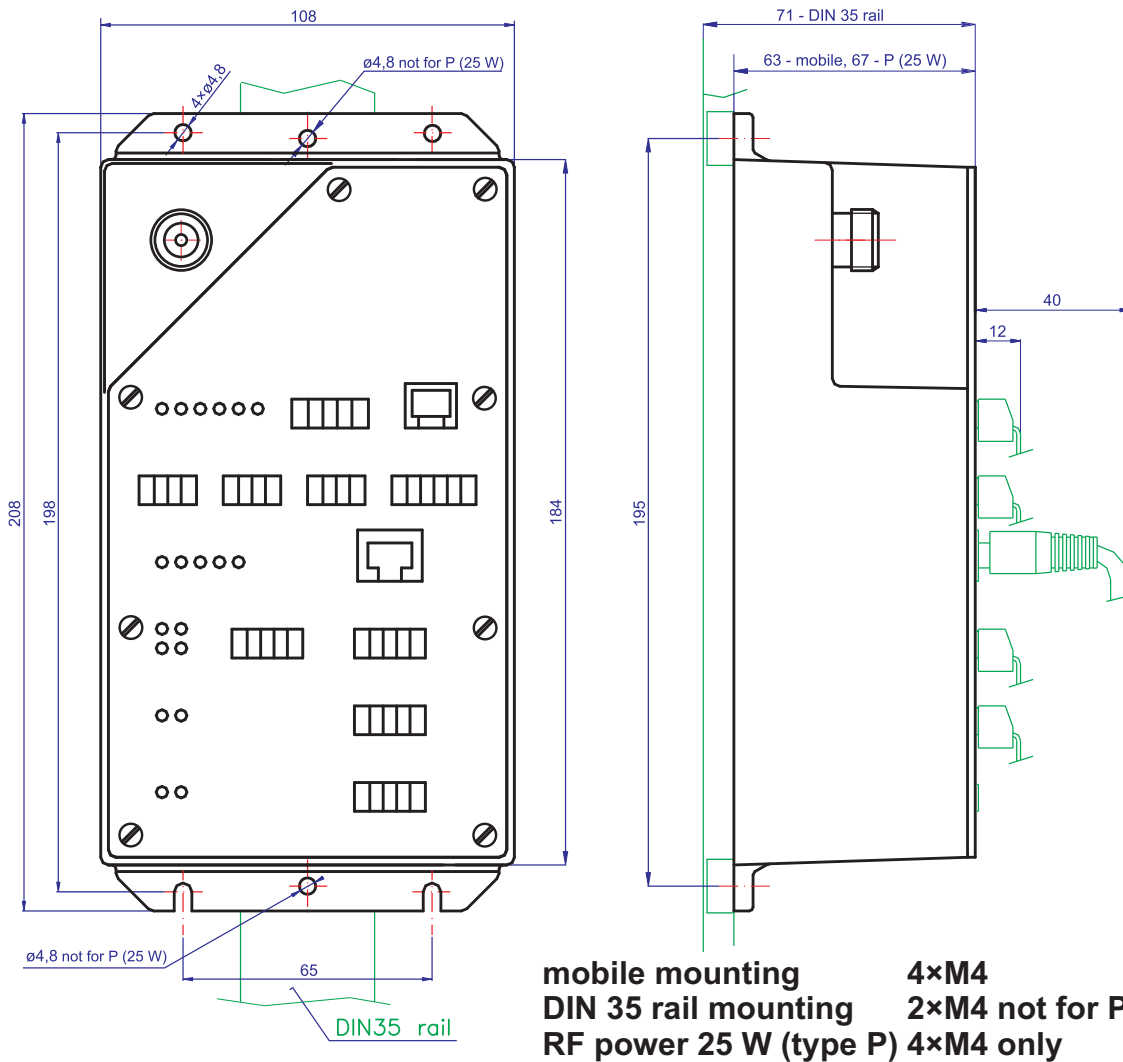

Fig. 5.1: Mounting dimensions of the radiomodem MR400, MR300 and MR160

The modem can be fastened by four screws M4 (for mobile application especially) or by the mounting rail DIN35 (stable applications). The flexible clamps mounted in the central holes are used for fastening on the DIN35 rail.

For the high-performance P model the modem is mounted on the back wall to ensure sufficient cooling of the modem. In this case 4x M4 screws are used for mounting purposes. There are no centre holes in the P version for attachment to a DIN rail.

Labelling Radio Modems

is described in next table:

MORSE components production code radiomodems profi narrowband

RADIO CHANNEL AND CASE VERSION:

SCC with Cannon DSUB9		- C
SCC with screw terminals		- S
SCC not used		- N
Frequency step	12.5 kHz	- 4
	10.0 kHz	- 3
	6.25 kHz	- 2
Channel bandwidth	25.0 kHz	- 2
	12.5 kHz	- 1

For equipment series: **MR400**
MR300
MR160
MD160

CASING

4xM4 screws or 2x DIN rail clips	- M
Short, for DIN rail only, obsolete	- S
RF power 25W	- P

Base Tx frequency, MHz

Half-duplex radio- R
Full-duplex radio- D

MORSE
PROFI

DIGITAL AND ANALOG CHANNELS:

number of Analog outputs		
number of Analog inputs		
Analog input and output 0 - 20 mA	- A	
An input 0 - 1240 mV, An output 0 - 20 mA - V		
Analog I/O not used	- empty	
number of Digital outputs		
number of Digital inputs		
Digital I/O used	- D	
neither Dig nor An I/O are used	- N	

MR425.0M24C-N-485I-232-E-D22A22

SETTING OF MODULE POSITION:

(from bottom edge of case)

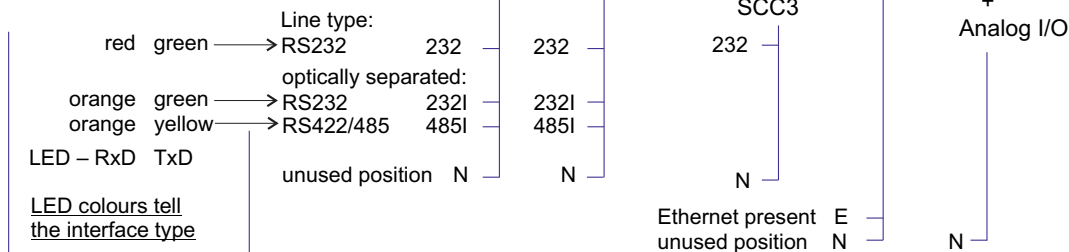

LED colours tell the interface type

Comment - radiomodem is the DCE equipment - both data output RS232 pin and LED are labeled Rx D.

Base frequency labelling options:

MR: 428.2	= base freq. 428.2 MHz, both Tx and Rx
MD: 155.0 / 159.6	= base freq. Tx = 155.0 MHz, Rx = 159.6 MHz
159.6 / 155.0	= base freq. Tx = 159.6 MHz, Rx = 155.0 MHz

Typical example of bandwidth/freq. step:

before 12/2008	MR425.0M2C-...
after 12/2008	MR425.0M24C-...
	MR425.0M1C-...
	MR425.0M14C-...

The standard freq. step is 12.5 kHz, exceptionally 6.25 kHz or 10 kHz.

Examples:

MR428.0M24C-N-N-232-E-D22A22

= MORSE half-duplex radio modem, base frequency 428,000 MHz, bandwidth 25 kHz, freq.step 12,5 kHz, casing with flanges for screws and/or DIN rail clips, SCC with Cannon connectors, SCC2 - RS232, SCC3 - RS232, Ethernet, Digital input 2x, Digital output 2x, An input 20mA 2x, An output 20mA 2x

MR425.0M14S-N-485I-232-E-N

= MORSE half-duplex radio modem, base frequency 425,0 MHz, bandwidth 12,5 kHz, freq.step 12,5 kHz, casing with flanges for screws and/or DIN rail clips, SCC connectors with screw terminals, SCC1 - RS485, optically separated, SCC2 - RS232, SCC3 - RS232, Ethernet

07 2014

6. Modem installation

6.1. General description of installation

Racom routers are built into a robust metal case and are suitable for applications which place them in various environments from air-conditioned offices to heavy industry factories. To a certain extent the method of installation needs to be adapted to this. All information in this chapter describes the standard method of installation for normal industrial applications, which has been derived from valid regulations for such equipment and also from the long-term experience of our engineers. In the case of larger-scale networks and more complicated applications we recommend that users order a project assessment from Racom, or a partner company, which should consist of careful measurements of the strength and quality of a signal and an assessment of the conditions for the propagation of radio waves.

Each radio equipment must comply with operating conditions for the given frequency band in the country in which it is operated and the person running the equipment is responsible for this.

For reliable operation of routers it is important to ensure that all equipment, for which data is transmitted through the router, is connected correctly. Also ensure the antenna is correctly connected and installed, a suitable and safe supply of electricity is provided, equipment is mounted correctly, and that all corresponds to the given operating conditions, without a negative influence on the specific properties of our equipment. A description and wiring of individual connectors and interfaces is described in the connectors chapter.

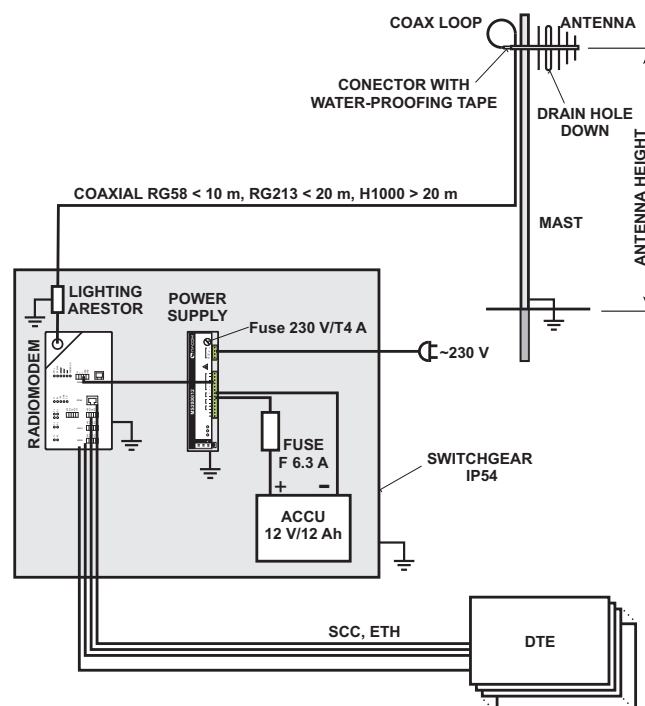

Fig. 6.1: Example of a typical installation of a data network radio point

6.2. Antenna installation

Optimum installation of the antenna is influenced by a number of factors. The topology of the radio network, the separation of radio points, the terrain profile between them, and conditions for signal

propagation all influence the type of antenna to be used and where it should be located. Sometimes the appearance of the structure on which the antenna is to be located and the possibility of its damage in publicly accessible places should also be taken into consideration. Generally it can be said that for point-to-point type connections directional antennas are used, and for more remote points and points with a poorer signal multilink directional antennas with greater gain are used. The height of the antenna above ground level may improve the quality of the signal. The standard height of approx. 5 m can be increased severalfold, but always in consideration of the length of the antenna lead, because each coaxial cable used has its own defined attenuation. For longer leads coaxial cables with lower attenuation are used and generally these have a larger cross-section, worse mechanical properties and are more expensive. When using external antennas we recommend protecting the radio modem with overvoltage protection on the coaxial cable.

We recommend to use vertical polarization for all radio modem networks.

Racom radio equipment in typical installations comply with applicable standards for human exposure to RF electromagnetic fields, namely with standard EN 50385: 2002. The minimal safe distance is ensured by the antenna position on a mast. When special installation is required, the conditions of the standard above have to be met. The distance between the persons and antenna minimal 5 m comply with applicable standards for human exposure of general public to RF electromagnetic fields, namely with standard EN 50385: 2002. It is valid for all power levels and all antenna types which firm Racom provides.

6.3. Power supply

A power supply meeting the specified parameters (see the table of technical parameters) needs to be used for supplying radio routers. We recommend using an MS2000¹ power supply or other power supply of MORSE system², which has been developed specially for these purposes, and where necessary is capable of switching to a back-up battery, as well as monitoring its state of charge, and also charging.

6.4. Technology connection

The Data Terminal Equipment, a programmable controller, a PC or any other device communicating over the radio network, has to be connected to the router by a data cable to the serial or the Ethernet interface according to the respective standard. These interfaces are described in detail in the chapter Connectors.

6.5. Mechanical mounting

Radio routers can be mounted either to a mounting plate using screws or by mounting on a DIN rail. See the table of technical parameters for the dimensions and spacing separation of mounted parts. Generally for industrial applications³ the radio routers are mounted together with the overvoltage protection, power supply, and back-up battery into a switchboard with IP54 protection.

¹ <http://www.racom.eu/eng/products/ms2000.html>

² <http://www.racom.eu/eng/products/supplies.html>

³ <https://www.racom.eu/eng/references/references.html>

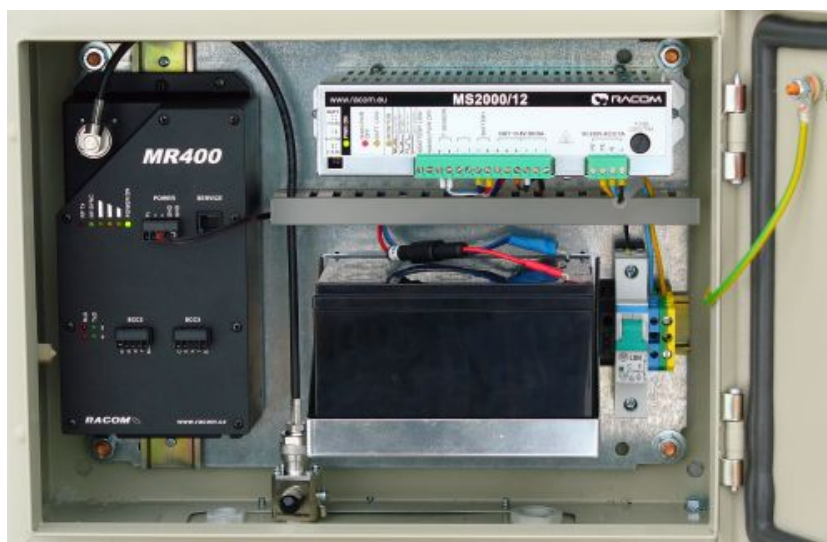

Fig. 6.2: Example of the layout of equipment in a switchboard

7. Conditions for MR400 Operation

7.1. Important Warning

RACOM s. r. o. (hereinafter referred to as RACOM) is the exclusive owner of all rights to this operator manual. All rights reserved. Any duplication of this manual in any way, shape or form, or translation to any other language (without the prior written consent of the owner of the rights) is strictly forbidden. RACOM retains the right to make changes to the technical specification or functions of this product or to terminate production of this product, or to terminate service support of this product without advance written notice to the customer. RACOM firmware is available free of charge. Source code is the property of RACOM and is not available to any user. Any commercial use of the software with this licence is strictly forbidden. Changes to software and documentation are forbidden. RACOM firmware is released with the intention that it will be useful, however without any specific guarantees.

Under no circumstances is the Racom or any other company or person responsible for incidental, accidental or related damage arising as a result of the use of this product. The manufacturer shall not provide the user with any form of guarantee containing assurance of the suitability and applicability for its application. RACOM products are not developed, designed or tested for use in equipment which directly affects the health and life functions of humans or animals and neither as part of other important equipment, and RACOM does not provide a guarantee if company products are used in such equipment.

7.2. Conditions of Liability for Defects and Instructions for Safe Operation of Equipment.

Please read these safety instructions carefully before using the product:

- Liability for defects does not apply to any product that has been used in a manner which conflicts with the instructions contained in this operator manual, or if the case in which the radio modem is located has been opened, or if the equipment has been tampered with.
- The radio modem can only be operated on frequencies stipulated by the body authorised by the radio operation administration in the respective country and cannot exceed the maximum permitted output power. RACOM is not responsible for products used in an unauthorised way.
- Equipment mentioned in this operator manual may only be used in accordance with instructions contained in this manual. Error-free and safe operation of this equipment is only guaranteed if this equipment is transported, stored, operated and controlled in the proper manner. The same applies to equipment maintenance.
- In order to prevent damage to the radio modem and other terminal equipment the supply must always be disconnected upon connecting or disconnecting the cable to the radio modem data interface. It is necessary to ensure that connected equipment has been grounded to the same potential. Before connecting the supply cable the output source voltage should be disconnected.
- Only undermentioned manufacturer is entitled to repair any devices.
- CAUTION ! Risk of explosion on replacing the incorrect type of battery in the modem part. Dispose of used batteries in accordance with their manufacturer's instructions. We recommend that lithium back-up batteries are replaced by RACOM service agents.
- For ensuring the appropriate protection the manufacturer recommends powering the radio modem from an MS2000 power supply with short circuit current protection which acts as means of current

protection for output circuits. If another power supply is used fuses, overcurrent protection or similar protective components should be used.

- In threshold mode the radio modem is capable of operation at an ambient temperature of up to 70 °C. In such cases the temperature of the surface of the radio modem may reach high values, particularly in the case of the high end model "P" – the modem temperature may be up to several tens of degrees hotter than the ambient temperature, and therefore under these conditions the equipment needs to be protected against accidental contact. We recommend that operators who plan on using this threshold mode stick a warning sticker, in accordance with IEC 60417-5041 (DB:2002-10), on a visible part of the radio modem, or attach a sticker with the following text:

CAUTION!
HOT SURFACE
DO NOT TOUCH



Fig. 7.1: Warning sticker IEC 60417-5041 (DB:2002-10)

7.3. RoHS and WEEE compliance

The routers are fully compliant with the European Commission's RoHS (Restriction of Certain Hazardous Substances in Electrical and Electronic Equipment) and WEEE (Waste Electrical and Electronic Equipment) environmental directives.

RoHS  Restriction of hazardous substances (RoHS)

The RoHS Directive prohibits the sale in the European Union of electronic equipment containing these hazardous substances: lead, cadmium, mercury, hexavalent chromium, polybrominated biphenyls (PBBs), and polybrominated diphenyl ethers (PBDEs).

End-of-life recycling programme (WEEE)



The WEEE Directive concerns the recovery, reuse, and recycling of electronic and electrical equipment. Under the Directive, used equipment must be marked, collected separately, and disposed of properly. Racom has instigated a programme to manage the reuse, recycling, and recovery of waste in an environmentally safe manner using processes that comply with the WEEE Directive (EU Waste Electrical and Electronic Equipment 2002/96/EC).

Battery Disposal—This product may contain a battery. Batteries must be disposed of properly, and may not be disposed of as unsorted municipal waste in the European Union. See the product documentation for specific battery information. Batteries are marked with a symbol, which may include lettering to indicate cadmium (Cd), lead (Pb), or mercury (Hg). For proper recycling return the battery to your supplier or to a designated collection point.

7.4. Product Conformity

Hereby, RACOM s. r. o., declares that these MR400, MR300 and MR160 radio modems are in compliance with the essential requirements and other relevant provisions of Directive 1999/5/ES. This equipment therefore bears the CE marking. The warning exclamation mark in the circle marks the radio modem as class 2 equipment denoting radio equipment with possible limitations or with requirements on authorisation to use radio equipment in certain countries.



Finnish

Racom s. r. o. vakuuttaa täten että MR400 (MR300, MR160) radiomodeemi tyyppinen laite on direktiivin 1999/5/EY oleellisten vaatimusten ja sitä koskevien direktiivin muiden ehtojen mukainen.

Dutch

Hierbij verklaart Racom s. r. o. dat het toestel MR400 (MR300, MR160) in overeenstemming is met de essentiële eisen en de andere relevante bepalingen van richtlijn 1999/5/EG.

Bij deze verklaart Racom s. r. o. dat deze MR400 (MR300, MR160) voldoet aan de essentiële eisen en aan de overige relevante bepalingen van Richtlijn 1999/5/EC.

French

Par la présente Racom s. r. o. déclare que l'appareil MR400 (MR300, MR160) est conforme aux exigences essentielles et aux autres dispositions pertinentes de la directive 1999/5/CE

Par la présente, Racom s. r. o. déclare que ce MR400 (MR300, MR160) est conforme aux exigences essentielles et aux autres dispositions de la directive 1999/5/CE qui lui sont applicables

Swedish

Härmed intygar Racom s. r. o. att denna MR400 (MR300, MR160,) står i överensstämmelse med de väsentliga egenskapskrav och övriga relevanta bestämmelser som framgår av direktiv 1999/5/EG.

Danish

Undertegnede Racom s. r. o. erklærer herved, at følgende udstyr MR400 (MR300, MR160) overholder de væsentlige krav og øvrige relevante krav i direktiv 1999/5/EF

German

Hiermit erklärt Racom s. r. o., dass sich dieses MR400 (MR300, MR160) in Übereinstimmung mit den grundlegenden Anforderungen und den anderen relevanten Vorschriften der Richtlinie 1999/5/EG befindet". (BMW i)

Hiermit erklärt Racom s. r. o. die Übereinstimmung des Gerätes MR400 (MR300, MR160) mit den grundlegenden Anforderungen und den anderen relevanten Festlegungen der Richtlinie 1999/5/EG. (Wien)

Greek

ΜΕ ΤΗΝ ΠΑΡΟΥΣΑ Racom s. r. o. ΔΗΛΩΝΕΙ ΟΤΙ ΜR400 (ΜR300, ΜR160) ΣΥΜΜΟΡΦΩΝΕΤΑΙ ΠΡΟΣ ΤΙΣ ΟΥΣΙΩΔΕΙΣ ΑΠΑΙΤΗΣΕΙΣ ΚΑΙ ΤΙΣ ΛΟΙΠΕΣ ΣΧΕΤΙΚΕΣ ΔΙΑΤΑΞΕΙΣ ΤΗΣ ΟΔΗΓΙΑΣ 1999/5/ΕΚ

Italian

Con la presente Racom s. r. o. dichiara che questo MR400 (MR300, MR160) è conforme ai requisiti essenziali ed alle altre disposizioni pertinenti stabilite dalla direttiva 1999/5/CE.

Spanish

Por medio de la presente Racom s. r. o. declara que el MR400 (MR300, MR160) cumple con los requisitos esenciales y cualesquiera otras disposiciones aplicables o exigibles de la Directiva 1999/5/CE

Portuguese

Racom s. r. o. declara que este MR400 (MR300, MR160) está conforme com os requisitos essenciais e outras disposições da Directiva 1999/5/CE.

...the broadest narrowband money can buy



Declaration of Conformity – MR400

- in accordance with **1999/5/EC** Directive of the European Parliament and of the Council of 9th of March 1999 on radio equipment and telecommunications terminal equipment and the mutual recognition of their conformity.

Manufacturer: RACOM
Address: Mirova 1283, 592 31 Nove Mesto na Morave, Czech Republic
VAT No.: CZ46343423
Product: MR400
Purpose of use: Radio modem

CE 1355

Notified Body Opinion:

According to: European Union Directive 1999/5/EC – ANNEX IV
Document No.: 00011/171/5/2004
Issued by: Vyskumny ustav spojov Banska Bystrica, Slovakia on 7th of February 2005
Notified Body: No. 1355

We, the manufacturer of the above mentioned product, hereby declare that:

- all essential radio test suites have been carried out and that the above named product is in conformity to all the essential requirements of the European Union directive **1999/5/EC** – ANNEX IV for equipment working in mode listen before transmit (the technical documentation relevant to the abovementioned equipment can be made available for inspection on application to manufacturer);
- the above named product is safe on condition of usage mentioned in the operating manual.

The product is compliant with the following standards and/or other normative documents:

Spectrum (art 3.2) ETSI EN 300 113–2
EMC (art 3.1.b) ETSI EN 301 489–1
Safety (art 3.1.a) CSN EN 60950–1

The above named equipment is classified as a Class 2 radio equipment and it is marked with Equipment Class Identifier in accordance with Commission Decision 2000/299EC.

Nove Mesto na Morave, 22th of August 2005
Jiri Hruska, Managing Director

RACOM s.r.o. • Mirova 1283 • 592 31 Nove Mesto na Morave • Czech Republic
Tel.: +420 565 659 511 • Fax: +420 565 659 512 • E-mail: racom@racom.eu

www.racom.eu

Fig. 7.2: Declaration of Conformity – MR400

...the broadest narrowband money can buy



Declaration of Conformity – MR300

- in accordance with **1999/5/EC** Directive of the European Parliament and of the Council of 9th of March 1999 on radio equipment and telecommunications terminal equipment and the mutual recognition of their conformity.

Manufacturer: RACOM
Address: Mirova 1283, 592 31 Nove Mesto na Morave, Czech Republic
VAT: CZ46343423
Product: MR300
Purpose of use: Radio modem



We, the manufacturer of the above mentioned product, hereby declare that:

- all essential radio test suites have been carried out and that the above named product is in conformity to all the essential requirements of the European Union directive **1999/5/EC – ANNEX IV** for equipment working in mode listen before transmit (the technical documentation relevant to the abovementioned equipment can be made available for inspection on application to manufacturer);
- the above named product is safe on condition of usage mentioned in the operating manual.

The Declaration of Conformity is based on the following documents:

Test specification:	Document No.:	Date of issue:	Laboratory:
ETSI EN 300 113-1 V1.5.1	RA1217	12.03. 2007	TESTCOM Praha, CZ
ETSI EN 301 489-5 V1.2.1	17/04	26.02. 2004	TESTCOM Praha, CZ
EN 60950	EB 1265	10.03. 2004	TESTCOM Praha, CZ

The above named equipment is classified as a Class 2 radio equipment and it is marked with Equipment Class Identifier **I** in accordance with Commission Decision 2000/299EC.

Nove Mesto na Morave, 22th of August 2006
 Jiri Hruska, Managing Director

RACOM s.r.o. • Mirova 1283 • 592 31 Nove Mesto na Morave • Czech Republic
 Tel.: +420 565 659 511 • Fax: +420 565 659 512 • E-mail: racom@racom.eu

www.racom.eu

Fig. 7.3: Declaration of Conformity – MR300

...the broadest narrowband money can buy



Declaration of Conformity – MR160

- in accordance with **1999/5/EC** Directive of the European Parliament and of the Council of 9th of March 1999 on radio equipment and telecommunications terminal equipment and the mutual recognition of their conformity.

Manufacturer: RACOM
Address: Mirova 1283, 592 31 Nove Mesto na Morave, Czech Republic
VAT No.: CZ46343423
Product: MR160
Purpose of use: Radio modem

CE 1355 ⓘ

Notified Body Opinion:

According to: European Union Directive 1999/5/EC – ANNEX IV
Document No.: 00002/171/5/2006
Issued by: Vyskumny ustav spojov Banska Bystrica, Slovakia on 6th of February 2006
Notified Body: No. 1355

We, the manufacturer of the above mentioned product, hereby declare that:

- all essential radio test suites have been carried out and that the above named product is in conformity to all the essential requirements of the European Union directive **1999/5/EC – ANNEX IV** for equipment working in mode listen before transmit (the technical documentation relevant to the abovementioned equipment can be made available for inspection on application to manufacturer);
- the above named product is safe on condition of usage mentioned in the operating manual.

The product is compliant with the following standards and/or other normative documents:

Spectrum (art 3.2) ETSI EN 300 113–2
EMC (art 3.1.b) ETSI EN 301 489–1
Safety (art 3.1.a) CSN EN 60950–1

The above named equipment is classified as a Class 2 radio equipment and it is marked with Equipment Class Identifier ⓘ in accordance with Commission Decision 2000/299EC.

Nove Mesto na Morave, 14th of July 2006
Jiri Hruska, Managing Director

RACOM s.r.o. • Mirova 1283 • 592 31 Nove Mesto na Morave • Czech Republic
Tel.: +420 565 659 511 • Fax: +420 565 659 512 • E-mail: racom@racom.eu

www.racom.eu

Fig. 7.4: Declaration of Conformity – MR160

7.5. Country of Origin



Country of Origin Declaration

Manufacturer: RACOM
Address: Mirova 1283, 592 31 Nove Mesto na Morave, Czech Republic
VAT No: CZ46343423

We, the manufacturer, hereby declare that Country of Origin of the MR radio series and its accessories is the Czech Republic, EU.

Part Number	Description
MC 100	Controller, modules according to spec.
MD 160 25W	160 MHz, 12.5 or 25 kHz, 25W, full-duplex, modules according to spec.
MR 160 25W	160 MHz, 12.5 or 25 kHz, 25W, half-duplex, modules according to spec.
MR 160 5W	160 MHz, 12.5 or 25 kHz, 5W, half-duplex, modules according to spec.
MR 300 5W	300 MHz, 12.5 or 25 kHz, 5W, half-duplex, modules according to spec.
MR 400 25W	400 MHz, 12.5 or 25 kHz, 25W, half-duplex, modules according to spec.
MR 400 5W	400 MHz, 12.5 or 25 kHz, 5W, half-duplex, modules according to spec.
MW 160 25W	160 MHz, 200 kHz, 25W, half-duplex, modules according to spec.
MX 160 25W	160 MHz, 200 kHz, 25W, full-duplex, modules according to spec.
MG 100	Cellular router, modules according to spec.
MS 2000/12	230 V AC / 13.8 V DC, intelligent back-up
MS 2000/24	230 V AC / 24 V DC, intelligent back-up
MSU 120	Arbitrary solar panel / 14.7 V DC
DCC 24	20–60 V DC / 13.8 V DC

Nove Mesto na Morave, 1 of March 2014
 Jiri Hruska, CEO



RACOM s.r.o. • Mirova 1283 • 592 31 Nove Mesto na Morave • Czech Republic
 Tel.: +420 565 659 511 • Fax: +420 565 659 512 • E-mail: racom@racom.eu

www.racom.eu

ver. 1.1

Fig. 7.5: Country of Origin declaration

7.6. Limitations of Use

The MR400 radio modem has been developed for the frequency range 350 to 470 MHz, the MR300 for the frequency range 290 to 350 MHz and the MR160 for frequency 135 to 175 MHz . Specific frequencies are used for each country or region. A radio modem user must keep in mind that this radio device cannot be operated without the permission of the respective local radio spectrum administrator who provides a specific frequency for use and issues the appropriate permission for this. The MR400, MR300 and MR160 radio modems can be used in the following countries either based on a general permission agreement or on frequencies requiring a licence for operation. Country codes according to ISO 3166-1-Alpha-2 standard: AT, AU, BE, BR, BG, CA, HR, CZ, CY, DK, EE, FI, FR, DE, GR, HK, HU, IS, IE, IT, LV, LT, LU, MY, NL, NO, PL, RO, SG, SI, ZA, ES, SE, CH, GB and US.



Important

Users of MR400 radio modems in North America must be aware that because the 406.0 – 406.1 MHz frequency range is reserved only for the government the use of radio modems on these frequencies is strictly forbidden without proper permission.

Appendix A. Revision History

Revision 2.1	2005-03-11	Document converted to the XML format
Revision 2.2	2005-04-08	Overall review of document
Revision 2.3	2006-05-18	GPS module description supplemented
Revision 3.1	2006-10-12	Manuals for modems MR series and controller MC100 merged in common source XML file
Revision 4.0	2007-05-22	25 kHz bandwidth modems renamed to Narrowband High-performance (25 W) radiomodems supplemented Standards complied including Railway Safety Appliance Standards Regulations supplemented, Limitations of Use supplemented
Revision 4.1	2008-01-15	Manual renamed to Narrowband modems – PROFI MR400, MR300, MR160
Revision 4.2	2008-09-12	M-Bus module description supplemented
Revision 4.3	2008-11-07	The new version of the image „Mounting dimensions“ – type of construction P (25 W), a separate version of this image for the controller MC100
Revision 4.4	2008-11-12	T-port module description supplemented
Revision 4.5	2008-05-27	The introduction of more general term "Morse router" in the documentation (together with the term "Radiomodem") Revision history attached
Revision 4.6	2009-12-22	Radiomodem MR070 supplemented
Revision 4.7	2012-03-19	removed the T-port, patch temperature specifications table
Revision 4.8	2014-01-21	removed the M-Bus, MR070
Revision 4.9	2014-03-27	Added section Section 7.5, "Country of Origin"
Revision 4.10	2014-07-17	removed GPS module, completed MORSE code
Revision 4.11	2015-03-30	Added section Section 7.3, "RoHS and WEEE compliance"