

SAX / PAX Test Blocks & Probes

Reference Handbook

sax-reference-en v.58



SecuControl

Copyright Notice

All information provided in this document is the property of **SECUCONTROL** .

SECUCONTROL grants its customers or potential customers the right to download, copy, store and print this document for the sole purpose of assisting them in the correct application of the products mentioned in this document.

All other uses of this document are expressly prohibited.

Intellectual Property Notice

This publication contains proprietary information under protection of the following (among others) patents: DE 10 2005 025 108, DE 10 2008 016 388, US 7,271,357 and US 7,884,597.

Contents Disclaimer

Although the information and recommendations in this document are presented in good faith and believed to be correct as of publication date, **SECUCONTROL** makes no representations as to the completeness or accuracy thereof. In no event shall **SECUCONTROL** be responsible for damages of any nature resulting from the use of or reliance upon the contents of this document.

Continuous Improvements

Products developed by **SECUCONTROL** are continuously improved. The information in this document may, therefore, be out of date.

Please make sure you have the latest release of this document before proceeding by checking its name and revision code. This information is printed on the front cover of this document, underneath the title. The latest release of this document can be downloaded from www.secucontrol.com/downloads. Alternatively, you may contact **SECUCONTROL** at any of the addresses provided on the rear cover of this document.

Contents

1	Introduction	1
	The SAX / PAX Terminal / Test Block & Plug	1
	Key Features	1
	Applicable Models	1
	Unpacking	2
	Part Number and Manufacturing Date Location	2
	Safety Symbols	2
	General Safety Instructions	2
2	Principle of Operation	5
	Closed Circuit	5
	Open Circuit, Signal Injection	5
	Current Transformers	6
3	Application	7
	Schematic Symbols	7
	Typical Connection Schematic	8
4	Installation	9
	Wiring	9
	Mounting	10
	Drilling Plans	10
5	Operation	17
6	Technical Specifications	19
	Electrical	19
	Mechanical	20
	Dimensional Drawings SAX	21
	Dimensional Drawings PAX	26
7	Accessories	29
	Cases for PAX Test Probes	29
	Test Probes Set	29
	Disconnect Pins	30

Current Measurement Probe	30
Dust Covers for SAX Test Blocks	31
8 Spare Parts	33
Fitting Screws	33
9 Ordering Information	35
Available Configurations	35

1 Introduction

The SAX / PAX Terminal / Test Block & Plug

SAX is a surface mount terminal / test block combination for interfacing substation devices (protection relays, fault recorders, revenue meters, ...) to the voltage and current transformers and to other equipment on the system side of a power grid.

PAX is a test probe keyed to a particular SAX module type (currents, voltages ...). Once inserted into the corresponding test block, the PAX test probe isolates the substation devices from the system side equipment. Once the test probe is inserted the secondary injection can be performed.

Key Features

- Terminal block and test block in one - reducing panel space and wiring time needs
- Finger-safe test block and test probe increase safety during testing
- Test probes are keyed to the corresponding test blocks and help eliminate the most common human errors during testing - and their sometimes costly consequences
- Extremely low internal resistance ($< 2 \text{ m}\Omega$) helps reduce heat inside cabinets and panels
- Available from 4 to 20 pole configurations

Applicable Models

Information in this document applies to all SAX terminal / test blocks and PAX test probes manufactured after May 2012. A separate document is available for the 4600 series of standard configurations.

Unpacking

Unpack the product carefully and make sure that all pertinent parts like mounting screws (and dust covers, if included) are put aside so they will not be lost.

Check the contents against the packing list. If any of the contents listed are missing, please contact **SECUCONTROL** immediately (see contact information at the rear cover of this manual).

Examine the product for any shipping damage. If the product is damaged, notify the shipping company without delay. Only the consignee (the person or company receiving the unit) can file a claim against the carrier for shipping damage.

Part Number and Manufacturing Date Location

Part number and manufacturing date are stated on a label on the right side of the test block or test probe.

Safety Symbols

The following symbols are located on different parts of the equipment and in this manual:



Paragraphs marked with this symbol contain information which, if not properly followed, may cause damage to the equipment and/or installation.



Paragraphs marked with this symbol contain information which, if not properly followed, may cause personal injury or even death.

General Safety Instructions

Installation and operation of the products described in this manual is only to be performed by personnel that has been trained or is knowledgeable in substation protection, automation and control.

This instruction manual is an integral part of the scope of delivery and provides basic instructions for installation and operation of the equipment here described. Shall additional information be needed, please contact **SECUCONTROL** at any of the addresses provided on the rear cover of this document.



Do not disassemble the test block or test probe. Correct alignment of internal parts is critical in order to provide insulation and arch-avoidance.

The warranty will be void if the test block or test probe is disassembled (or otherwise handled inappropriately). SecuControl does not assume responsibility for any damages arising out of mishandling of our products, including test blocks / test probes that have been disassembled by parties other than SecuControl.



2 Principle of Operation

Closed Circuit

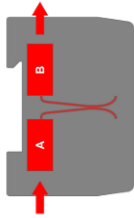

In the resting state the SAX test block's contacts are closed, signals from the system side (side A) are connected by flat springs to the panel devices (side B).

Open Circuit, Signal Injection

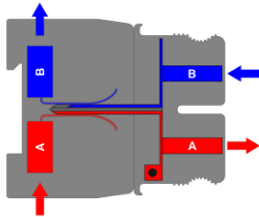

To open the test block's contacts, the PAX test probe is inserted into the SAX test block. In this situation, the devices in the panel (side B) are isolated from the system side (side A). Signals can be injected using the banana jacks in the front side of the PAX test probe.

2. PRINCIPLE OF OPERATION

Current Transformers

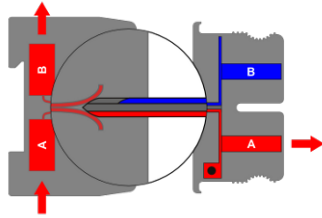

The PAX test probes automatically short-circuits the secondaries of current transformers. The short-circuiting happens before the contacts are open (“make-before-break”).

3 Application

Schematic Symbols

Following symbols are suggested in order to represent the SAX terminal / test block in schematic diagrams.

Symbol	Description	Length of plug fingers (Sequence of opening)
	Trip (single pole)	Long (Opens 1st)
	Signal, Voltage (single pole)	Short (Opens 2nd)
	Current (2-pole, 4-pole)	Short (Opens 2nd, after current shorting)

3. APPLICATION

Typical Connection Schematic

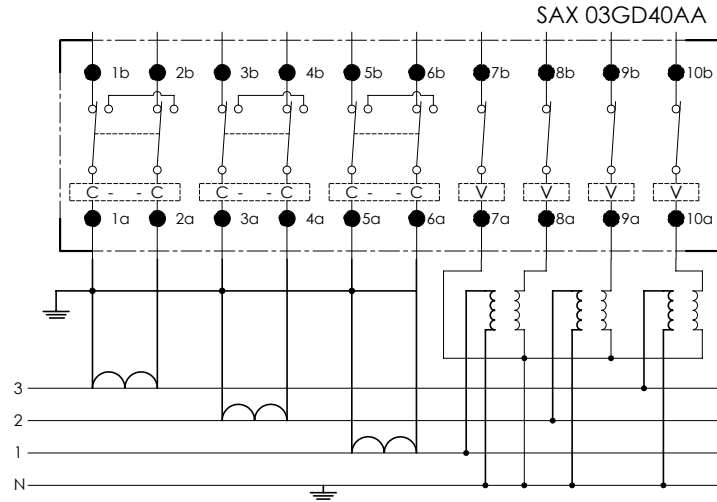

4 Installation

Wiring

Electrical connection terminals are located on the sides of the SAX terminal / test block. The connection terminals combine a screw in the center with a pressure plate, accepting ring cable lugs, stripped wire or other crimp connectors.

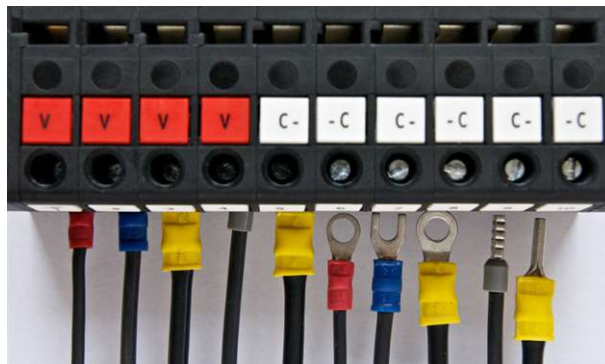

Recommended wire gauge is from 1,5 mm² (AWG 16) to 4 mm² (AWG 12).

CTs should be wired to the terminals provided for this purpose (in 2 or 4-pole combinations) to ensure automatic short circuiting upon insertion of PAX test probes or individual test probes into the SAX terminal / test block. The terminals designated for the connection of the CTs can typically be identified by the

C-	-C
----	----

 or

C-	-C-	-C-	-C
----	-----	-----	----

¹.

All "poles" (or test block modules) are continuously numbered (e.g. from 1 through 20 for a 20-pole SAX). The system side is indicated with the letter "a" and the device side with the letter "b".

SAX functionality requires that the **B-SIDE** (device side) of the test block must be connected with the device to be tested (e.g. protective relay), and the **A-SIDE** (system side) must be connected to the electrical system (e.g. CTs, PTs and breakers).



¹These custom labeling may show other symbols or use other colors.

4. INSTALLATION

Mounting

The SAX test block can be mounted in two different ways:

DIN Rail (35 mm) Mount

1. Using a 3 mm hex drive, unscrew the two screws located on the sides of the SAX test block as far as possible. The screws are captive and cannot be completely removed.

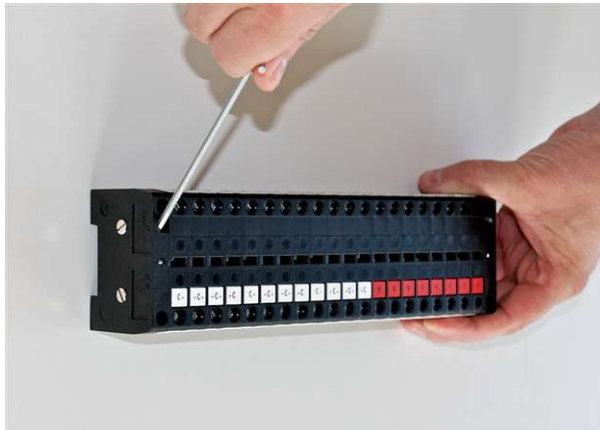

2. Fit the block on the DIN rail.
3. Tighten the screws.
4. Check if the block is securely fixed to the rail.

Surface Mount

Use the provided M4x50 screws to fix the SAX test block onto the panel. The screws should be tightened using a 3 mm hex drive.

Drilling Plans

Following figures represent the drilling plans to different models available. The drilling should forecast a M4 metric thread.

4-pole Models

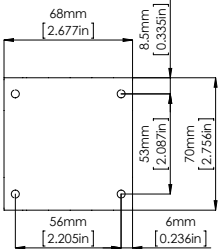

5-pole Models

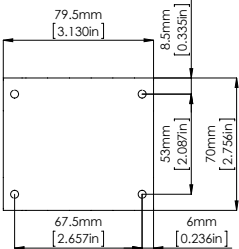

6-pole Models

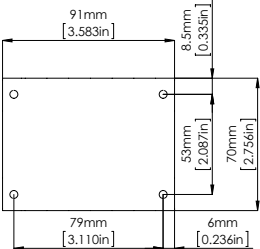

4. INSTALLATION

7-pole Models

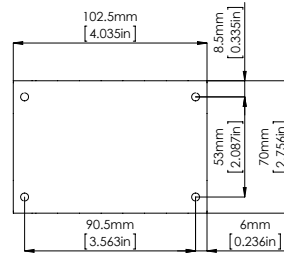

8-pole Models

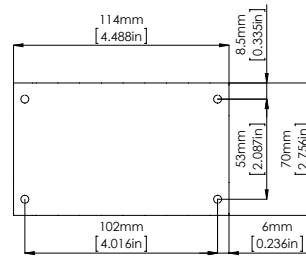

9-pole Models

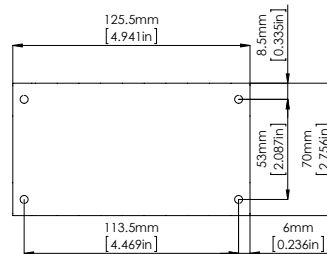

10-pole Models

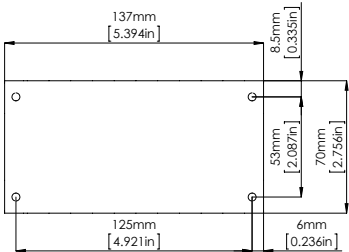

11-pole Models

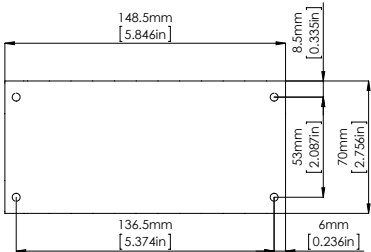

12-pole Models

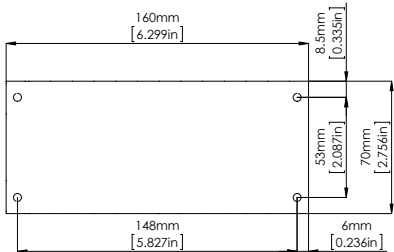

4. INSTALLATION

13-pole Models

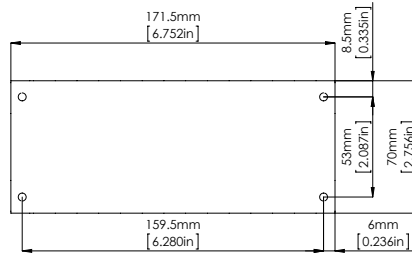

14-pole Models

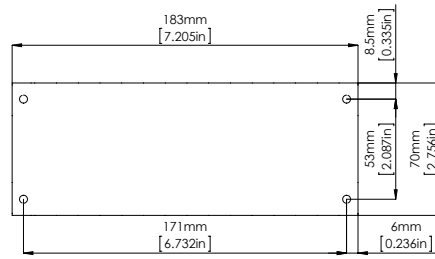

15-pole Models

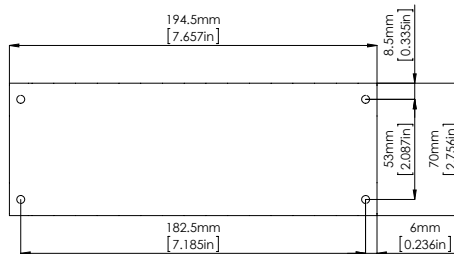

16-pole Models

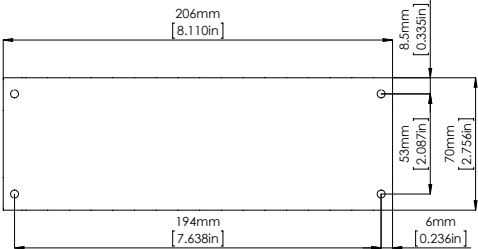

17-pole Models

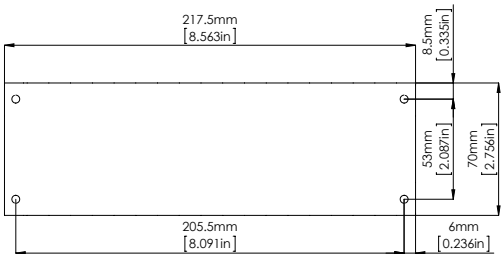

18-pole Models

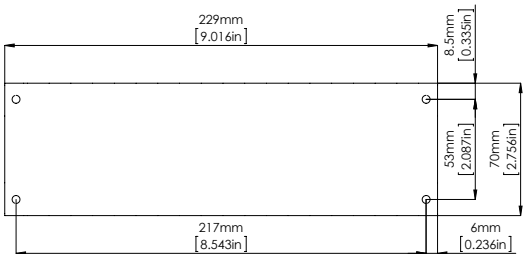

4. INSTALLATION

19-pole Models

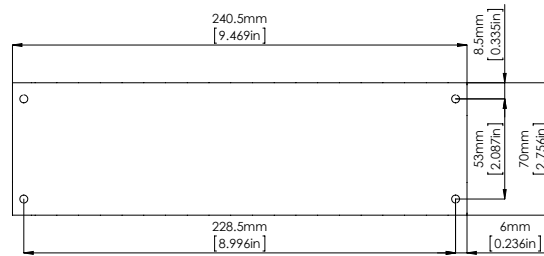

20-pole Models

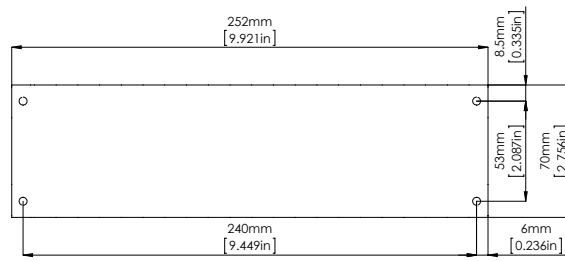

5 Operation

Handling of PAX test probes should be done using only the insulated plastic parts, since the fingers may be connected to live equipment either via the test block or test equipment.

Store the PAX test probes carefully in order to avoid damage to the metallic test fingers. **SECUCONTROL** recommends using one of the cases listed under “Accessories” on page 29.

1. Remove the SAX dust cover (if one is used, optional accessory) by unscrewing the two knurled screws that hold it, and lifting it up.
2. Connect cables from the test set with the corresponding PAX test probe.
3. Carefully align the PAX test probe with the corresponding positions on the SAX terminal / test block.
4. Insert the PAX test probe in one smooth and even movement into the SAX terminal / test block.

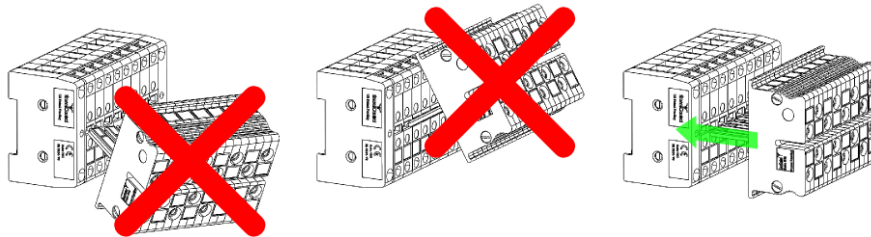

Even insertion means that the test probe should always be positioned in a line parallel to the terminal / test block while inserting - not at an angle.

There is no need to externally short-circuit the current transformers, since the PAX test probes have internal shorting bars which will automatically short circuit the corresponding circuits before opening them. Special test probes that are built for current measurement purposes do NOT automatically short-circuit current transformer circuits. These test probes carry special warning labels. They must be correctly connected to a measurement instrument before insertion into the SAX terminal / test block, and used by properly trained personnel only.



5. OPERATION

5. Finally, remove the PAX test probe in a single, even and continuous movement.
6. Reattach the dust cover (if one is used).

6 Technical Specifications

Electrical

Current Withstand	30 A continuously 500 A for 1 second
Maximum voltage	600 V
Contact resistance	$\leq 2 \text{ m}\Omega$
Dielectric Withstand	3.0 kV RMS for 1 minute between adjacent contact pairs and between any contact pair and other metal parts 2.0 kV RMS for 1 minute between open contacts when test probe is inserted
Voltage Impulse	3 positive and 3 negative impulses of 5 kV peak, 1.2/50 μs , 0.5 J between adjacent contact pairs and between all contact pairs and other metal parts
Temperature Range	-25 to +70 °C (-13 to +158°F), storage -25 to +55°C (-13 to +131°F), operation
UL94 Flammability Class	V-0
Enclosure Protection	IP20

SAX / PAX has been classified as electromagnetically benign by the Guide for the EMC Directive 2004/108/EC and is, therefore, excluded from the scope of the EMC Directive.

6. TECHNICAL SPECIFICATIONS

Mechanical

# of poles	SAX Weight		PAX Weight	
	(kg)	(lbs)	(kg)	(lbs)
1	-	-	0.05	0.11
2	-	-	0.10	0.22
3	-	-	0.14	0.31
4	0.40	0.88	0.19	0.42
5	0.47	1.04	0.23	0.51
6	0.54	1.19	0.28	0.62
7	0.61	1.34	0.33	0.72
8	0.68	1.50	0.37	0.82
9	0.75	1.65	0.42	0.92
10	0.82	1.81	0.46	1.02
11	0.89	1.96	0.51	1.12
12	0.96	2.12	0.56	1.22
13	1.03	2.27	0.60	1.32
14	1.10	2.43	0.65	1.43
15	1.17	2.58	0.69	1.53
16	1.24	2.73	0.74	1.63
17	1.31	2.89	0.79	1.73
18	1.38	3.04	0.83	1.83
19	1.45	3.20	0.88	1.93
20	1.53	3.37	0.92	2.03

Dimensional Drawings SAX

4-pole models

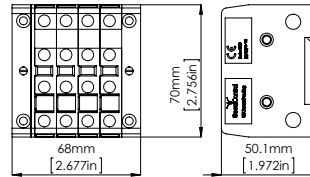

5-pole models

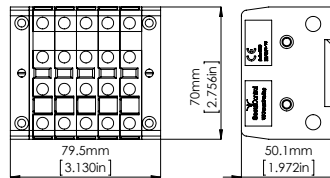

6-pole models

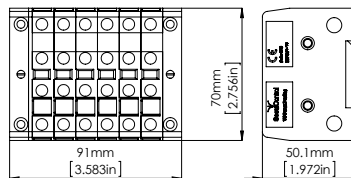

6. TECHNICAL SPECIFICATIONS

7-pole models

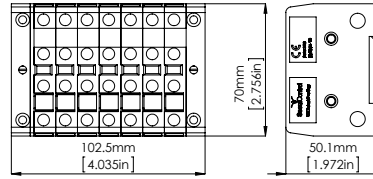

8-pole models

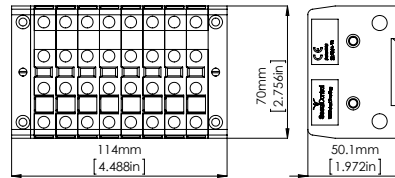

9-pole models

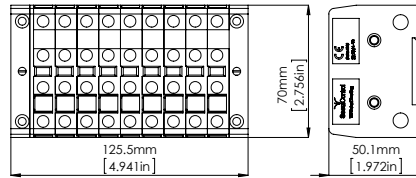

10-pole models

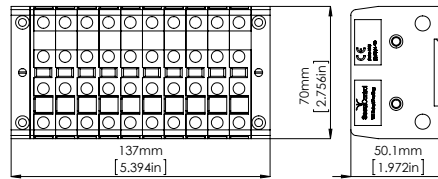

11-pole models

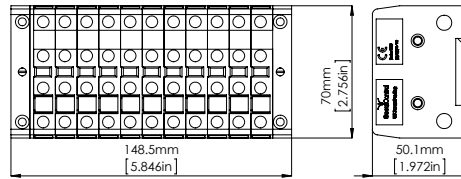

12-pole models

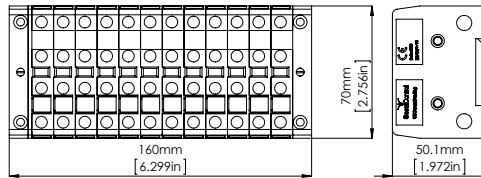

13-pole models

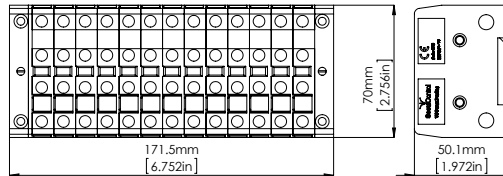

14-pole models

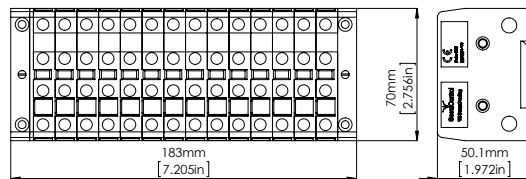

6. TECHNICAL SPECIFICATIONS

15-pole models

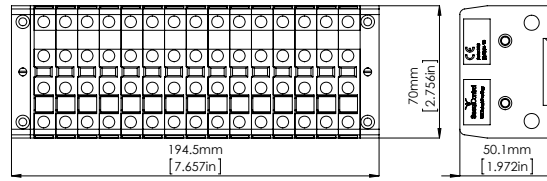

16-pole models

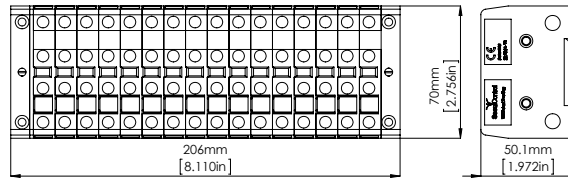

17-pole models

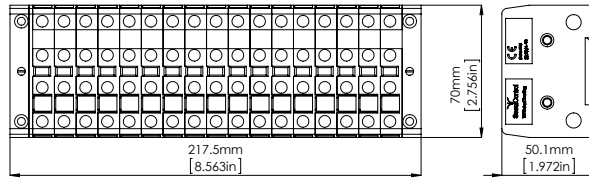

18-pole models

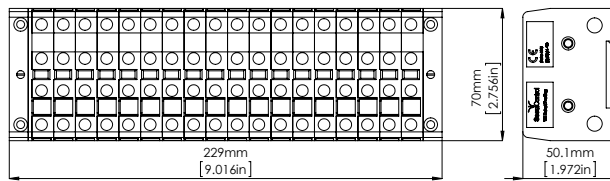

19-pole models

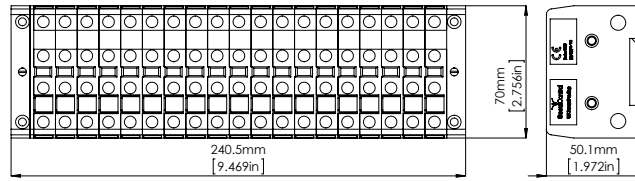

20-pole models

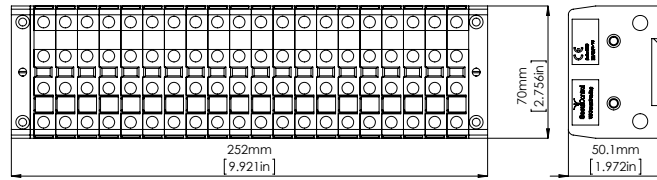

6. TECHNICAL SPECIFICATIONS

Dimensional Drawings PAX

1-pole models

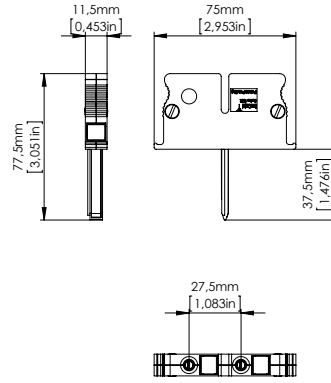

2-pole models

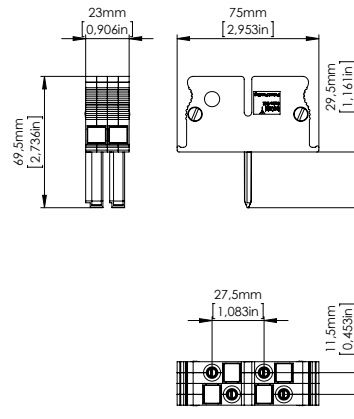

3-pole models

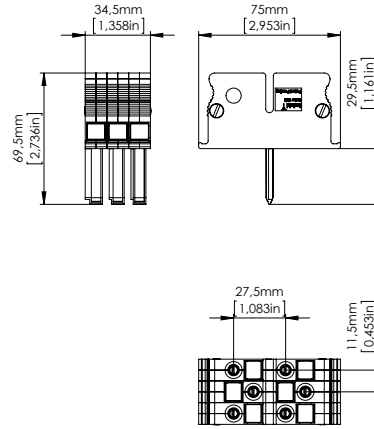

4-pole models

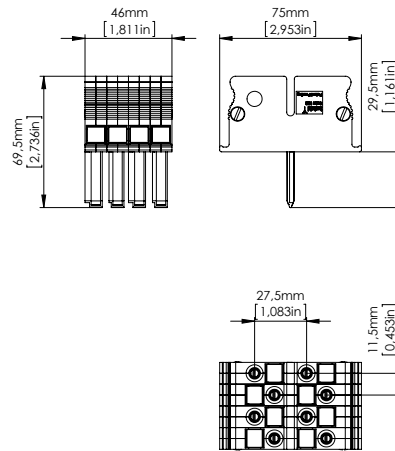

6. TECHNICAL SPECIFICATIONS

5-pole models

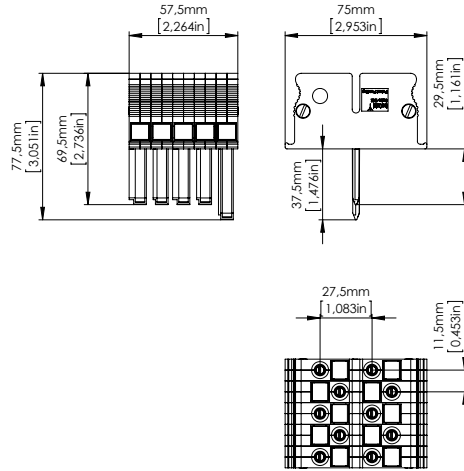

6-pole models

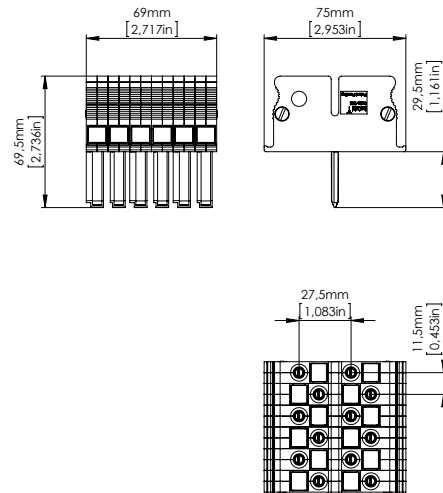

7 Accessories

Cases for PAX Test Probes

Rugged case for PAX test probes.

Description	Order Code
Case for PAX test probes	CPAX1



Test Probes Set

Set of individual test probes in a rugged case.

Description	Order Code
Universal Test Probe Set “Small”	UPAX1
Universal Test Probe Set “Large”	UPAX2



Two configurations are available:

“Small” Set

- 3 × 2-pole current probes (for single currents and return)
- 1 × 4-pole current probes (for three currents and common return)

7. ACCESSORIES

- 6 × single pole probes (for voltages, trips and signals)

“Large” Set

- 6 × 2-pole current probes (for single currents and return)
- 2 × 4-pole current probes (for three currents and common return)
- 12 × single pole probes (for voltages, trips and signals)

Disconnect Pins

Pins for electrical circuit interruption between sides “a” and “b” sides of the SAX test block. Current pins include an internal shorting bridge.

Description	Order Code
Voltage or signal pin (10 pc)	DP01RX
2-pole current pin (10 pc)	DP04WC
4-pole current pin (10 pc)	DP02WC



Current Measurement Probe

This special test probe allows the connection of current measurement device or a shunt. The AWG 13 (2.5 mm²) connection cable has a length of 118,11 inch (3 meters). The test probe are available with c-hook terminals or banana plugs at the tip of the cable.

The Current Measurement Probe is a special tool that is built for current measurement purposes. It does NOT automatically short-circuit current transformer circuits upon insertion into the SAX test block. Instead, current circuits are opened and redirected via the attached wires once the probe is entered into the test block. The probe must always be correctly connected to a measurement instrument or a shunt before insertion into the SAX test block, to prevent the creation of an open current transformer circuit. These should be used by properly trained personnel only.



Description	Order Code
C-hook connection	UTPC1
Banana plug connection	UTPC2



Dust Covers for SAX Test Blocks

Acrylic plastic cover for dust protection.

Description	Order Code
4-pole cover	SAXDC04ST
5-pole cover	SAXDC05ST
6-pole cover	SAXDC06ST
7-pole cover	SAXDC07ST
8-pole cover	SAXDC08ST
9-pole cover	SAXDC09ST
10-pole cover	SAXDC10ST
11-pole cover	SAXDC11ST
12-pole cover	SAXDC12ST
13-pole cover	SAXDC13ST
14-pole cover	SAXDC14ST
15-pole cover	SAXDC15ST
16-pole cover	SAXDC16ST
17-pole cover	SAXDC17ST
18-pole cover	SAXDC18ST
19-pole cover	SAXDC19ST
20-pole cover	SAXDC20ST

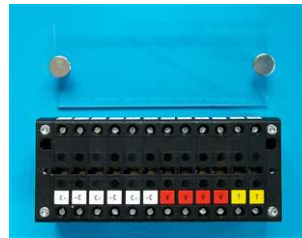

8 Spare Parts

Fitting Screws

Screws for surface mounting of the SAX test block.

Description	Order Code	Qty.
M4x50 socket cap screw	SCR450	10 pcs



9 Ordering Information

Available Configurations

A list of available Configurations can be found in the download section of our website.

Should your application require a configuration that is not listed below, please contact **SECUCONTROL** at any of the addresses listed on the rear cover of this manual, or use the configurator on our homepage.

North America

SecuControl Inc.
2873 Duke Street
Alexandria, VA 22314
USA
Tel +1 703 838 7677
mail@secucontrol.com
www.secucontrol.com

Europe

SecuControl GmbH
Ascherslebener Str. 3
D-06333 Hettstedt
Germany
Tel +49 3476 550 022
info@secucontrol.com
www.secucontrol.com

South America

SecuBrasil Ltda
Rod José Carlos Daux, 8600
88050-001 Florianópolis SC
Brazil
Tel +55 (48) 3371 1670
comercial@secubrasil.com
www.secubrasil.com