

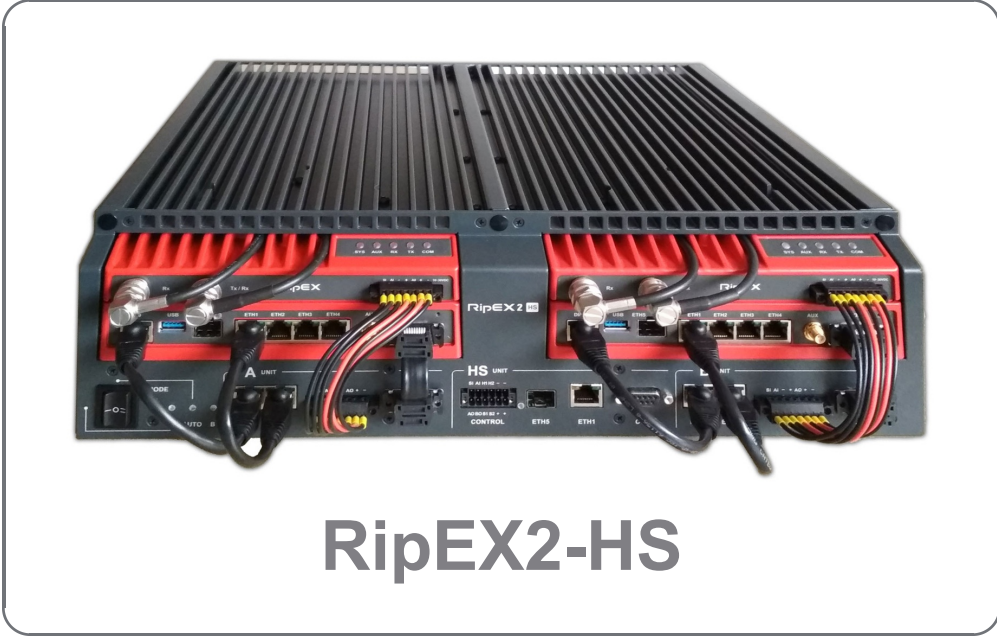



User manual



Hardware



Configuration



Parameters



version 1.4
2020-12-07
fw 1.4.7.0

Table of Contents

Important Notice	5
Getting started	6
1. RipEX2 Hot Standby	8
1.1. Introduction	8
2. RipEX2-HS in detail	9
2.1. Functionality	9
2.2. Block diagram	9
2.3. Operating modes	10
2.4. Switching over	10
2.5. HW alarms	10
3. Product	11
3.1. Dimensions	11
3.2. Front panel RipEX2-HS	14
3.3. Rear panel	17
4. Installation	19
4.1. Mounting	19
4.2. Power	19
4.3. Grounding	20
4.4. Antenna	21
5. Settings	22
6. Troubleshooting	24
7. Technical parameters	25
8. Safety, environment, licensing	27
8.1. Frequency	27
8.2. Safety distance	27
8.3. Electric power shock hazard	27
8.4. High temperature	27
8.5. RoHS and WEEE compliance	28
8.6. Conditions of Liability for Defects and Instructions for Safe Operation of Equipment	29
8.7. Important Notifications	31
8.8. Product Conformity	32
8.9. Warranty	33
A. Abbreviations	34
Revision History	35

List of Figures

1. RipEX2-HS	6
2.1. Block diagram	9
3.1. RipEX2-HS dimensions	11
3.2. RipEX2-RD dimensions	12
3.3. RipEX2-RS dimensions	13
3.4. RipEX2-HS front panel	14
3.5. HS unit	14
3.6. A unit, B unit	15
3.7. LED panel	16
3.8. RipEX2-HS/RD/RS rear panel	17
3.9. N connector	18
3.10. Power supply connector AC model	18
3.11. Power supply connector DC model	18

4.1. RipEX2-HS Rack mounted	19
4.2. RipEX2-HS/RD/RS adjustable rail	19
4.3. Locking L-holder	19
4.4. RipEX2-HS grounding in the rack	21
8.1. EU Declaration of Conformity RoHS, WEEE	29
8.2. EU Declaration of Conformity RED	32

Important Notice

Copyright

© 2020 RACOM. All rights reserved.

Products offered may contain software proprietary to RACOM s. r. o. (further referred to under the abbreviated name RACOM). The offer of supply of these products and services does not include or infer any transfer of ownership. No part of the documentation or information supplied may be divulged to any third party without the express written consent of RACOM.

Disclaimer

Although every precaution has been taken in preparing this information, RACOM assumes no liability for errors and omissions, or any damages resulting from the use of this information. This document or the equipment may be modified without notice, in the interests of improving the product.

Trademark

All trademarks and product names are the property of their respective owners.

Important Notice

- Due to the nature of wireless communications, transmission and reception of data can never be guaranteed. Data may be delayed, corrupted (i.e., have errors), or be totally lost. Significant delays or losses of data are rare when wireless devices such as the RipEX2-HS are used in an appropriate manner within a well-constructed network. RipEX2-HS should not be used in situations where failure to transmit or receive data could result in damage of any kind to the user or any other party, including but not limited to personal injury, death, or loss of property. RACOM accepts no liability for damages of any kind resulting from delays or errors in data transmitted or received using RipEX2-HS, or for the failure of RipEX2-HS to transmit or receive such data.
- Under no circumstances is RACOM or any other company or person responsible for incidental, accidental or related damage arising as a result of the use of this product. RACOM does not provide the user with any form of guarantee containing assurance of the suitability and applicability for its application.
- RACOM products are not developed, designed or tested for use in applications which may directly affect health and/or life functions of humans or animals, nor to be a component of similarly important systems, and RACOM does not provide any guarantee when company products are used in such applications.

Getting started

RipEX2-HS serves as a redundant station equipped with two standard RipEX2 radio modems using a hot standby functionality. All you have to do to put it into operation is to connect properly all connectors and configure internal RipEX2 units using a PC and a web browser.



Fig. 1: RipEX2-HS

RipEX2 access defaults: IP 192.168.169.169/24, username: admin, password: admin or IP 10.9.8.7 when accessing over the optional USB/ETH adapter or Wifi adapter.

Power on the RipEX2-HS and wait approx. for 25 seconds for the RipEX2 OS to boot. When accessing over the optional USB/ETH adapter or Wifi adapter, your PC will get its IP settings from the built-in DHCP server and you have to type <https://10.9.8.7> in your browser.

When accessing over Ethernet, set a static IP 192.168.169.x/24 on your PC first, connect your PC to RipEX2 ETH interface, start your browser and type <https://192.168.169.169> in the address line. When accessing RipEX2 for the first time and using https, you have to accept the https security certificate issued by RACOM.



Note

Both RipEX2 units are in factory default settings.

Package contents:

- RipEX2-HS chassis ... 1x
- HS controller to RipEX2 units interconnection cables ... 10x (2x power cable, 2x RS232 cable, 6x Cat5 cable)
- RipEX2-HS chassis safety lock ... 2x
- 19" rack adjustable shelf ... 2x
- 19" rack mounting screws ... 10x
- spare fuses ... 2x
- ordered separately: RipEX2 units ... 2x

Package does not contain

- AC/DC power supply cable (2 pieces needed)
- surge arresters

1. RipEX2 Hot Standby

1.1. Introduction

RipEX2-HS is designed to be used on critical sites, where high stress on HW reliability is required – typically master or repeater stations. It is hot standby, 1+1 redundant, fully monitored, hot swappable equipment.

RipEX2-HS is assembled with 2 standard RipEX2 units, each powered by its independent power supply. Controller takes care of the automatic changeover in case of failure. Changeover conditions are widely configurable. Since both units are hot standby and use identical MAC addresses addresses on ETH interface, an, an exceptional switch-over time of less than 2 s is reached.

LED panel, Mode switch, HW alarm outputs, SNMP traps and standard RipEX2 units inside make RipEX2-HS configuration and control quite easy and maintenance can be done by anyone familiar with RipEX2.

2. RipEX2-HS in detail

2.1. Functionality

There are two standard RipEX2 units with identical configurations inside RipEX2-HS. Both units are booted, however only one is active. Some interfaces (COM, ETH1 and Radio) of the non-active unit are disconnected.



Note

Even if Rx on inactive RipEX2 unit LED panel is blinking when the active unit is transmitting, these packets are not received. I.e. they don't take part in Statistic, Neighbours or Graphs.

When the active unit HW alarm output changes to "On" (e.g. when a controlled value exceeds the respective threshold), the controller automatically switches interfaces (COM, ETH1, ANT—if applicable) to the second unit and it takes over all functions. Since both units are using the same MAC addresses (MAC cloning), there is a minimal drop-out while switching, less than 2 s.

When RipEX2 units inside RipEX2-HS are in Bridge mode, the first switch-over takes approx. 30 s. It is because hot standby RipEX2 ARP table is clear and has to be filled with first packets (forward delay). The next switch-over takes less than 2 s. When Operating mode is Router, even the first switch-over takes less than 2 s. When ARP proxy in Router mode is used, switch-over time(s) is equal to that of the Bridge mode.

2.2. Block diagram

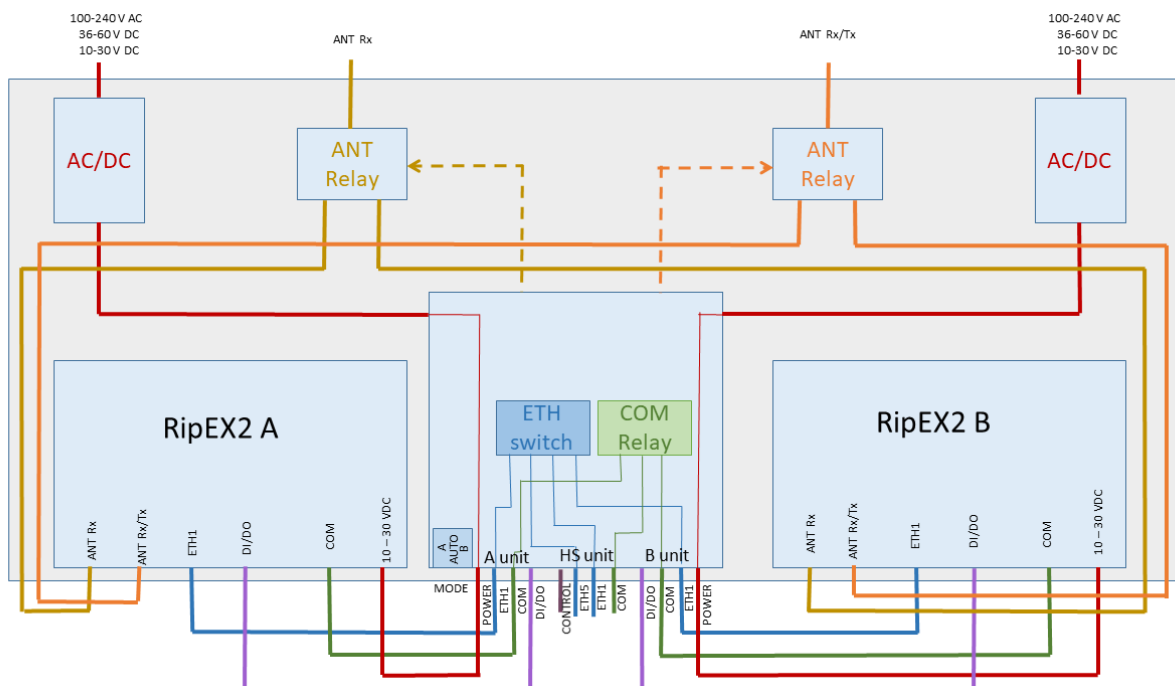

Fig. 2.1: Block diagram

2.3. Operating modes

- **Auto** – primary active is RipEX2 “A”, when it fails, controller automatically switches-over to RipEX2 “B”. When both units are with alarms, “A” unit remains active.
- **A** – only RipEX2 “A” is active and controller will never switch to RipEX2 “B”
- **B** – only RipEX2 “B” is active and controller will never switch to RipEX2 “A”

A and **B** modes are supposed to be used only for the maintenance/testing and not for normal service.

2.4. Switching over

In order to achieve maximum reliability, the controller is software free. Switching-over is based only on HW alarm outputs of RipEX2 units and the HW signals from their power supplies.

The HW alarm of active RipEX2 or its power supply will cause the immediate and unconditional switch-over to hot standby RipEX2. If there are any packets waiting in queues of RipEX2 which becomes inactive, these packets are discarded after switch-over.

2.4.1. Power alarm

Power supply of respective unit is “Off” when the input voltage from the respective power supply to the controller is out of voltage working range.

Some borderline examples for Auto mode (Primary unit is always “A”. The second unit is standby):

1. Power alarm of Primary unit is “On”
- Standby unit becomes active
2. Primary unit alarm is “On” and Power alarm of Standby is “On” or Standby unit alarm is “On”
- Nothing will be done. Primary unit remains active
3. Primary unit alarm is “On”, it was switched to Standby unit, Primary unit alarm disappeared
- it will be switched back to Primary unit immediately (the protective timeout of 30 s will be held for shorter HW alarm output changes)

2.5. HW alarms

In order to achieve maximum reliability, the controller is software free. Switch-over is based only on HW alarm outputs of RipEX2 units and their power supplies.

Switch-over is based on HW alarm outputs of RipEX2 units, their power supplies and detector of radio Tx and antenna degradation.

3. Product

3.1. Dimensions

3.1.1. RipEX2-HS

19" rack 3U, H × W × D: 120 × 442 × 392 mm (4.72 × 17.40 × 15.43 inch.)

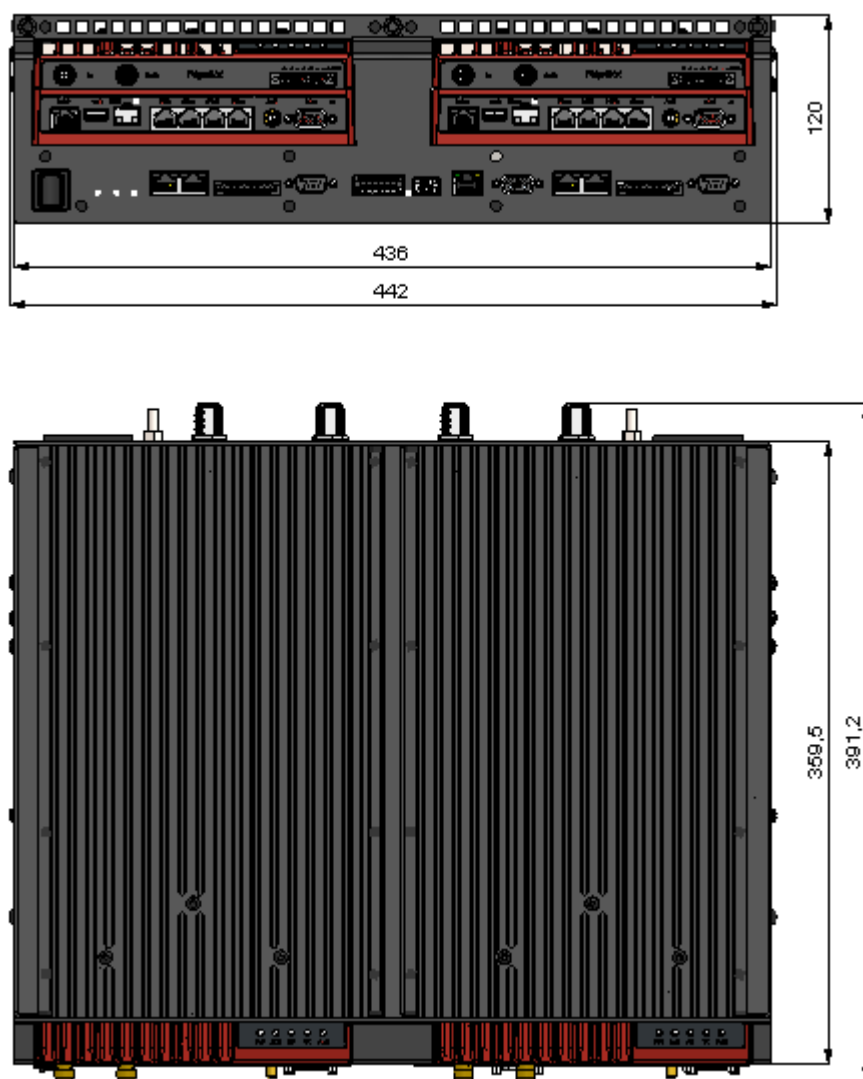

Fig. 3.1: RipEX2-HS dimensions

3.1.2. RipEX2-RD

19" rack 3U, H × W × D: 87 × 442 × 392 mm (3.42 × 17.40 × 15.43 inch.)

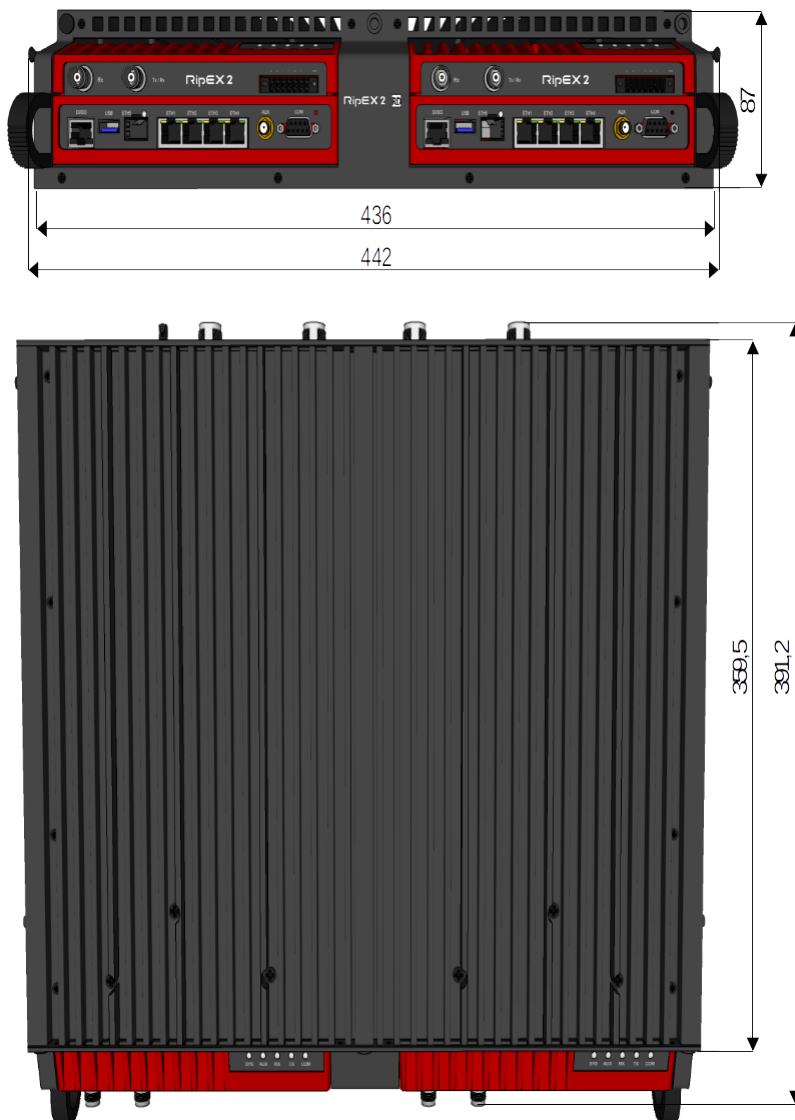

Fig. 3.2: RipEX2-RD dimensions

3.1.3. RipEX2-RS

19" rack 3U, H × W × D: 87 × 442 × 392 mm (3.42 × 17.40 × 15.43 inch.)

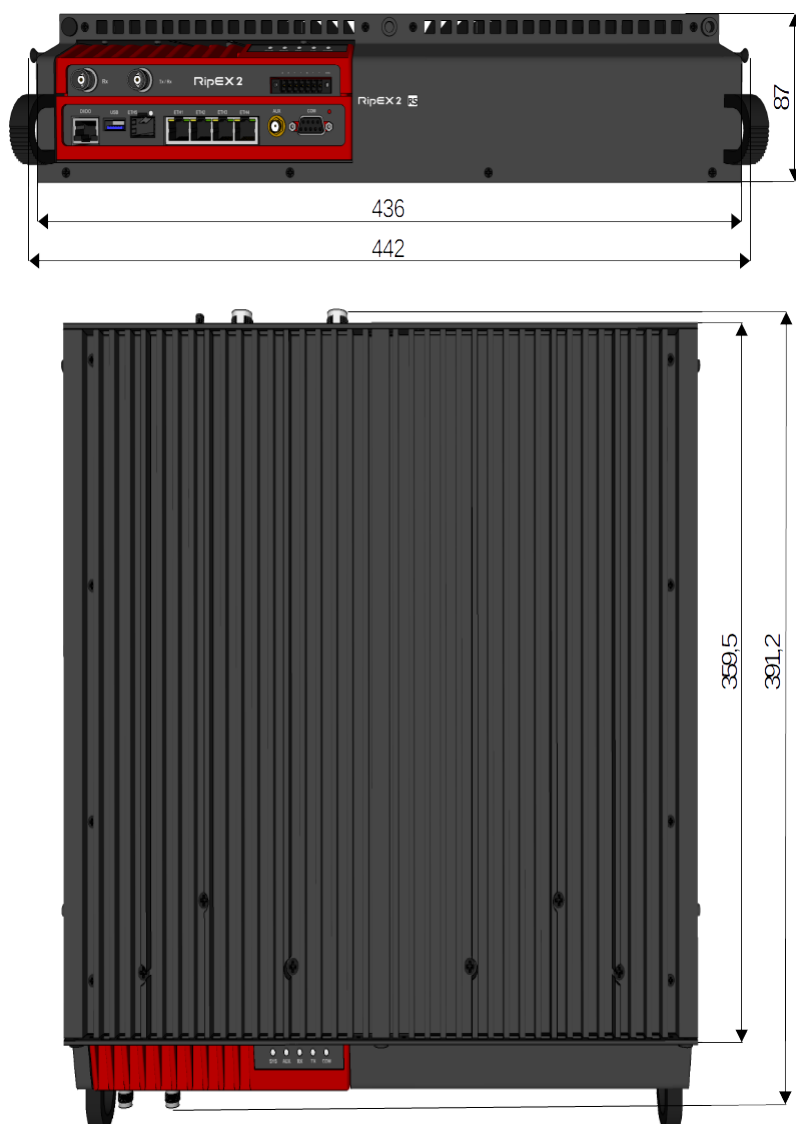

Fig. 3.3: RipEX2-RS dimensions

3.2. Front panel RipEX2-HS

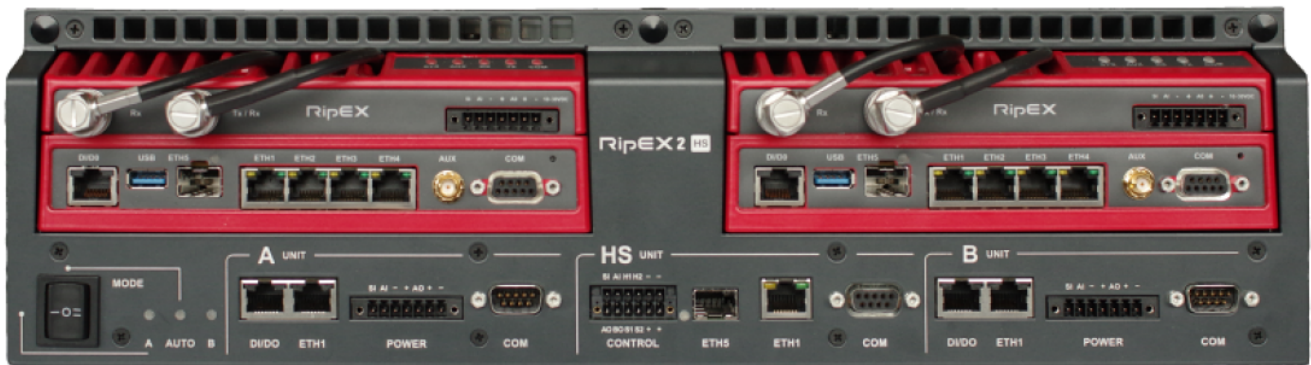

Fig. 3.4: RipEX2-HS front panel

3.2.1. Connectors available on front panel

All connectors for RipEX2 units are described in RipEX2 User manual (*Chap. 1.2*)

Connectors of the RipEX2-HS are splitted to three sections: HS unit, "A" unit and "B" unit.

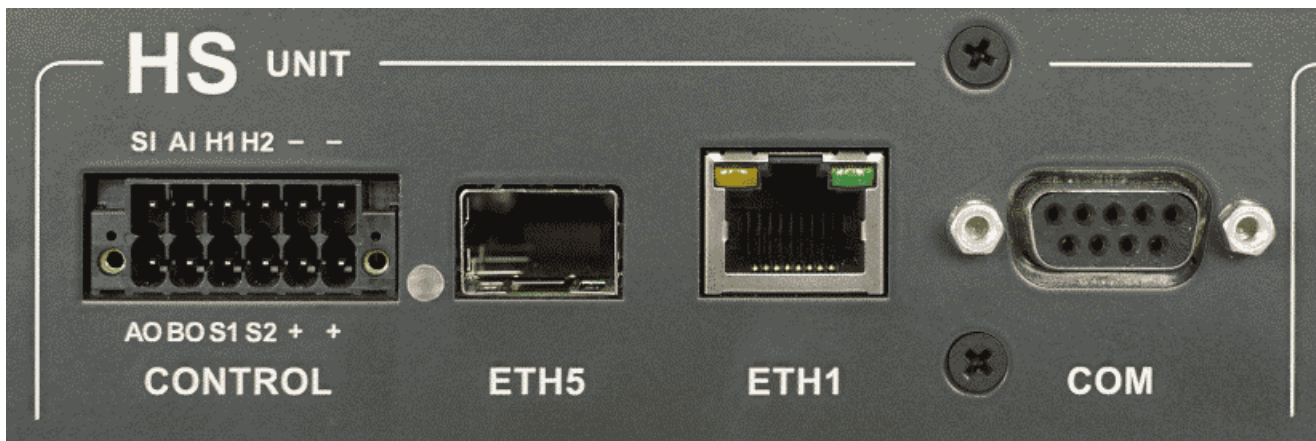

Fig. 3.5: HS unit

Connectors of this sections serves as connection with external equipment.

Description of each connector is the same as with RipEX2 unit and you can find it in RipEX2 manual.

ETH1 and ETH5 (SFP) are connected to an internal switch, for connection of both ETH to the individual RipEX2, units the ETH1 connector in A unit and B unit section shall be used.

12 pin connector (Type of plug Phoenix Contact 1790331)

Pin description	
SI Sleep input	This input is connected to the SI pin on power connector of the active RipEX2 unit
AI Alarm input	This input is connected to the AI pin on power connector of the active RipEX2 unit
H1	Allows HW driven switching between active units in AUTO mode

Pin description	
H2	Allows HW driven switching between active units in AUTO mode
AO	Alarm output of the "A" unit RipEX2
BO	Alarm output of the "B" unit RipEX2
S1	Alarm status output – indication of an alarm of HS controller
S2	Alarm status output – indication of an alarm of "A" unit or/and "B" unit



Fig. 3.6: A unit, B unit

Connectors of this section has to be interconnected with respective connectors of appropriate RipEX2 unit.

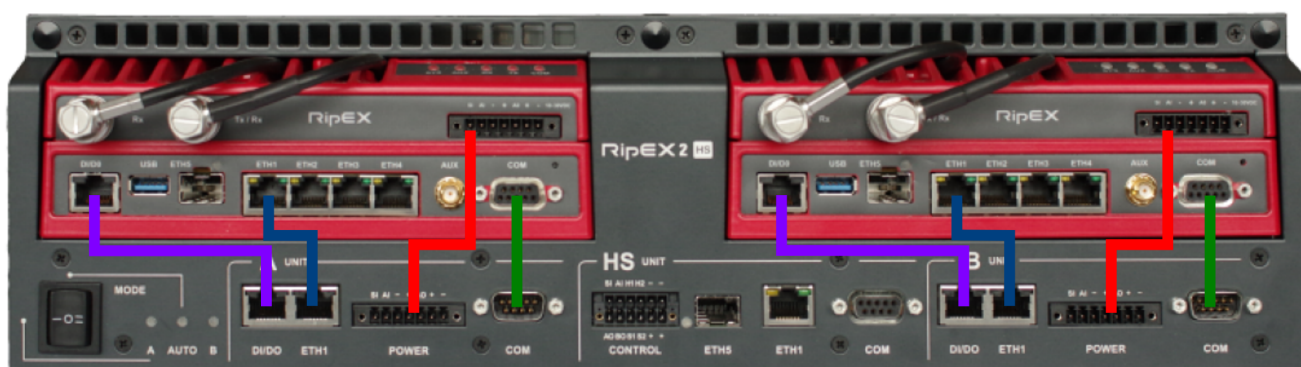

3.2.2. LED panels description

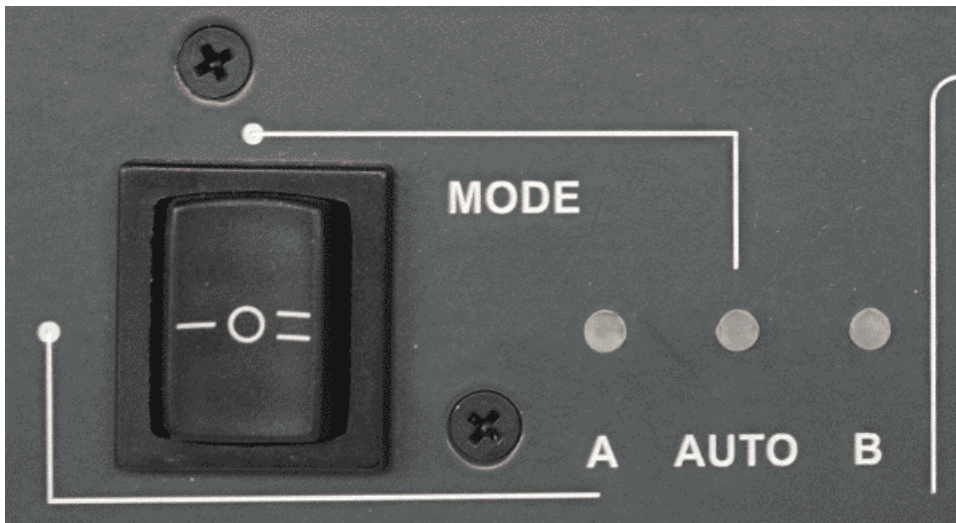

Fig. 3.7: LED panel

Tab. 3.1: LED panel description

	Symbol	Description
1	AUTO	<p>Dark mode AUTO is not active</p> <p>Green solid – ready, both RipEX2 units powered and no alarm known</p> <p>red solid – alarm status, when only this LED is red indicates alarm of the controller, otherwise together with unit in alarm status dark – RipEX2 "A" is not active</p>
2	A	<p>Green solid – Unit "A" active - selected as active by switch</p> <p>green blinking – AUTO mode ready to serve</p> <p>Red solid – unit in alarm status</p> <p>Red blinking – power supply alarm (together with red solid AUTO LED)</p>
3	B	<p>Green solid – active - selected as active by switch</p> <p>Green blinking – AUTO mode ready to serve</p> <p>Red solid – unit in alarm status</p> <p>Red blinking – power supply alarm (together with red solid AUTO LED)</p>

Tab. 3.2: MODE selector

MODE	Description
A	RipEX2 unit "A" hard selected – it remains active even in case of alarm on unit "A"
AUTO	AUTO mode – A unit active till an alarm status on "A" unit occurs, which causes switching to unit "B".
B	RipEX2 unit "B" hard selected – it remains active even in case of alarm on unit "B"

For more details see *Chapter 2, RipEX2-HS in detail*.



Note

When testing the changeover, please wait at least 30 seconds between individual tests.

3.3. Rear panel

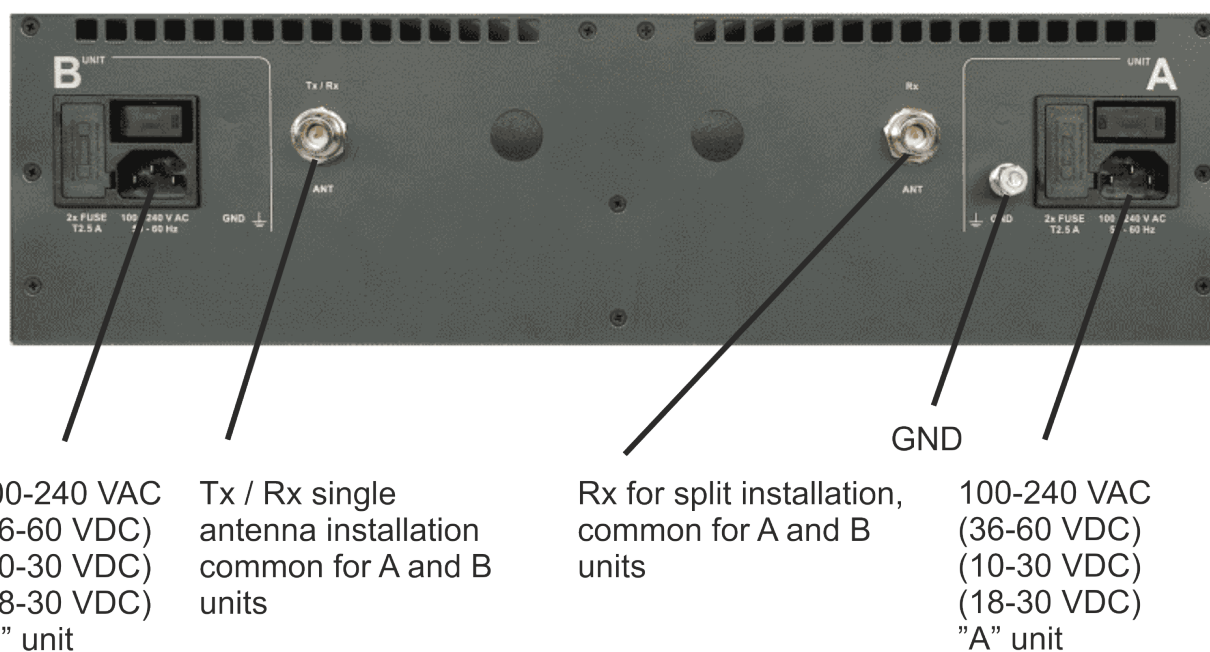

Fig. 3.8: RipEX2-HS/RD/RS rear panel

3.3.1. Common connectors

Antenna

There are different models in terms of antenna connectors. N-female connector is always used.



Fig. 3.9: N connector

3.3.2. A and B connectors

Power supply connector AC model

100–240 V AC equipped with T2.5A fuse

Optionally 36-60 V DC, 18-30 V DC or 10-30 V DC



Fig. 3.10: Power supply connector AC model

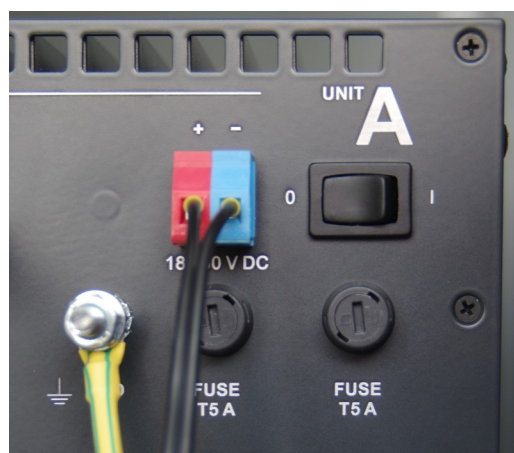

Fig. 3.11: Power supply connector DC model

4. Installation

4.1. Mounting

RipEX2-HS is delivered by default with adjustable rail, which can be adjusted for different 19" Rack depths in range of 380-610mm.



Fig. 4.1: RipEX2-HS Rack mounted

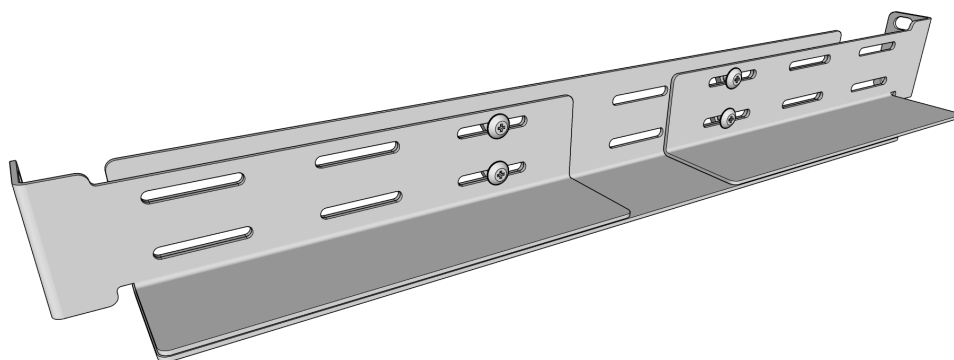

Fig. 4.2: RipEX2-HS/RD/RS adjustable rail



Note

Pull-out holders (placed on both sides of the chassis) servers only for pulling the RipEX2-HS out of the shelf, not for carrying.



Fig. 4.3: Locking L-holder

4.2. Power

Power supply according to the HW variant of RipEX2-HS see <https://www.racom.eu/eng/products/ripex-hot-standby.html#features>¹

¹ <https://www.racom.eu/eng/products/ripex-hot-standby.html#order-codes>

4.2.1. 100–240 V AC, 50–60 Hz

Since there are two independent power supplies, one for each RipEX2 unit, it is recommended to connect each power supply to a separate power phase with individual circuit breakers. When one phase would be off, RipEX2-HS will still be On.

There are individual power connectors for each power supply. See *Section 3.3, “Rear panel”*.

4.2.2. 36–60 V DC

There are also two independent power supplies with 36 to 60 V DC input voltage, one for each RipEX2 unit; input conductors are isolated from the rest of the RipEX2-HS and thus allows positive or negative grounding. The electric strength is 4 kV AC / 1 min.



Note

When positive grounding is used, neither device connected via RS232, USB, ETH can have negative grounding!

There are individual power connectors for each power supply. See *Section 3.3, “Rear panel”*

4.2.3. 10–30 V DC

There is not any internal power supply in this option, powering is the same as for standard RipEX2.

The supply must be capable of providing the required input for the projected RF output. The power supply must be sufficiently stable so that voltage does not drop when switching from receive to transmit, which takes less than 1.5 ms. To avoid radio channel interference, power supply must meet all relevant EMC standards. Never install a power supply close to the antenna. Maximal supply cable length is 3 m, and recommended wire cross section 1.0 mm².

4.2.4. 18–30 V DC

There are also two independent power supplies with 18 to 30 V DC input voltage, one for each RipEX2 unit; input conductors are isolated from the rest of the RipEX-HS and thus allows positive or negative grounding. The electric strength is 4 kV AC / 1 min.

When positive grounding is used, neither device connected via RS232, USB, ETH can have negative grounding! There are individual power connectors for each power supply. See *section 3.3, “Rear panel”*

4.3. Grounding

The grounding screw on the rear panel has to be properly connected to the grounding point of the rack. The minimal required copper conductor cross-section is 4 mm².

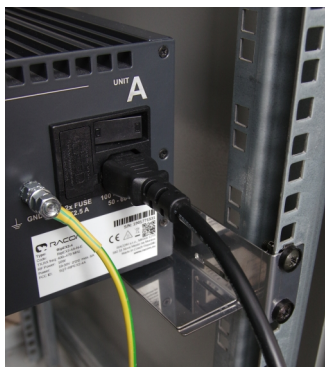

Fig. 4.4: RipEX2-HS grounding in the rack

4.4. Antenna

For antenna installation refer to *RipEX User manual*².

² <https://www.racom.eu/eng/products/m/ripex/instal.html#antenna-mount>

5. Settings

Only the controller version of the RipEX2-HS is supported, where the controller manages the active and passive/standby RipEX2 units and their accessing to the shared channels (e.g. radio).

The communication between individual RipEX2 units and HS controller use DI/DO interfaces, so other use of this interface is not possible.

The HW switch (mode selector) has to be set to AUTO position for switching between units, otherwise the selected unit remains active even if an error occurs on the selected one.

AUTO regime allows switching to the standby unit when an error status occur in active unit – if both units are without alarms, the A unit will be active.

Menu ADVANCED/Device/Unit menu/Hot Standby

The screenshot shows the 'Hot standby' configuration page. On the left, there is a navigation menu with 'Unit' selected. The main content area has tabs for 'General', 'Service USB', 'Time', and 'Hot standby'. The 'Hot standby' tab is active, showing the following settings:

- Hot standby mode:** Enabled (checked)
- Virtual MAC:** 00:00:5E:00:01:1F
- Virtual IP:** 10.128.1.10
- Unit chassis position:** Unit A
- Fallback time [s]:** 20
- Guard mode:** INCLUDE
- Guarded interfaces:**
 - Guard ETH1 active:
 - Guard ETH2 active:
 - Guard ETH3 active:
 - Guard ETH4 active:
 - Guard ETH5 active:
- Guard 'Radio TX or Antenna degraded' active:**
- Actions:** Toggle now

- **Hot standby mode enabled**

Listbox {On, Off } default Off
Switches Hot Standby functionality.

- **Virtual MAC**

MAC address of shared LAN interface. It should be same for both individual RipEX2 units. This MAC address has to differ from other MAC addresses used in unit. It is possible to use e.g. VRRP type of addresses: 00:00:5E:00:01:XX.

- **Virtual IP**

This address has to fit into range of addresses used for the relevant network interface (e.g. ETH 1) and will be used as shared IP address for LAN interface. The radio address use used according to setting in SETTINGS/Interfaces/Radio/IP - the same address has to be set in both radio modems.

- **Unit chassis position**

Listbox {Unit A, Unit B} default Unit B
Position of the unit in HS chassis, set Unit A for unit in A position and vice versa.

- **Fallback time**

Time in seconds. The time delay to stay on the standby unit, after all alarms are solved.

- **Guard mode**

Listbox {INCLUDE, EXCLUDE} default INCLUDE
Defines the behavior of guarding of ETH interfaces. INCLUDE requires all guarded lines in UP status – if one of these guarded lines is not in UP state, alarm occurs and the switching to the standby unit is executed.

- **Guard ETH1 .. ETH5 active**

Listbox {On, Off} default Off

Switches on guarding of the individual ETH link.

- **Toggle now**

This button allows to switch from unit Active status to the non-active.

It will not be possible if:

- The second unit is in alarm status.
- The HW MODE selector is not set to AUTO.
- The unit is in not-active status.



Note

It is possible to change the active status from the A to the B unit using shall command **“rrcmd rrhstdby web passivate”** and back from A to B using command **“rrcmd rrhstdby web activate”**. Both units should be without errors for the SW sw itching.

- **Setting of LAN interface**

It is necessary to set LAN interface used for HS functionality.

Menu ADVANCED/Interfaces/Ethernet/Subnets

The parameter Range for virtual address has to be set to On for the LAN address interconnected with shared ETH interface (Range for virtual address set to On).



Note

Interconnected ETH interface IP addresses of both ETH addresses should be different as well as addresses of A and B units, yet in the same range as the virtual shared address (= together three different addresses in the same range).

6. Troubleshooting

To troubleshoot RipEX2 units, please refer to RipEX2 User Manual Chap. 9. Troubleshooting

1. The switch-over works, but the ETH connection starts working with some delay
 - Check if MAC addresses are really identical for both active and inactive units
2. Automatic switch-over does not take place:
 - Make sure that A or B mode is not used, AUTO mode has to be used.

7. Technical parameters

Tab. 7.1: Technical parameters

Radio parameters		
The same as RipEX2 units used		
Electrical		
Primary power	HW models:	100–240 V AC, 50–60 Hz
		36–60 V DC, positive grounding possible
		10–30 V DC
		18-30 V DC, positive grounding possible
Individual power supply for each RipEX2 unit		
Interfaces		
Ethernet	1× 10/100 Base-T Auto MDI/MDIX switched with 1× 10/100/1000 Base-T 1000Base-SX/1000 Base-LX	1x RJ45, 1x SFP
COM	RS232/RS485 SW configurable 300–115 200 bps	DB9F
Antenna	50 Ω	N-female(s)
	HW models (according to Antenna)	
	2× N-female – separate Tx / Rx and Rx, switched	
	4× N-female – separate Rx and Tx, separate for each RipEX2 unit	
HW inputs, HW outputs	"A" unit alarm, "B" unit alarm, HS controller alarm, "A" and/or "B" alarm	
Environmental		
IP Code (Ingress Protection)	IP40	
MTBF	> 900 000 (> 100 years)	
Operating temperature	- 40 to +70 °C (-40 to +158 °F)	
Humidity	5 to 95 % non-condensing	
Storage	-40 to +85 °C (-40 to +185 °F) 5 to 95 % non-condensing	
Mechanical		
Dimensions HS	19" rack 3U H × W × D: 120 × 442 × 392 mm (4.72 × 17.40 × 15.43 in)	
Dimensions RD	19" rack 2U H × W × D: 87 × 442 × 392 mm (3.42 × 17.40 × 15.43 in)	
Dimensions RS	19" rack 2U H × W × D: 87 × 442 × 392 mm (3.42 × 17.40 × 15.43 in)	
Weight HS	8.9 kg (19.6 lbs), RipEX2 units excl.	
	12.1 kg (26.7), RipEX2 units incl.	
Weight RD		
Weight RS		
Diagnostic and Management		

Standard for individual RipEX2 units used	
LED panels	For each RipEX2 unit: standard RipEX2 LED panel (5× tri-color LEDs: SYS, AUX, RX, TX, COM) + 3× two-color LEDs: (A, AUTO, B) + 1x ETH5(SFP)
Approvals	
CE	RED, RoHS, WEEE

8. Safety, environment, licensing

8.1. Frequency

The radio modem must be operated only in accordance with the valid frequency license issued by national frequency authority and all radio parameters have to be set exactly as listed.



Important

Use of frequencies between 406.0 and 406.1 MHz is worldwide-allocated only for International Satellite Search and Rescue System. These frequencies are used for distress beacons and are incessantly monitored by the ground and satellite Cospas-Sarsat system. Other use of these frequencies is forbidden.

8.2. Safety distance



Safety distances with respect to the US health limits of the electromagnetic field intensity are in Minimum Safety Distance tables below, calculated for different antennas and RipEX2 power levels. The distances were calculated according to the health limits and apply to far-field region only. Whenever the result is comparable or smaller than the actual size of the respective antenna, the field intensity is even smaller than the far-field based calculation and the safety limit is never exceeded. For output power 0.2 W or lower the safety limit is not exceeded at any distance and any of the antennas.

Tab. 8.1: Worst case Minimum Safety Distance

	Antenna Gain		
	5 dBi	10 dBi	15 dBi
160 MHz	2 m	3 m	5 m
300 and 400 MHz	2 m	2 m	4 m

For detailed Minimum Safety Distances refer to *RipEX User Manual*¹.

8.3. Electric power shock hazard



BEFORE uncovering the RipEX2-HS be sure that the power plug is disconnected. It is not allowed to use the RipEX2-HS without the cover because of the risk of electric power shock!

8.4. High temperature



When changing the RipEX2 units in an environment where the ambient temperature exceeds 55 °C, prevent human contact with the enclosure heatsink of the RipEX2 units.

¹ https://www.racom.eu/eng/products/m/ripex/safety.html#safety_dist

8.5. RoHS and WEEE compliance

RoHS
compliant

WEEE
compliant

This product is fully compliant with the European Parliament's 2011/65/EU RoHS (Restriction of Certain Hazardous Substances in Electrical and Electronic Equipment) and 2012/19/EU WEEE (Waste Electrical and Electronic Equipment) environmental directives.



Used equipment must be collected separately, and disposed of properly. RACOM has instigated a programme to manage the reuse, recycling, and recovery of waste in an environmentally safe manner using processes that comply with the WEEE Directive.

Battery Disposal - This product may contain a battery. Batteries must be disposed of properly, and may not be disposed of as unsorted municipal waste within the European Union. See the product documentation for specific battery information. Batteries are marked with a symbol, which may include lettering to indicate cadmium (Cd), lead (Pb), or mercury (Hg). For proper recycling, return the battery to your supplier or to a designated collection point.



Fig. 8.1: EU Declaration of Conformity RoHS, WEEE

8.6. Conditions of Liability for Defects and Instructions for Safe Operation of Equipment

Please read these safety instructions carefully before using the product:

- Liability for defects does not apply to any product that has been used in a manner which conflicts with the instructions contained in this operator manual, or if the case in which the radio modem is located has been opened, or if the equipment has been tampered with.
- The radio equipment can only be operated on frequencies stipulated by the body authorised by the radio operation administration in the respective country and cannot exceed the maximum permitted output power. RACOM is not responsible for products used in an unauthorised way.
- Equipment mentioned in this operator manual may only be used in accordance with instructions contained in this manual. Error-free and safe operation of this equipment is only guaranteed if this equipment is transported, stored, operated and controlled in the proper manner. The same applies to equipment maintenance.
- In order to prevent damage to the radio modem and other terminal equipment the supply must always be disconnected upon connecting or disconnecting the cable to the radio modem data interface. It is necessary to ensure that connected equipment has been grounded to the same potential.
- Only undermentioned manufacturer is entitled to repair any devices.

8.7. Important Notifications

Sole owner of all rights to this operating manual is the company RACOM s. r. o. (further in this manual referred to under the abbreviated name RACOM). All rights reserved. Drawing written, printed or reproduced copies of this manual or records on various media or translation of any part of this manual to foreign languages (without written consent of the rights owner) is prohibited.

RACOM reserves the right to make changes in the technical specification or in this product function or to terminate production of this product or to terminate its service support without previous written notification of customers.

Conditions of use of this product software abide by the license mentioned below. The program spread by this license has been freed with the purpose to be useful, but without any specific guarantee. The author or another company or person is not responsible for secondary, accidental or related damages resulting from application of this product under any circumstances.

The maker does not provide the user with any kind of guarantee containing assurance of suitability and usability for his application. Products are not developed, designed nor tested for utilization in devices directly affecting health and life functions of persons and animals, nor as a part of another important device, and no guarantees apply if the company product has been used in these aforementioned devices.

8.8. Product Conformity

The image shows a document titled "EU DECLARATION OF CONFORMITY" for RACOM. It includes the RACOM logo and website, a table of technical details, a statement of responsibility, a list of harmonized standards, and a signature block.

RACOM
www.racom.eu

EU DECLARATION OF CONFORMITY

Radio equipment type	Redundant hot standby chassis RipEX2-HS	suitable for RipEX2-4 units
Manufacturer	RACOM s.r.o. Mirova 1283, 592 31 Nove Mesto na Morave, Czech Republic	

This declaration of conformity is issued under the sole responsibility of the manufacturer.

The radio equipment described above is in conformity with the Directive 2014/53/EU of the European Parliament and of the Council on the harmonisation of the laws of the Member States relating to the making available on the market of radio equipment and repealing Directive 1999/5/EC.

Harmonised standards used for demonstration of conformity:

Spectrum	According to RipEX2-4 unit EU DoC
EMC	EN 301 489-1 V2.1.1 EN 301 489-4 V3.1.1
Safety	EN 62368-1:2014 + A11:2017
SAR	According to RipEX2-4 unit EU DoC

Signed for and on behalf of the manufacturer:

Nove Mesto na Morave, 22nd of May 2019
Jiri Hruska, CEO

Jiri Hruska

RACOM s.r.o. | Mirova 1283 | 592 31 Nove Mesto na Morave | Czech Republic
Tel.: +420 722 937 522 | E-mail: racom@racom.eu

www.racom.eu

ver. 1.0

Fig. 8.2: EU Declaration of Conformity RED

8.9. Warranty

RACOM-supplied parts or equipment ("equipment") is covered by warranty for inherently faulty parts and workmanship for a warranty period as stated in the delivery documentation from the date of dispatch to the customer. The warranty does not cover custom modifications to software. During the warranty period RACOM shall, on its option, fit, repair or replace ("service") faulty equipment, always provided that malfunction has occurred during normal use, not due to improper use, whether deliberate or accidental, such as attempted repair or modification by any unauthorised person; nor due to the action of abnormal or extreme environmental conditions such as overvoltage, liquid immersion or lightning strike.

Any equipment subject to repair under warranty must be returned by prepaid freight to RACOM direct. The serviced equipment shall be returned by RACOM to the customer by prepaid freight. If circumstances do not permit the equipment to be returned to RACOM, then the customer is liable and agrees to reimburse RACOM for expenses incurred by RACOM during servicing the equipment on site. When equipment does not qualify for servicing under warranty, RACOM shall charge the customer and be reimbursed for costs incurred for parts and labour at prevailing rates.

This warranty agreement represents the full extent of the warranty cover provided by RACOM to the customer, as an agreement freely entered into by both parties.

RACOM warrants the equipment to function as described, without guaranteeing it as befitting customer intent or purpose. Under no circumstances shall RACOM's liability extend beyond the above, nor shall RACOM, its principals, servants or agents be liable for any consequential loss or damage caused directly or indirectly through the use, misuse, function or malfunction of the equipment, always subject to such statutory protection as may explicitly and unavoidably apply hereto.

Appendix A. Abbreviations

CLI	Command Line Interface	OS	Operation System
CTS	Clear To Send	PC	Personal Computer
DCE	Data Communication Equipment	PER	Packet Error Rate
DQ	Data Quality	PWR	Power
DTE	Data Terminal Equipment	RF	Radio Frequency
EMC	Electro-Magnetic Compatibility	RipEX	Radio IP Exchanger
FCC	Federal Communications Commission	RoHS	Restriction of the use of Hazardous Substances
FEP	Front End Processor	RSS	Received Signal Strength
GPL	General Public License	RTS	Request To Send
https	Hypertext Transfer Protocol Secure	RTU	Remote Terminal Unit
IP	Internet Protocol	RX	Receiver
kbps	kilobit per second	SCADA	Supervisory control and data acquisition
LAN	Local Area Network	SDR	Software Defined Radio
MAC	Media Access Control	SNMP	Simple Network Management Protocol
MDIX	Medium dependent interface crossover	TCP	Transmission Control Protocol
MIB	Management Information Base	TX	Transmitter
NMS	Network Management System	UDP	User Datagram Protocol
N.C.	Normally Closed	VSWR	Voltage Standing Wave Ratio
N.O.	Normally Open	WEEE	Waste Electrical and Electronic Equipment

Revision History

Revision

This manual was prepared to cover a specific version of firmware code. Accordingly, some screens and features may differ from the actual unit you are working with. While every reasonable effort has been made to ensure the accuracy of this publication, product improvements may also result in minor differences between the manual and the product shipped to you.

Revision 1.0 First issue	2019-01-03
Revision 1.1 Minor improvements	2019-09-06
Revision 1.2 Minor modifications	2019-11-25
Revision 1.3 Section Mounting modified	2020-02-28
Revision 1.4 FW 1.4.7.0 functionalities added	2020-12-03