



USER GUIDE

NSE 3000

System Release 1.1



Reservation of Rights

Cambium reserves the right to make changes to any products described herein to improve reliability, function, or design, and reserves the right to revise this document and to make changes from time to time in content hereof with no obligation to notify any person of revisions or changes. Cambium recommends reviewing the Cambium Networks website for the latest changes and updates to products. Cambium does not assume any liability arising out of the application or use of any product, software, or circuit described herein; neither does it convey license under its patent rights or the rights of others. It is possible that this publication may contain references to, or information about Cambium products (machines and programs), programming, or services that are not announced in your country. Such references or information must not be construed to mean that Cambium intends to announce such Cambium products, programming, or services in your country.

Copyrights

This document, Cambium products, and 3rd Party software products described in this document may include or describe copyrighted Cambium and other 3rd Party supplied computer programs stored in semiconductor memories or other media. Laws in the United States and other countries preserve for Cambium, its licensors, and other 3rd Party supplied software certain exclusive rights for copyrighted material, including the exclusive right to copy, reproduce in any form, distribute and make derivative works of the copyrighted material. Accordingly, any copyrighted material of Cambium, its licensors, or the 3rd Party software supplied material contained in the Cambium products described in this document may not be copied, reproduced, reverse engineered, distributed, merged or modified in any manner without the express written permission of Cambium. Furthermore, the purchase of Cambium products shall not be deemed to grant either directly or by implication, estoppel, or otherwise, any license under the copyrights, patents or patent applications of Cambium or other 3rd Party supplied software, except for the normal non-exclusive, royalty free license to use that arises by operation of law in the sale of a product.

Restrictions

Software and documentation are copyrighted materials. Making unauthorized copies is prohibited by law. No part of the software or documentation may be reproduced, transmitted, transcribed, stored in a retrieval system, or translated into any language or computer language, in any form or by any means, without prior written permission of Cambium.

License Agreements

The software described in this document is the property of Cambium and its licensors. It is furnished by express license agreement only and may be used only in accordance with the terms of such an agreement.

High Risk Materials

Cambium and its supplier(s) specifically disclaim any express or implied warranty of fitness for any high-risk activities or uses of its products including, but not limited to, the operation of nuclear facilities, aircraft navigation or aircraft communication systems, air traffic control, life support, or weapons systems ("High Risk Use").

This product is not restricted in the EU. Any High Risk is unauthorized, is made at your own risk and you shall be responsible for any and all losses, damage or claims arising out of any High-Risk Use.

Contents

Contents	3
About This Guide	5
Purpose	5
Cross references	5
Feedback	5
Warnings, cautions, and notes	5
Warnings	5
Cautions	5
Notes	6
Problems and warranty	6
Reporting problems	6
Repair and service	6
Hardware warranty	6
Security advice	6
Caring for the environment	7
In EU countries	7
In non-EU countries	7
Basic information about the products	8
Hardware information	8
Prerequisite tasks	9
Install rubber feet	9
Power supply	11
LED status	11
Managing NSE 3000 using cnMaestro	12
Advanced onboarding setup	13
Configure the management PC	13
Logging into the UI	13
NSE 3000 Dashboard	15

UI Controls	15
Viewing the dashboard	16
WAN Configuration	17
Operation	20
Firmware upgrade	20
System	21
Configuration	22
Troubleshoot	23
Connectivity	23
Logs	27
Glossary	29
Cambium Networks	31

About This Guide

This document explains how to configure the NSE 3000 products. It is intended for use by the system designer, system installer, and system administrator.

Purpose

Documents specific to the NSE 3000 products are intended to instruct and assist personnel in the operation, installation, and maintenance of the NSE 3000 device (Cambium Networks) and ancillary devices of NSE 3000 products. It is recommended that all personnel engaged in such activities must be properly trained.

Cambium Networks disclaims all liability, whatsoever, implied or express - for any risk of damage, loss or reduction in system performance arising directly or indirectly out of the failure of the customer, or anyone acting on the customer's behalf - to abide by the instructions, system parameters, or recommendations made in this document.

Cross references

References to external publications are shown in italics. Other cross references, emphasized in blue text in electronic versions, are active links to the references.

This document is divided into topics that are divided into sections. Sections are not numbered and are listed in the table of contents.

Feedback

We appreciate feedback from the users of our documents. This includes feedback on the structure, content, accuracy, or completeness of our documents. To provide feedback, visit our support website - <https://support.cambiumnetworks.com>.

Warnings, cautions, and notes

The following sections describe how warnings, notes, and cautions are used in this document and in all documents of Cambium Networks:

Warnings

Warnings precede instructions that contain potentially hazardous situations. Warnings are used to alert the reader to possible hazards that could cause loss of life or physical injury. A warning has the following format:



Warning

Warning text and consequence for not following the instructions in the warning.

Cautions

Cautions precede instructions and are used when there is a possibility of damage to systems, software, or individual items of equipment within a system. However, this damage presents no danger to personnel. A caution has the following format:



Caution

Caution text and consequence for not following the instructions in the caution.

Notes

A note means that there is a possibility of an undesirable situation or provides additional information to help the reader understand a topic or concept. A note has the following format:



Note

Note text.

Problems and warranty

Reporting problems

If any problems are encountered when installing or operating this equipment, follow this procedure to investigate and report:

1. Search this document and the software release notes of supported releases.
2. Visit the [support website](#) (Cambium Networks).
3. Ask for assistance from the Cambium Networks product supplier.
4. Gather information from affected units, such as any available diagnostic downloads.
5. Escalate the problem by emailing or telephoning support.

Repair and service

If unit failure is suspected, obtain details of the Return Material Authorization (RMA) process from the [support website](#).

Hardware warranty

Cambium's standard hardware warranty is for one (1) year from the date of shipment from Cambium Networks or a Cambium distributor. Cambium Networks warrants that hardware will conform to the relevant published specifications and will be free from material defects in material and workmanship under normal use and service. Cambium shall within this time, at its own option, either repair or replace the defective product within thirty (30) days of receipt of the defective product. Repaired or replaced products will be subject to the original warranty period but not less than thirty (30) days.



Caution

Using non-Cambium parts for repair could damage the equipment or void warranty. Contact Cambium for service and repair instructions.

Portions of Cambium equipment may be damaged from exposure to electrostatic discharge. Use precautions to prevent damage.

Security advice

Cambium Networks systems and equipment provide security parameters that can be configured by the operator based on their particular operating environment. Cambium Networks recommends setting and using these parameters following industry recognized security practices. Security aspects to be considered are protecting the confidentiality, integrity, and availability of information and assets. Assets

include the ability to communicate, information about the nature of the communications, and information about the parties involved.

In certain instances Cambium Networks makes specific recommendations regarding security practices, however the implementation of these recommendations and final responsibility for the security of the system lies with the operator of the system.

Caring for the environment

The following information describes national or regional requirements for the disposal of Cambium Networks supplied equipment and for the approved disposal of surplus packaging.

In EU countries

The following information is provided to enable regulatory compliance with the European Union (EU) directives identified and any amendments made to these directives when using Cambium Networks equipment in EU countries.

Disposal of Cambium equipment

European Union (EU) Directive 2012/19/EU Waste Electrical and Electronic Equipment (WEEE).

Do not dispose the Cambium Networks equipment at landfill sites. For disposal instructions, refer to <https://www.cambiumnetworks.com/support/compliance/>.

Disposal of surplus packaging

Do not dispose the surplus packaging in landfill sites. In the EU, it is the individual recipient's responsibility to ensure that packaging materials are collected and recycled according to the requirements of EU environmental law.

In non-EU countries

In non-EU countries, dispose of Cambium equipment and all surplus packaging in accordance with national and regional regulations.

Basic information about the products

This section provides basic information about the NSE 3000 products and prerequisite tasks. This information helps you to set up the system before proceeding with the configuration of NSE 3000.

This section covers the following topics:

- [Hardware information](#)
- [Safety precautions](#)
- [Regulatory compliance](#)
- [Prerequisite tasks](#)

The Network Service Edge (NSE) product delivers advanced security, routing, and SD-WAN policies for small and medium enterprises.

NSE 3000 is the first product offering in the NSE series. It has two WAN ports and four LAN ports, and supports reliable connectivity with WAN throughputs of up to 1 Gbps. It also supports an industry-leading IDS/IPS engine, advanced application, geo-IP firewalls, network security scanners, anti-malware protection, SD-WAN, and cutting-edge application visibility and control.

Figure 1: NSE 3000 device

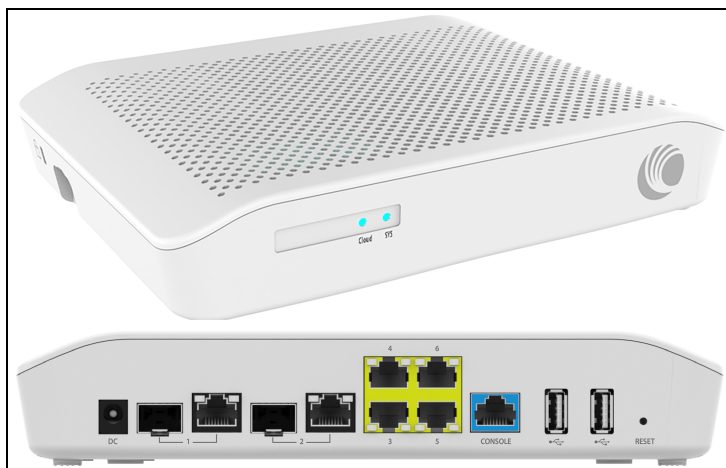

Hardware information

Table 1 NSE 3000 includes the following hardware platforms:

Table 1: Hardware information

Hardware specification	Hardware platform
WAN Ports	2 x 1 Gbps RJ45/SFP
LAN Ports	4 x 1 Gbps RJ45
Dimensions	175.16 mm x 232.72 mm x 43 mm

Hardware specification	Hardware platform
Weight	0.65 kg
Max Power consumption	22.8W
Power Supply	40W DC
Operating temperature	0°C-40°C
Operating humidity	10%-90%

Prerequisite tasks

Before performing the configuration tasks, ensure that you have met the following hardware requirements (for example):

- A personal computer (PC) or laptop if you want to connect directly to the NSE 3000 device web UI.
- NSE 3000 device with IP address configured.

To put the whole system together, you must perform the following prerequisite tasks:

1. [Install rubber feet](#)
2. [Power supply](#)
3. [LED status](#)

These prerequisite tasks help you to ensure that each component of the system is working before the final integration.

Install rubber feet

This section describes how to install rubber feet on rubber slots of the NSE 3000 device. Following two types of rubber feet are used for installation:

- [Plugin type](#)
- [Adhesive type](#)

Figure 2: Types of rubber feet

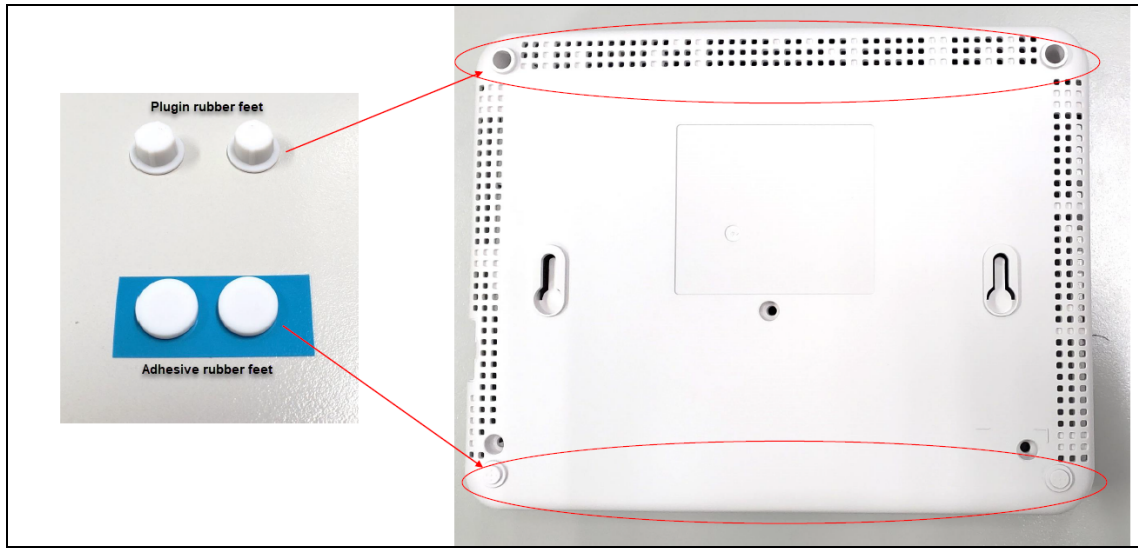

To install the rubber feet, perform the following steps:

Plugin type

1. Place the plugin rubber feet on the rubber slots.
2. Press the plugin rubber feet as shown in [Figure 3](#).

Figure 3: Placing the Plugin rubber feet type



Adhesive type

1. Peel the adhesive rubber feet from the sticker.
2. Place the adhesive rubber feet on the rubber slots.
3. Press the adhesive rubber feet as shown in [Figure 4](#).

Figure 4: Placing the adhesive rubber feet type

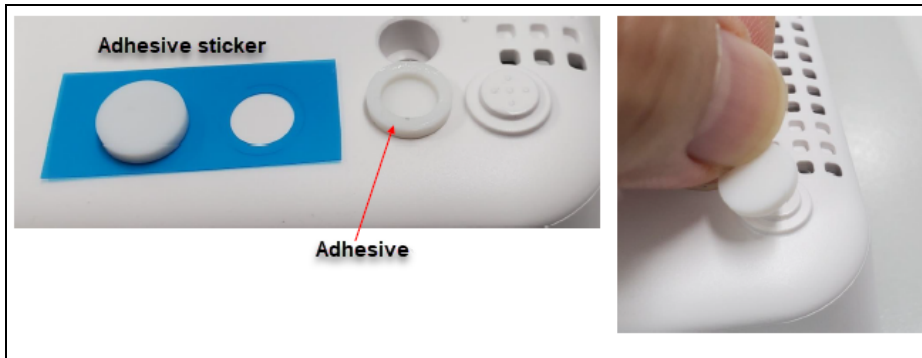

Power supply

Connect the AC power cords of the power supply to a power inlet and connect the DC plug to the DC jack of the NSE 3000 device.

LED status

LED status of the device displays as shown below:

- When NSE 3000 is booting up, the system LED is amber in color.
- When NSE 3000 is fully up and running, the system LED is green in color.

Figure 5: NSE 3000 LED

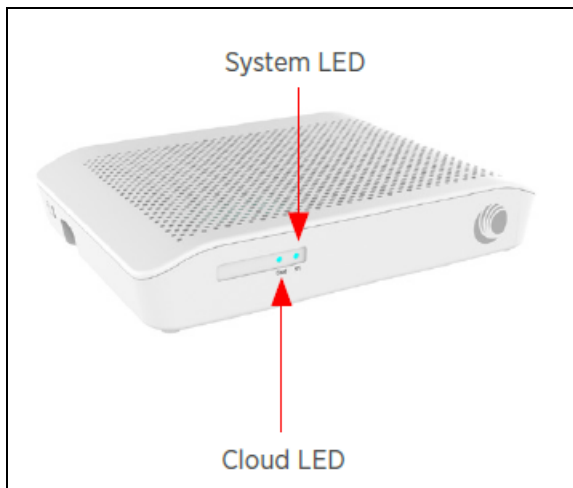

Managing NSE 3000 using cnMaestro

NSE 3000 is completely managed by the easy-to-use, secure, and cloud-hosted Cambium Networks cnMaestro Management system. A single-pane-of-glass management to operate and manage all Cambium Networks enterprise products NSE 3000 devices, Enterprise Wi-Fi, and cnMatrix switches.

To manage the NSE 3000 device through cnMaestro, refer to [cnMaestro Cloud User Guide](#).

Advanced onboarding setup

If the device has trouble in connecting to the internet or cnMaestro, you can onboard the device through device UI. For more information, refer to [Logging into the UI](#).

This section covers the following:

- [Configure the management PC](#)
- [Logging into the UI](#)
- [NSE 3000 Dashboard](#)
- [WAN Configuration](#)
- [Operation](#)
- [Troubleshoot](#)

Configure the management PC

To configure the management PC perform the following steps:

1. Ensure that the Ethernet port on the management PC is configured to use DHCP.
2. Connect the Ethernet port on the management PC to any of the LAN ports.
3. Verify that the management PC obtains an IP address in the 192.168.200.0/24 subnet. Use the `ipconfig` or `ifconfig` command to verify the IP address.

Figure 6: Device Port

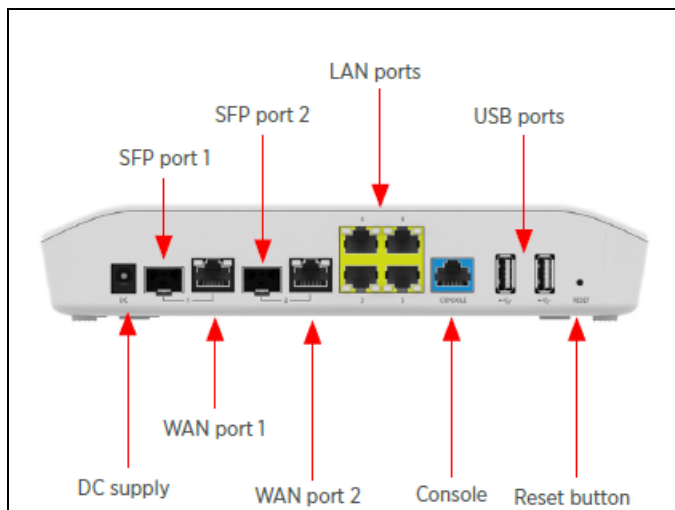

Logging into the UI

To access the NSE 3000 using the web UI, perform the following steps:



Note

New user needs to onboard the NSE 3000 device to cnMaestro, refer to [cnMaestro Cloud User Guide](#).

1. Use the default IP address (http://192.168.200.1) to connect to the NSE 3000 setup.
2. Ensure that your PC is set up to communicate with the required range of IP addresses.
3. Open a web browser and type the URL - http://192.168.200.1 - to access the NSE 3000 UI.

The **Sign In** page appears, as shown in [Figure 7](#).

[Figure 7: Sign In](#)

Sign In
NSE 3000 - NSE-7003B8
NSE3000

User Name

Password

Sign In

4. Type an appropriate username and password.

Default username: admin

Default password: admin

5. Click **Sign In**.

The NSE 3000 dashboard page appears, as shown in [Figure 8](#).

Figure 8: The NSE 3000 Dashboard

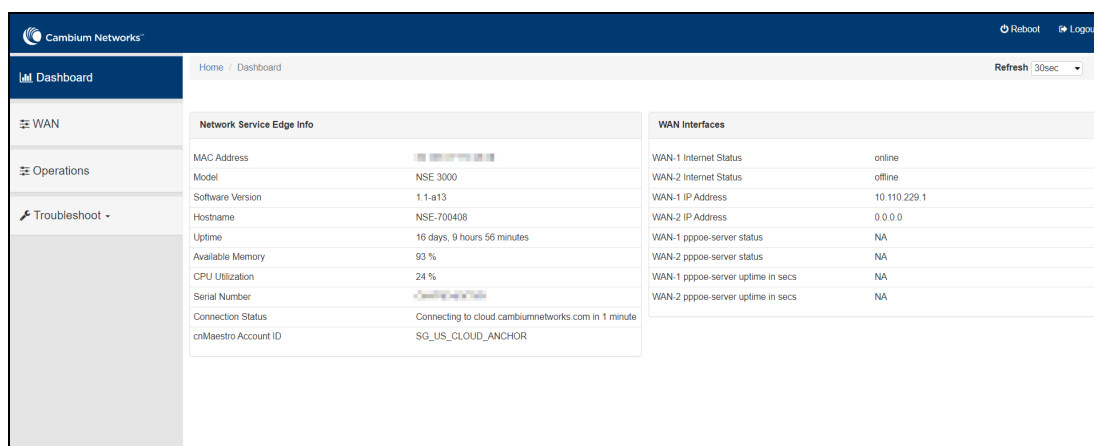

For more information about the NSE 3000 dashboard page, refer to the [Viewing the dashboard](#).

NSE 3000 Dashboard

This section provides information about UI controls and the main NSE 3000 dashboard page.







This section covers the following topics:

- [UI Controls](#)
- [Viewing the dashboard](#)

UI Controls

Before configuring the UI of NSE 3000, familiarize yourself with the UI controls (as described in [Table 2](#)). These UI controls are required for adding, viewing, and managing NSE 3000 configurations.

Table 2: List of UI controls

UI Control	UI Control name	Description
	Tools	To update firmware and reboot the unit.
	Copyright	To view the copyright information of the product.
Other common UI controls:		
	Expand	To expand the parameters of a section.
	Collapse	To collapse the parameters of a section.
	Table	To view the parameters in a column format.
	Reboot	To reboot the system from the UI.
	Logout	To logout the system from the UI.

Viewing the dashboard

On logging into the NSE 3000 device UI, the main dashboard page, appears as shown in [Figure 9](#). The below figure shows the elements that are displayed on the NSE 3000 Home page.

Figure 9: The NSE 3000 Dashboard

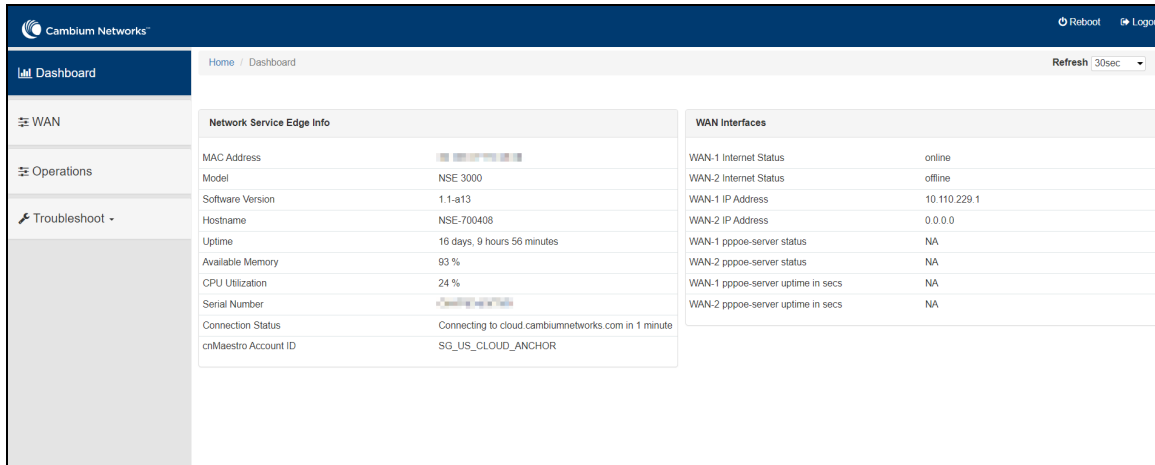

Table 3 provides the details of the parameters on the main dashboard.

Table 3: Dashboard parameters

Parameters	Description
Network Service Edge Info	
MAC Address	Media Access Control (MAC) address. The hardware address that the factory assigns to the module for identification in the Data Link layer interface of the Open Systems Interconnection system. This address serves as an electronic serial number.
Model	Provides information related to the NSE 3000 model number and configured hostname.
Software Version	Provides the information about the software version used by the NSE 3000 device.
Hostname	The unique identifier that serves as name of your computer or server can be as long as 255 characters and consists of numbers and letters.
Uptime	Time period (in seconds) at which the last successful registration of the NSE 3000 device.
Available Memory	Provides the information about the available memory of CPU.
CPU Utilization	This field indicates the current CPU utilization of the device.
Serial Number	Serial number of the device that is used for device identification.
Connection Status	This field indicates the device connectivity.

Parameters	Description
cnMaestro Account ID	This field shows Account ID which is registered with Cambium Networks and it allows operator to manage devices using cnMaestro.
WAN Interfaces	
WAN-1 Internet Status	Indicates the WAN-1 Internet status.
WAN-2 Internet Status	Indicates the WAN-2 Internet status.
WAN-1 IP Address	WAN-1 IP address that is assigned to the network interface and used for the device management.
WAN-2 IP Address	WAN-2 IP address that is assigned to the network interface and used for the device management.

WAN

The **WAN** parameters, for each end-user requirements and type of wireless station in the WAN page. For more information about the **WAN** configuration, refer to the [WAN Configuration](#) section.

Operation

The **Operation** page allows users to perform maintenance tasks of the NSE 3000 devices:

- **Firmware update:** To upgrade of the NSE 3000 devices.
- **System:** To provide different methods of debugging field issues and recovering devices.
- **Configuration:** To configure NSE 3000 device settings.

For more information about the parameters on the **Operation page**, refer to the [Operation](#) section.

Troubleshoot

The **Troubleshoot** page provides users to debug and troubleshoot the system remotely. The Troubleshoot page contains multiple sections, as listed below:

- **Connectivity:** Provides different modes of network reachability for the NSE 3000 device.
- **Logs:** Supports the feasibility to check logs for different modules of NSE 3000 devices. These logs help the customer to debug an issue.

For more information about the parameters on the **Troubleshoot** page, refer to the [Troubleshoot](#) section.

WAN Configuration

The **WAN** page allows the user to configure the device's IP address based on the IP mode.

To view and configure the WAN settings, perform the following steps:

1. From the main NSE 3000 dashboard page, navigate to **WAN** page.

The **WAN** page appears, as shown in [Figure 10](#).



Note
By default, WAN-1 page is displayed. You can configure WAN on WAN-1 or WAN-2.

Figure 10: *The WAN page*

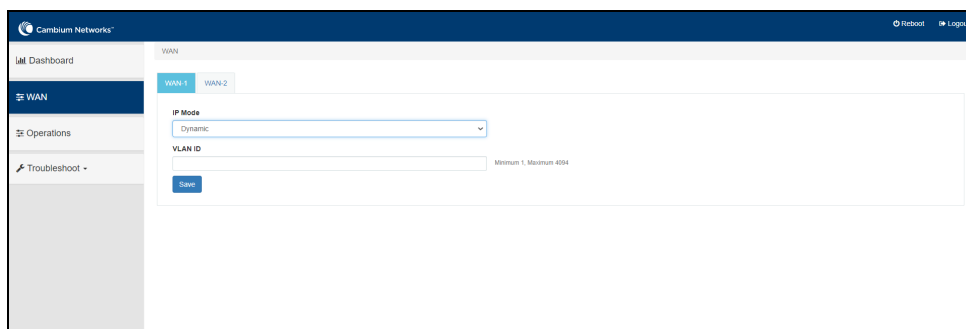

2. Set the values for each parameter, as described in [Table 4](#).

Table 4: WAN configuration parameters

Parameters	Description
IP Mode	Determines the network that must be configured to use IPv4 addresses. The following IP modes are supported: <ul style="list-style-type: none"> • Dynamic • Static • PPPoE
VLAN ID	VLANs are identified by a VLAN ID (a number between 1 - 4094), VLAN configuration is optional. When configured 802.1q header is added to all transmitted frames and received frames are expected to include 802.1q header with the same VLAN ID.
Following parameters appear only when you select the mode as Static in the IP Mode , as shown in Figure 11 .	
IP Address	Specify the 32-bit binary number that identifies a network element by both network and host.
Subnet Mask	Specify the subnet mask for the destination IP/network for this route.
Gateway	Specify the gateway for the destination IP/network for this route.
DNS	
Primary DNS	Configure the IP address of primary upstream DNS server on this Interface.

Parameters	Description
Secondary DNS	Configure the IP address of secondary upstream DNS server on this Interface.
Following parameters appear only when you select the mode as PPPoE in the IP Mode , as shown in Figure 12 .	
Account Name	Configure name of the Access Concentrator (max 32 characters). Account Name configuration is optional.
Service Name	Configure Service name (max 32 characters). Service name configuration is optional. Service name is used to identify a service with the Access Concentrator. Examples of Service name can be a ISP name or a class or quality of service.
User Name	Configure User Name for PPPoE authentication. User Name configuration is mandatory.
Password	Configure password for PPPoE authentication. Password is optional field.
MTU	Configure MTU for PPPoE Interface. MTU ranges from 500-1492 bytes. Default is 1492 bytes.
TCP MSS Clamping	Enable or Disable TCP MSS Clamping.

Figure 11: Static Mode

The screenshot displays the WAN configuration page in the Cambium Networks web interface. The page is titled 'WAN' and has tabs for 'WAN-1' and 'WAN-2'. The 'IP Mode' is set to 'Static'. The configuration fields include:

- IP Mode:** A dropdown menu currently showing 'Static'.
- IP Address:** A text input field.
- Subnet Mask:** A text input field.
- Gateway:** A text input field.
- DNS:** A section containing two text input fields for 'Primary DNS' and 'Secondary DNS'.
- VLAN ID:** A text input field with a note below it stating 'Minimum 1, Maximum 4094'.

A 'Save' button is located at the bottom left of the configuration area. The interface also features a sidebar with 'Dashboard', 'WAN', 'Operations', and 'Troubleshoot' options, and a top navigation bar with 'Reboot' and 'Logout' links.

Figure 12: PPPoE Mode

The screenshot shows the WAN configuration interface for PPPoE mode. The left sidebar contains navigation options: Dashboard, WAN (selected), Operations, Troubleshoot, Connectivity, and Logs. The main content area is titled 'WAN' and has two tabs: 'WAN-1' (active) and 'WAN-2'. The configuration fields are as follows:

- IP Mode:** A dropdown menu set to 'PPPoE'.
- Account Name:** A text input field with a note: 'Configure Account name (max 32 characters)'.
- Service Name:** A text input field with a note: 'Configure Service name (max 32 characters)'.
- User Name:** A text input field.
- Password:** A text input field.
- MTU:** A text input field containing '1492' with a note: 'Configure MTU for PPPoE (500-1492 bytes)'.
- TCP MSS Clamping:** A checkbox labeled 'Enable/Disable TCP MSS Clamping', which is currently unchecked.
- VLAN ID:** A text input field with a note: 'Minimum 1, Maximum 4094'.

A blue 'Save' button is located at the bottom left of the configuration area.

3. Click **Save**.

Operation

This section provides an overview of administrative functionalities for NSE 3000 device such as:

- [Firmware upgrade](#)
- [System](#)
- [Configuration](#)

Firmware upgrade

The running software on the NSE 3000 device can be upgraded to newer firmware. When upgrading from the UI, the user can upload the firmware file from the browser. The same process can be followed to downgrade the device to a previous firmware version if required. Configuration is maintained across the firmware upgrade process.

1. From the main NSE 3000 dashboard page, navigate to the **Operation** page > **Firmware update** section.

The **Operation** page appears, as shown in [Figure 13](#).

Figure 13: Firmware update section

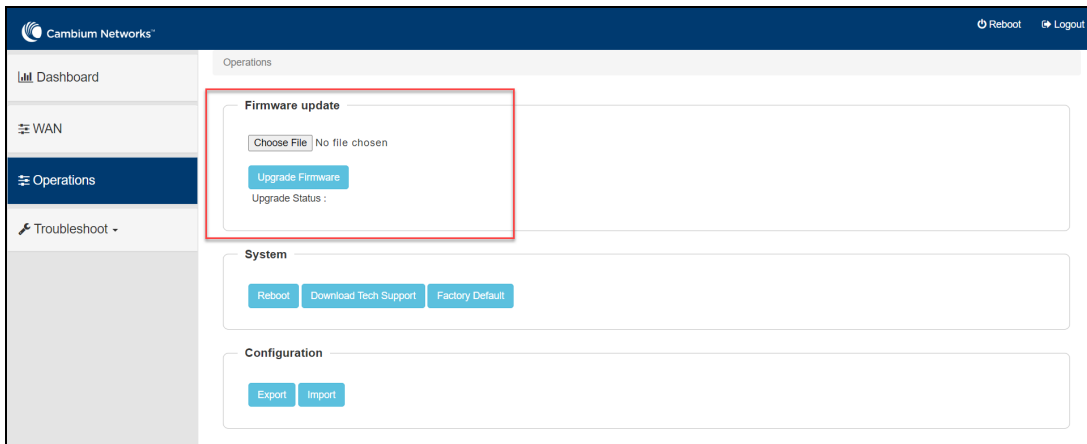

2. Set the values for each parameter, as described in [Table 5](#).

Table 5: Firmware update parameters

Parameters	Description
Choose File	To upload a local file (internally), perform the following steps: <ol style="list-style-type: none"> Click Choose File in the choose file field. A file browser window appears. Browse the location where you have saved the Firmware file on your machine locally. Select the file and click Open. The local import file is selected.
Upgrade Firmware	To initiate upgrade once the file is selected.
Upgrade Status	To view the status of the upgrade in the field.

3. Click **Upgrade Firmware**.

System

This section provides multiple troubleshooting tools provided by NSE 3000.

1. From the main NSE 3000 dashboard page, navigate to the **Operation** page > **System** section.

The **Operation** page appears, as shown in [Figure 14](#).

Figure 14: System section

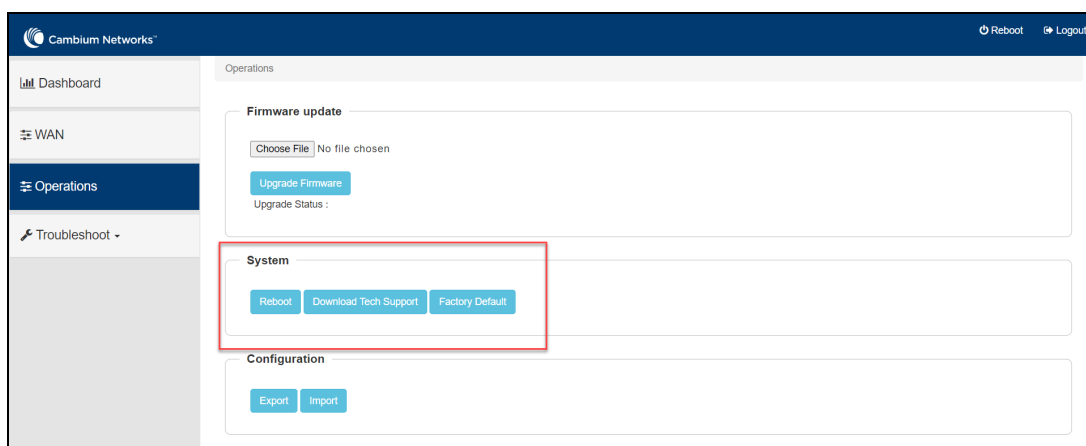

2. Set the values for each parameter, as described in [Table 6](#).

Table 6: System parameters

Parameters	Description
Reboot	A pop-up window appears requesting confirmation for reboot. If yes, the device reboots.
Download Tech Support	A pop-up window appears requesting permission to download tech support from UI. If yes, the file will be saved in your default download path configured on your system.
Factory Default	A pop-up window appears requesting confirmation for factory defaults. If yes, the device will delete all configurations to factory reset and reboot.

Configuration

The device configuration can either be exported from the device as a text file or imported into the device from a previous backup. Ensure that when a configuration file is imported onto the device, a reboot is necessary to activate that new configuration.

1. From the main NSE 3000 dashboard page, navigate to **Operation** page > **Configuration** section.

The **Operation** page appears, as shown in [Figure 14](#).

Figure 15: Configuration

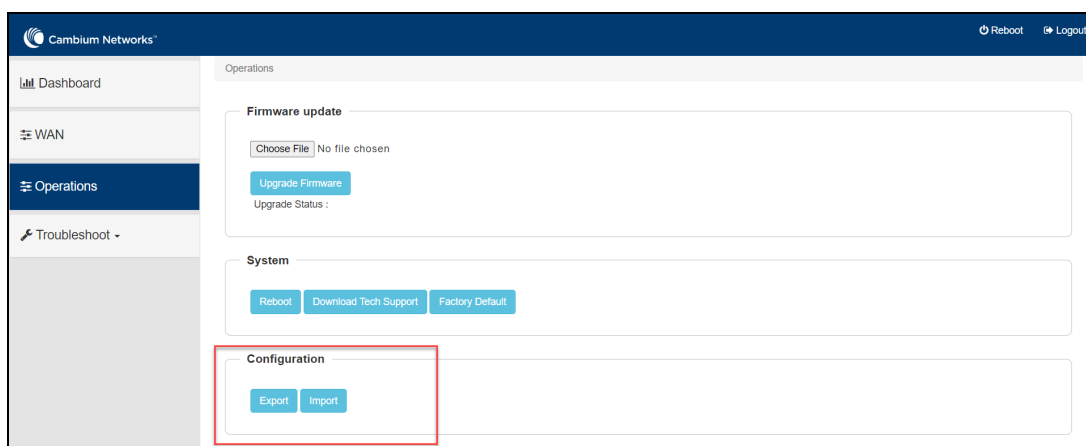

2. Set the values for each parameter, as described in [Table 7](#).

Table 7: Configuration parameters

Parameters	Description
Export	When you click the Export button, the NSE 3000 model configuration is downloaded by the device.
Import	<p>An option to select a location (stored) from where you to import the required data configuration. A local import file (which is saved locally) is uploaded by the browser.</p> <p>To upload a local file (internally), perform the following steps:</p> <ol style="list-style-type: none"> Click Import in the choose file field. A file browser window appears. Browse the location where you have saved the Import file on your machine locally. Select the file and click Open. The local import file is selected.

Troubleshoot

This chapter provides detailed information about troubleshooting methods supported by NSE. Troubleshooting methods supported by NSE devices as shown below:

- [Connectivity](#)
- [Logs](#)

Connectivity

This tool helps to check the accessibility of remote hosts from NSE devices. Three types of tools are supported under this category:

- [Ping](#)
- [DNS Lookup](#)
- [Traceroute](#)

Ping

To check the Ping result, perform the following steps:

1. Navigate to **Troubleshoot > Connectivity**.
2. Select **Test Type** as **Ping** from the drop-down list as shown in [Figure 16](#).

Figure 16: Ping connectivity

Troubleshoot / Connectivity

Test Type :

IP Address or Hostname :

Number of Packets : Min = 1, Max = 10

Buffer Size : Min = 1, Max = 65507

Ping Result

3. Set the values for each parameter, as described in [Table 8](#).

Table 8: Ping parameters

Parameters	Description
IP Address or Hostname	Validates the IPv4 address or Hostname reachability of the destination host.

Parameters	Description
Number of Packets	Specify the number of packets for this connectivity (Min = 1 and Max = 10).
Buffer Size	Specify the buffer size for this connectivity (Min = 1 and Max = 65507).
Ping Result	Displays the ping results.

4. Click **Start Ping**.

DNS Lookup

To check the DNS test result, perform the following steps:

1. Navigate to **Troubleshoot > Connectivity**.
2. Select **Test Type** as **DNS Lookup** from the drop-down list as shown in [Figure 17](#).

Figure 17: DNS Lookup connectivity

The screenshot shows the 'Troubleshoot / Connectivity' interface. It features a 'Test Type' dropdown menu set to 'DNS Lookup', a 'Host Name' input field, and a blue 'DNS Test' button. Below these fields is a large, empty box labeled 'DNS Test Result'.

3. Set the values for each parameter, as described in [Table 9](#).

Table 9: DNS Lookup parameters

Parameters	Description
Host Name	Specify the hostname of this connectivity.
DNS Test Result	Displays the IPs that are associated with configured Hostname.

4. Click **DNS Test**.

Traceroute

To check the Traceroute result, perform the following steps:

1. Navigate to **Troubleshoot > Connectivity**.
2. Select **Test Type** as **Traceroute** from the drop-down list as shown in [Figure 18](#).

[Figure 18](#): Traceroute connectivity

Troubleshoot / Connectivity

Test Type : Traceroute

IP Address or Hostname : Enter a valid < IP address >

Fragmentation : Off On

Trace Method : ICMP Echo UDP

Display TTL : Off On

Verbose : Off On

Start Traceroute

Traceroute Result

3. Set the values for each parameter, as described in [Table 10](#).

Table 10: Traceroute parameters

Parameters	Description
IP Address or Hostname	Specify the Valid IP address or Hostname for this connectivity.

Parameters	Description
Fragmentation	Allows to on or off fragmentation.
Trace Method	Allows to specify the trace method as ICMP Echo or UDP.
Display TTL	Allows to on or off the display TTL.
Verbose	Allows to on or off the verbose.
Traceroute Result	Displays the result of the traceroute.

4. Click **Start Traceroute**.

Logs

Two types of tools are supported under this category:

- [Events](#)
- [Debug Logs](#)

Events

NSE 3000 devices generate events that are necessary for troubleshooting across. NSE 3000 device generates events for troubleshooting.

1. Navigate to **Troubleshoot > Logs > Events** tab.

The **Events** page appears, as shown in [Figure 19](#).

[Figure 19: Events](#)

Date	Severity	Mnemonic	Message
Jun 7 11:31:25	Warning	WANLB-LINK-UP	WAN interface [br0.1] up
Jun 7 11:31:05	Error	WANLB-LINK-DOWN	WAN interface [br0.1] down
Jun 7 11:26:25	Warning	WANLB-LINK-UP	WAN interface [br0.1] up
Jun 7 11:26:21	Error	WANLB-LINK-DOWN	WAN interface [br0.1] down
Jun 7 11:19:25	Warning	WANLB-LINK-UP	WAN interface [br0.1] up
Jun 7 11:19:07	Error	WANLB-LINK-DOWN	WAN interface [br0.1] down
Jun 2 13:09:44	Error	WANLB-LINK-DOWN	WAN interface [br0.2] down
May 25 09:10:06	Warning	WANLB-LINK-UP	WAN interface [br0.1] up

2. View the data of Events device parameters, as described in [Table 11](#).

Table 11: Events parameters

Parameters	Description
Date	Displays the date and time at which the event was created.
Severity	Displays the severity of logs that must be forwarded to the server.
Mnemonic	Displays the mnemonic of the device.
Message	Displays the message that are sent to the NSE 3000 device.
Refresh	Allows to refresh the event logs.

Debug Logs

NSE 3000 devices support multi-level logging, which will ease debug issues.

To create a Debug Logs, perform the following steps:

1. Navigate to **Troubleshoot > Logs > Debug Logs** tab.

The Debug Logs page appears, as shown in [Figure 20](#).

Figure 20: Debug Logs page

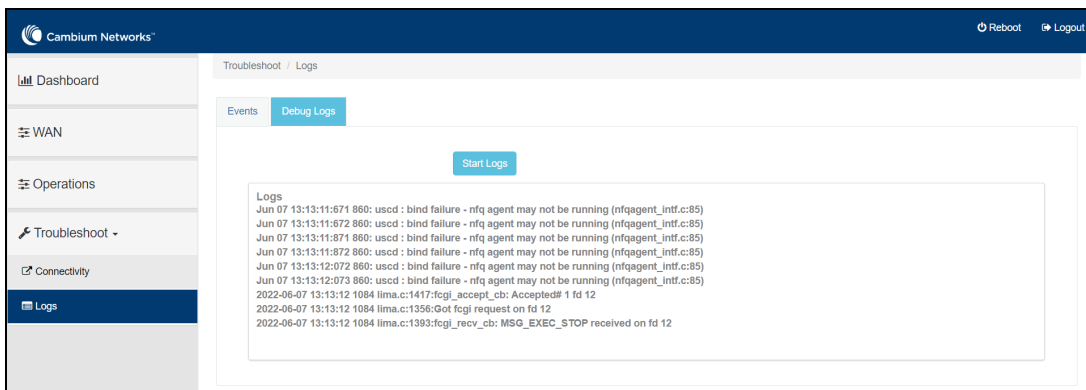

2. View the data of **Debug Logs** device parameters, as described in [Table 11](#).

Table 12: Events parameters

Parameters	Description
Start Logs	Initiates the Log collection process.
Logs	Displays the logs of the NSE 3000 device.

3. Click **Start Logs**.

Glossary

Term	Definition
AP	Access Point Module. One module that distributes network or Internet services to subscriber modules.
API	Application Program Interface
ARP	Address Resolution Protocol. A protocol defined in RFC 826 to allow a network element to correlate a host IP address to the Ethernet address of the host.
BT	Bluetooth
DFS	See Dynamic Frequency Selection
DHCP	Dynamic Host Configuration Protocol defined in RFC 2131. The protocol that enables a device to be assigned a new IP address and TCP/IP parameters, including a default gateway, whenever the device reboots. Thus, DHCP reduces configuration time, conserves IP addresses, and allows modules to be moved to a different network within the system.
Ethernet Protocol	Any of several IEEE standards that define the contents of frames that are transferred from one network element to another through Ethernet connections.
FCC	Federal Communications Commission of the U.S.A.
GPS	Global Positioning System. A network of satellites that provides absolute time to networks on earth, which use the time signal to synchronize transmission and reception cycles (to avoid interference) and to provide reference for troubleshooting activities.
UI	User interface.
HTTP	Hypertext Transfer Protocol, used to make the Internet resources available on the World Wide Web.
HTTPS	Hypertext Transfer Protocol Secure
HT	High Throughput
IP Address	The 32-bit binary number identifies a network element by both network and host. See also Subnet Mask.
IPv4	The traditional version of Internet Protocol, defines 32-bit fields for data transmission.
LLDP	Link Layer Discovery Protocol
MAC Address	Media Access Control address. The hardware address that the factory assigns to the module for identification in the Data Link layer interface of the Open Systems Interconnection system. This address serves as an electronic serial number.
MIB	Management Information Base. Space that allows a program (agent) in the network to relay information to a network monitor about the status of defined variables (objects).
MIR	See Maximum Information Rate.
PPPoE	Point to Point Protocol over Ethernet. Supported on SMs for operators who use PPPoE in other parts of their network operators who want to deploy PPPoE to realize per-subscriber authentication, metrics, and usage control.

Term	Definition
Proxy Server	Network computer that isolates another from the Internet. The proxy server communicates for the other computer, and sends replies to only the appropriate computer which has an IP address that is not unique or not registered.
PoE	Power over Ethernet.
SLA	Service Level Agreement
VLAN	Virtual local area network. An association of devices through software that contains broadcast traffic, as routers would, but in the switch-level protocol.
VPN	A virtual private network for communication over a public network. One typical use is to connect remote employees, who are at home or in a different city, to their corporate network over the Internet. Any of several VPN implementation schemes are possible. SMs support L2TP over IPSec (Level 2 Tunneling Protocol over IP Security) VPNs and PPTP (Point to Point Tunneling Protocol) VPNs, regardless of whether the Network Address Translation (NAT) feature enabled.

Cambium Networks

Cambium Networks delivers wireless communications that work for businesses, communities, and cities worldwide. Millions of our radios are deployed to connect people, places, and things with a unified wireless fabric that spans multiple standards and frequencies of fixed wireless and Wi-Fi, all managed centrally via the cloud. Our multi-gigabit wireless fabric offers a compelling value proposition over traditional fiber and alternative wireless solutions. We work with our Cambium certified Connected Partners to deliver purpose built networks for service provider, enterprise, industrial, and government connectivity solutions in urban, suburban, and rural environments, with wireless that just works.

Support website	https://support.cambiumnetworks.com
Support enquiries	
Technical training	https://learning.cambiumnetworks.com/learn
Main website	http://www.cambiumnetworks.com
Sales enquiries	solutions@cambiumnetworks.com
Warranty	https://www.cambiumnetworks.com/support/standard-warranty/
Telephone number list	http://www.cambiumnetworks.com/contact-us/
User Guides	http://www.cambiumnetworks.com/guides
Address	Cambium Networks Limited, Unit B2, Linhay Business Park, Eastern Road, Ashburton, Devon, TQ13 7UP United Kingdom



www.cambiumnetworks.com

Cambium Networks and the stylized circular logo are trademarks of Cambium Networks, Ltd. All other trademarks are the property of their respective owners.

Copyright © 2022 Cambium Networks, Ltd. All rights reserved.