

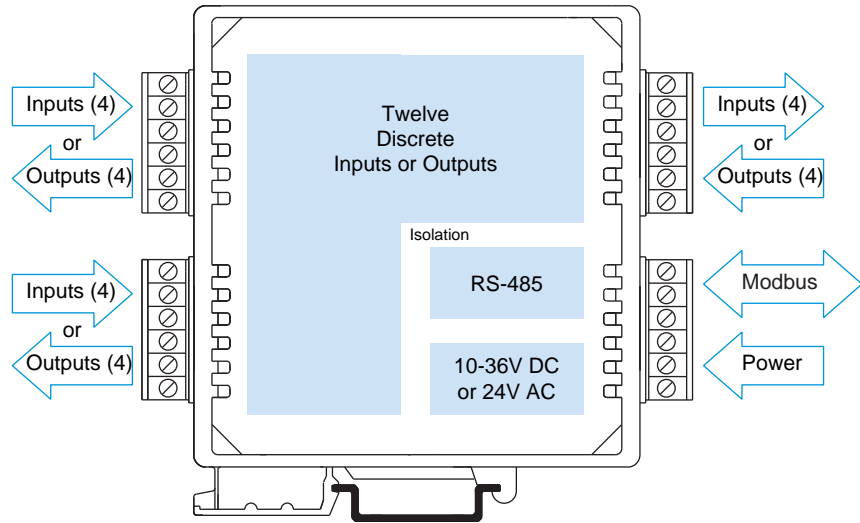

Modbus/RS-485



High-Density Discrete I/O Module



901/902/903MB Multi-Channel Discrete I/O Modules

Active-Low Inputs Sinking Outputs (Low-Side Switching)

Models

- 901MB: 12 input channels
- 902MB: 12 output channels
- 903MB: 12 input/output channels

Input

Twelve input channels (901, 903 models only)
0 to 35V DC

Output

Twelve output channels (902, 903 models only)
0 to 35V DC

Network Communication

Modbus-RTU high-speed RS-485

Power Requirement

10 to 36V DC,
24V AC

Approvals

CE marked. UL, cUL listed
Class I; Division 2; Groups A, B, C, D.

Description

These modules provide twelve discrete input and/or output channels. Isolation separates the I/O, power, and network circuits. Network communication adheres to the industry-standard RS-485 Modbus RTU protocol. Both AC and DC power sources are supported with wide range, nonpolarized, diode-coupled terminals.

The open-drain outputs are intended for current-sinking or low-side switching applications. The buffered inputs are active-low. These models are the complement of the 904, 905, and 906 units which have open-source, high-side output switches and active-high inputs. Socketed pull-up resistors are easily removed or exchanged to satisfy your application requirements.

The 903MB model has twelve input/output points that may be used as inputs or outputs on a bit-by-bit basis. Outputs may be read back to verify output settings.

Combining flexible I/O types, wide I/O ranges, and a network interface in a single package, makes this instrument extremely powerful. Multi-channel design adds cost-efficiency and allows high-density mounting. Plus, safe, rugged construction makes these modules reliable for use in both control room and distributed field I/O applications. Custom module configurations are also possible (consult factory for details).

Special Features

- Standard Modbus RTU protocol with high-speed RS-485 communication (up to 115K bps)
- Twelve I/O channels in a single inch-wide unit reduces system costs and saves panel space
- High-voltage, high-current, open-drain outputs enable direct (low-side) control of external devices
- High-voltage buffered inputs monitor discrete levels from a variety of industrial devices
- Tandem input/output circuitry (903 models only) connects input buffers with open-drain outputs for convenient loopback monitoring of the output state
- Outputs have built-in over-temperature and over-current shut-down protection, plus active clamping circuits for switching inductive loads
- Watchdog timers provide a configurable failsafe output state for use when host I/O communication is lost
- Three-way isolation eliminates potential ground loops between power, I/O, and network circuitry
- Self-diagnostics monitor microcontroller activity to detect operational failures (lock-up) and execute a reset to restore communication



Performance

Discrete Inputs (901 & 903 models only)

Input Type

12 active-low, buffered inputs, with a common connection. Inputs include transient suppression devices and series connected 100K ohm resistors, plus diode over-voltage clamps to the internal +5V supply.

Input Signal Voltage Range

0 to 35V DC, maximum.

Input Current

293µA, typical at 35V DC.

Input Signal Threshold

TTL compatible with 100mV of hysteresis, typical. Low-to-High threshold is 1.7VDC, High-to-Low is 1.6VDC, typical. Limited to TTL levels of 0.8VDC (max. LOW level) and 2.0VDC (min. HIGH level).

Input Resistance

100K ohms, typical.

Input Hysteresis

100mV DC, typical.

Discrete Outputs (902 & 903 models only)

Output Type

12 independent, open-drain, DMOS MOSFET switches with a common source connection that operate as low-side switches.

Output Voltage Range

0 to 35V DC max. (0 to 500mA/channel continuous). External voltage source required.

Output ON Resistance

0.28 ohms maximum.

Output Response Time

Force Single Coil: Output updates within 250µs of receipt of a command.

Force Multiple Coils: First coil updates in 250µs, followed successively by additional coils every 180µs.

General

I/O Pull-ups and Socket

5.6K ohm pull-up resistor SIPs are installed in sockets at each port (four-channels per port).

Excitation (per port)

External excitation voltage for each four-channel port is limited to 35V or less.

Supported Modbus Commands

The command/response protocol for communicating with this module adheres to the Modbus/RTU standard for the following Modbus Functions.

- Read Coil (Output) Status
- Read Input Status
- Read Holding Registers
- Force Single Coil (Output)
- Preset Single Register
- Reset Slave
- Force Multiple Coils (Outputs)
- Preset Multiple Registers
- Report Slave ID

LED Indicators

LEDs indicate power, status, and discrete level.

Power Requirements

10 to 36V DC,
22 to 26V AC.

Supply Current

Supply	Current Draw
10V DC	130mA maximum
24V DC	54mA maximum
24V AC	95mA maximum

Isolation

1500V AC for 60 seconds or 250V AC continuous. 3-way isolation between I/O, network, and power circuits.

Ordering Information

Models

901MB-0900
Discrete input module

902MB-0900
Discrete output module

903MB-0900
Discrete input/output module

Accessories

900C-SIP

Configuration Software Interface Package (includes software CD-ROM for Windows, RS-232/485 converter, and RS-485/three-wire cable)

4001-095

USB-to-RS232 adapter. See page 70 for more info.

TBK-B02

Optional terminal block kit, barrier strip style, 4 pcs.

TBK-S02

Optional terminal block kit, spring clamp style, 4 pcs.

P55R-D24

Power supply (24V DC, 2.1A).
See Power Supplies on Page 199.

For more information on software, network hardware, and mounting accessories, please see Pages 69-71.

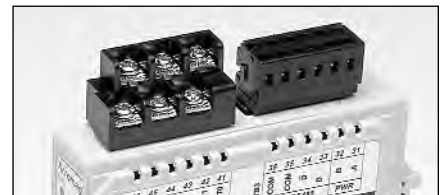

Optional terminal blocks: barrier strip (left) and spring clamp (right). Cage clamp terminal is standard.

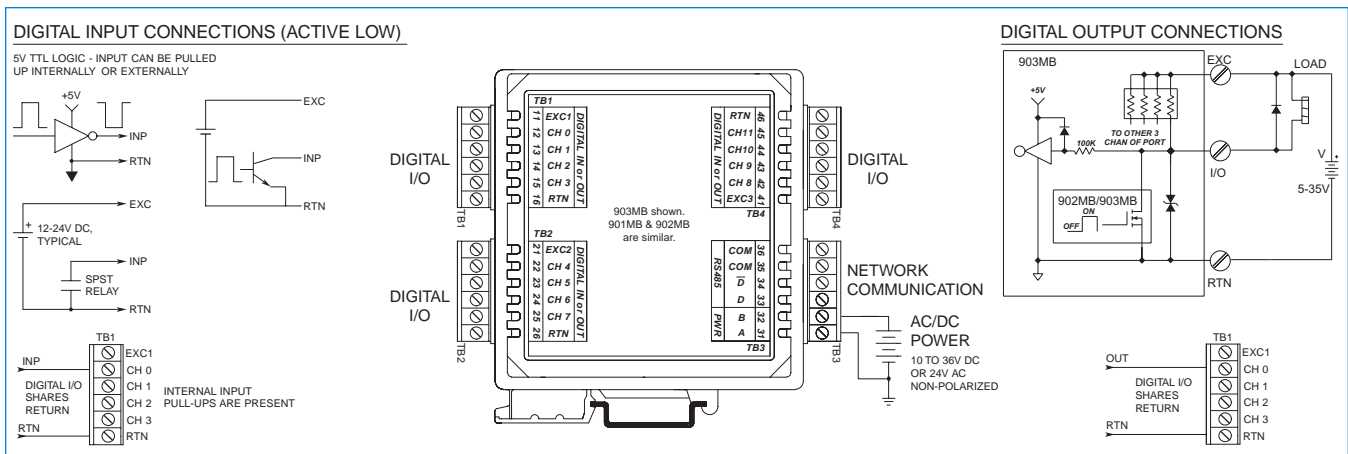



900MB Series Technical Diagrams

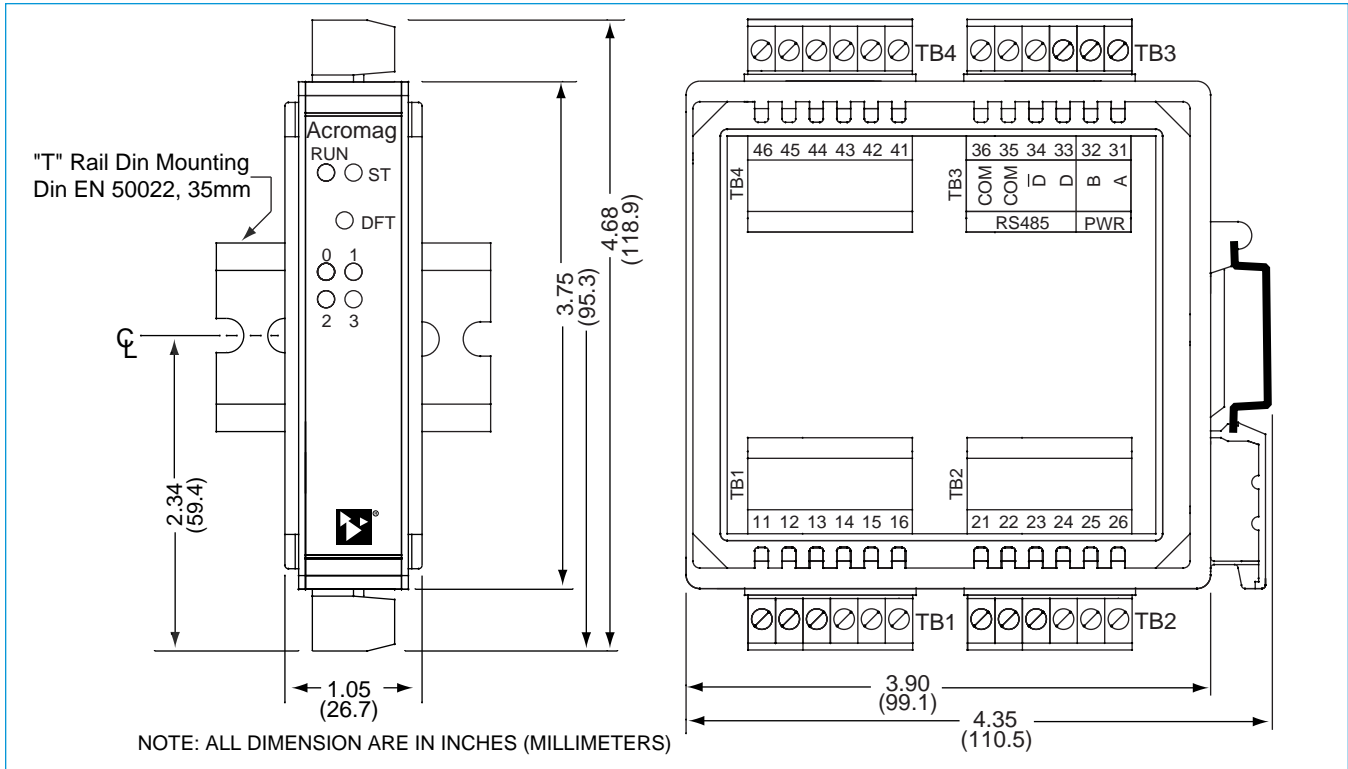

PERSONAL COMPUTER
W/ WINDOWS 95/98 OR NT



INSTALL MODBUS CONFIGURATION SOFTWARE

RS-232 SERIAL PORT CONNECTOR AT BACK OF PC

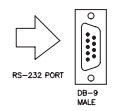

CONNECT THE RS-232 SIDE OF CONVERTER TO THE PC

RS-232 TO RS-485 CONVERTER MODEL 5034-214

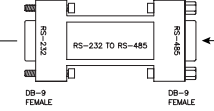

CONNECT THE RS-485 SIDE OF CONVERTER TO THE CABLE

CABLE 5034-202

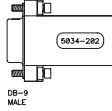

CAUTION: DO NOT CONNECT THE CABLE DIRECTLY TO THE PC WITHOUT THE CONVERTER, OR DAMAGE TO THE MODULE MAY RESULT.

900C-SIP COMMUNICATION CONNECTIONS

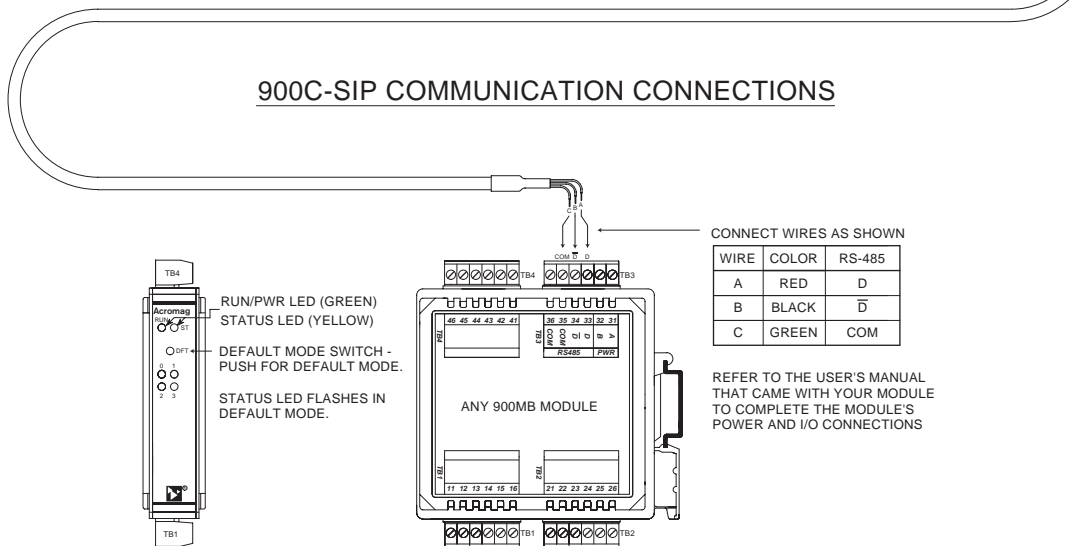



Configuration Kit

Software Interface Package
Model No. 900C-SIP

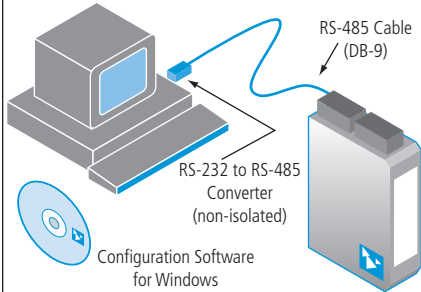

Software Interface Package

This package includes Windows® Configuration Software, an RS-232-to-485 Serial Port Converter, and an RS-485 Signal Cable. These components provide everything you need to set up a Series 900 I/O module from your desktop PC before installing it on the network.

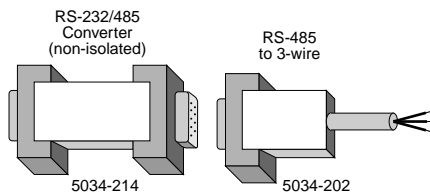

Ordering Information

900C-SIP
Software Interface Package.
Includes Configuration Software (5034-186), Non-isolated RS-232 to RS-485 Serial Port Converter (5034-214), and RS-485 Cable (5034-202).
Items can also be ordered separately below.

5034-186
Configuration Software for Windows (95/98/2000/ME/NT4/XP) on CD-ROM.

5034-214
Non-isolated RS-232 to RS-485 Serial Port Converter, DB-9F to DB-9F.

5034-202
RS-485 to 3-wire Cable Converter, DB-9M to 3 x 12AWG RS-485 Cable, 8 ft.

Network Power

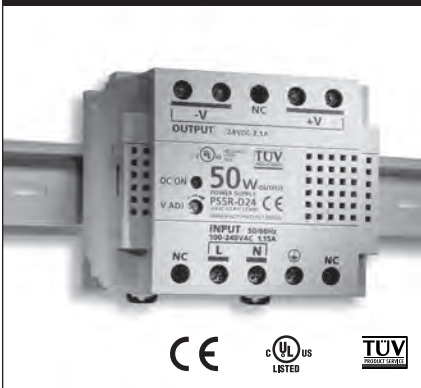

Universal 50W Power Supply

The PS5R-D24 is the ideal power source to drive your network.

Input Power Requirement
Universal power
85 to 264V AC,
105 to 370V DC

Output
24V DC, 2.1A (50W)

Ordering Information

PS5R-D24
Universal Power Supply

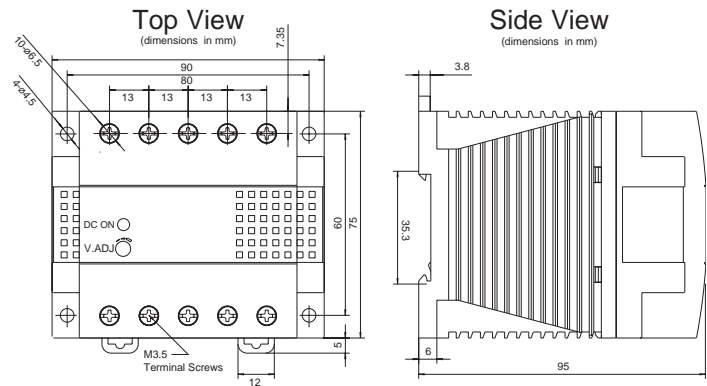

Mounting Hardware



DIN-Rail Mounting

For your convenience, Acromag offers several mounting accessories to simplify your system installation. Our 19" rack-mount kit provides a clean solution for mounting your I/O modules and a power supply. Or you can buy precut DIN rail strips for mounting on any flat surface.

Ordering Information

20RM-16-DIN
19" rack-mount kit with DIN rail.

DIN RAIL 3.0
DIN RAIL 16.7
DIN rail strip, Type T, 3 inches (75mm) or 16.7 inches (425mm)

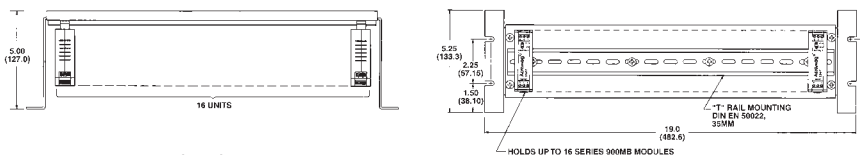

Dimensions in inches (mm).

Model 4001-095 USB-to-Serial Adapter

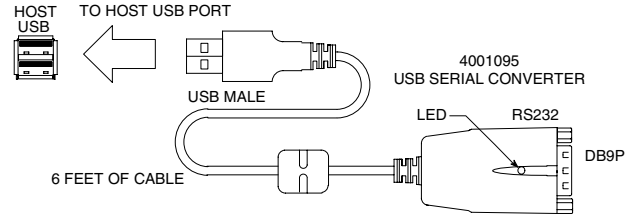
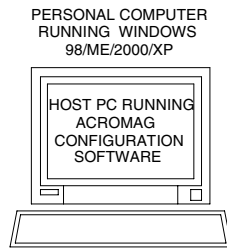

Simplifies configuration of Acromag I/O Modules ♦ Enables configuration via USB port

Description

This device is a USB-to-serial adapter that you can use to communicate with many Acromag I/O products for setup and re-configuration for your application.

Key Features & Benefits

- Connects to I/O modules via USB (other adapters may be necessary)
- Complete RS232 control signals
- Conforms to USB Specification, Version 1.1
- USB-powered
- Cable length, 6 ft., UL approved

Performance Specifications

USB Specification
Version 1.1

Data rate
Up to 115.2Kbps

Environmental Standards
RoHS-compliant

Basic Power Consumption
150mA

PC Requirements
Windows® 7 (32-/64-bit) / Vista (32-/64-bit) / XP (32-/64-bit) / Server 2003 & 2008 (32-/64-bit) / 2000 / ME / 98SE / 98

Ordering Information

NOTE: For more information visit www.acromag.com.

Adapters

- 4001-095**
USB to serial adapter. Includes driver CD and manual.
- 5030-913**
Serial port adapter. DB9S connector to RJ11 jack.
- 5034-202**
RS-485 to 3-wire cable converter and cable, DB-9M to 3 x 12AWG RS-485 cable, 8 ft.
- 5032-287**
RS-232 to 151T transmitter configuration device converter and cable, 6 ft.
- 5034-214**
Non-isolated RS-232 to RS-485 Serial Port Converter, DB-9F to DB-9F.

Cables

- 5030-902**
Cable. 6 feet long with RJ11 plug at each end.

IntelliPack 800x Series Adapter and Cable

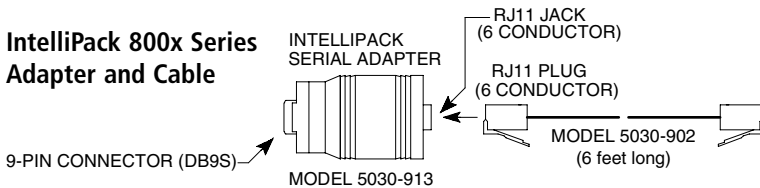

900MB Modbus Series Adapter and Cable

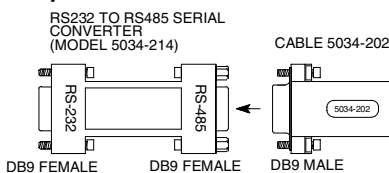

151T Transmitter Series Adapter and Cable

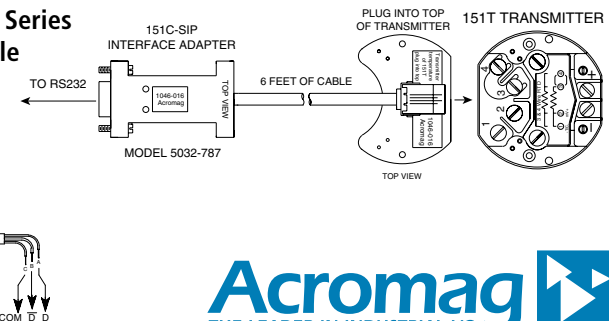

Tel: 248-295-0880 ■ Fax: 248-624-9234 ■ sales@acromag.com ■ www.acromag.com ■ 30765 S Wixom Rd, Wixom, MI 48393 USA