

Korenix JetNet 5010G Series Industrial Managed Ethernet Switch

User Manual

Version 2.2, Jun, 2008



www.korenix.com

Korenix JetNet 5010G Series Industrial Managed Ethernet Switch User's Manual

Copyright Notice

Copyright © 2006-2008 Korenix Technology Co., Ltd.

All rights reserved.

Reproduction in any form or by any means without permission is prohibited.

Federal Communications Commission (FCC) Statement

This equipment has been tested and found to comply with the limits for a Class A digital device, pursuant to Part 15 of the FCC Rules. These limits are designed to provide reasonable protection against harmful interference when the equipment is operated in a commercial environment. This equipment generates, uses, and can radiate radio frequency energy and, if not installed and used in accordance with the instruction manual, may cause harmful interference to radio communications. Operation of this equipment in a residential area is likely to cause harmful interference in which case the user will be required to correct the interference at his expense.

The user is cautioned that changes and modifications made to the equipment without approval of the manufacturer could void the user's authority to operate this equipment.

Index

1	Introduction.....	2
1.1	Overview.....	2
1.2	Major Features	2
1.3	Package List.....	3
2	Hardware Installation.....	4
2.1	Hardware Introduction.....	4
2.2	Wiring Power Inputs	6
2.3	Wiring Digital Input.....	7
2.4	Wiring Digital Output	7
2.5	Wiring Earth Ground	7
2.6	Wiring Fast Ethernet Ports.....	7
2.7	Wiring Combo Ports	8
2.8	Wiring RS-232 Console Cable.....	8
2.9	DIN-Rail Mounting Installation.....	8
2.10	Wall-Mounting Installation	10
3	Preparation for Management.....	12
3.1	Preparation for Serial Console.....	12
3.2	Preparation for Web Interface	13
3.3	Preparation for Telnet Console	15
4	Feature Configuration	18
4.1	Command Line Interface Introduction.....	19
4.2	Basic Setting	24
4.3	Port Configuration	39
4.4	Network Redundancy.....	46
4.5	VLAN	55
4.6	Traffic Prioritization.....	63
4.7	Multicast Filtering.....	68
4.8	SNMP.....	72
4.9	Security	76
4.10	Warning.....	83
4.11	Monitor and Diag.....	92
4.12	Device Front Panel.....	98
4.13	Save to Flash.....	99
4.14	Logout.....	100
5	Appendix.....	101
5.1	Product Specification.....	101

5.2	Pin Assignment of the RS-232 Console Cable	104
5.3	Korenix SFP family	105
5.4	Korenix Private MIB.....	106
5.5	Revision History	107
5.6	About Korenix	108

1 Introduction

Welcome to Korenix *JetNet 5010G* Series Industrial Managed Ethernet Switch User Manual. Following topics are covered in this chapter:

1.1 Overview

1.2 Major Features

1.3 Package Checklist

1.1 Overview

JetNet 5010G series, Industrial 10-port Managed Ethernet Switches, have 7 10/100Base-TX ports and 3 combo ports, respectively 10/100/1000 RJ-45 / 100-FX / Gigabit SX/LX. *JetNet 5010G* is especially designed to operate under harsh environmental conditions. The switches provide solid foundation for a highly fault-tolerant and easily-managed network. *JetNet 5010G* can be remotely configured by Telnet, Web browser, JetView and managed by Simple Network Management Protocol (SNMP) and Remote Monitoring (RMON). You can also connect the attached RS232 console cable to manage the switch by Command Line Interface (CLI). CLI commands are Cisco-Like commands, your engineers who are familiar with Cisco products don't need to learn new rules for CLI commands.

Security is enhanced with advanced features such as 802.1Q VLAN and Port/IP security. Performance is optimized by QoS and IGMP Snooping/Query. Korenix 3rd generation Ring technology, Multiple Super Ring, enables superb self-healing capability for network failure. The fastest failover time is enhanced from 300ms to 5ms for 10/100TX RJ-45 ports, and 30ms for 100FX and Gigabit Fiber. This is Korenix patented ring technology, which is registered in most countries. For interoperability with your existed network, *JetNet 5010G* series also come with an advanced redundant network solution, Ring Coupling and Rapid Dual Homing technology. With Ring Coupling and Rapid Dual Homing technology, Ethernet Ring can be extended more easily. No matter with Korenix switch or other managed switches.

The IP31-design aluminum case further strengthens *JetNet 5010G*'s withstand ability in harsh industrial environment. The event warning is notified to the network administrator via e-mail, system log, or to field engineers by relay output. *JetNet 5010G* Series Industrial Managed Ethernet Switch has also passed CE/ FCC/ UL safety certifications to help ensure safe and reliable data transmission for industrial applications. *JetNet 5010G* Series will be your best option for highly-managed industrial network.

1.2 Major Features

Korenix *JetNet 5010G* Series products have the following features:

- 7 10/100 Base TX and 3 Gigabit RJ-45/SFP combo (10/100/1000 Base-TX, 100 FX, Gigabit SX/LX)
- 32G switch Fabric, 8K MAC address
- Patented Multiple Super Ring (MSR), minium Recovery time <5ms

- Rapid Daul Homing, which allows switch connect to third party network with maximum 7 multiple redundant paths.
- Embedded Hardware Watchdog timer to auto reset when failure
- LACP/VLAN/GVRP/QoS/IGMP Snooping/IGMP Query/Rate Control/ Online Multi-Port Mirroring
- Secured by IEEE 802.1x, Port Security, Access IP list, SSH and HTTPS Login
- Event Notification by E-mail, SNMP trap and SysLog
- Cisco-Like CLI, Web, SNMP/RMON, and JetView for network Management
- Redundant DC Power Inputs, Digital Input and Relay Output
- 1.5KV Hi-Pot Protection for ports and power
- Industrial Heat dispersing design, -10~70°C operating temperature, Rigid Aluminum Case Complies with IP31

Note: The detail spec is listed in Appendix 5.1.

1.3 Package List

Korenix JetNet 5010G Series products are shipped with following items:

- One industrial Managed Ethernet switch
- One DIN-Rail clip (attached to the switch)
- One wall mounting plate and six screws
- One RS-232 DB-9 to RJ-45 console cable
- Documentation and Software CD
- Quick Installation Guide

If any of the above items are missing or damaged, please contact your local sales representative.

2 Hardware Installation

This chapter includes hardware introduction, installation and configuration information.

Following topics are covered in this chapter:

2.1 Hardware Introduction

Dimension

Panel Layout

Bottom View

2.2 Wiring Power Inputs

2.3 Wiring Digital Input

2.4 Wiring Relay Output

2.5 Wiring Ethernet Ports

2.6 Wiring Combo Ports

2.7 Wiring RS-232 console cable

2.8 DIN-Rail Mounting Installation

2.9 Wall-Mounting Installation

2.1 Hardware Introduction

Dimension

JetNet 5010G Industrial Gigabit Switch dimension (W x H x D) is **96mm x 137mm x 119mm**

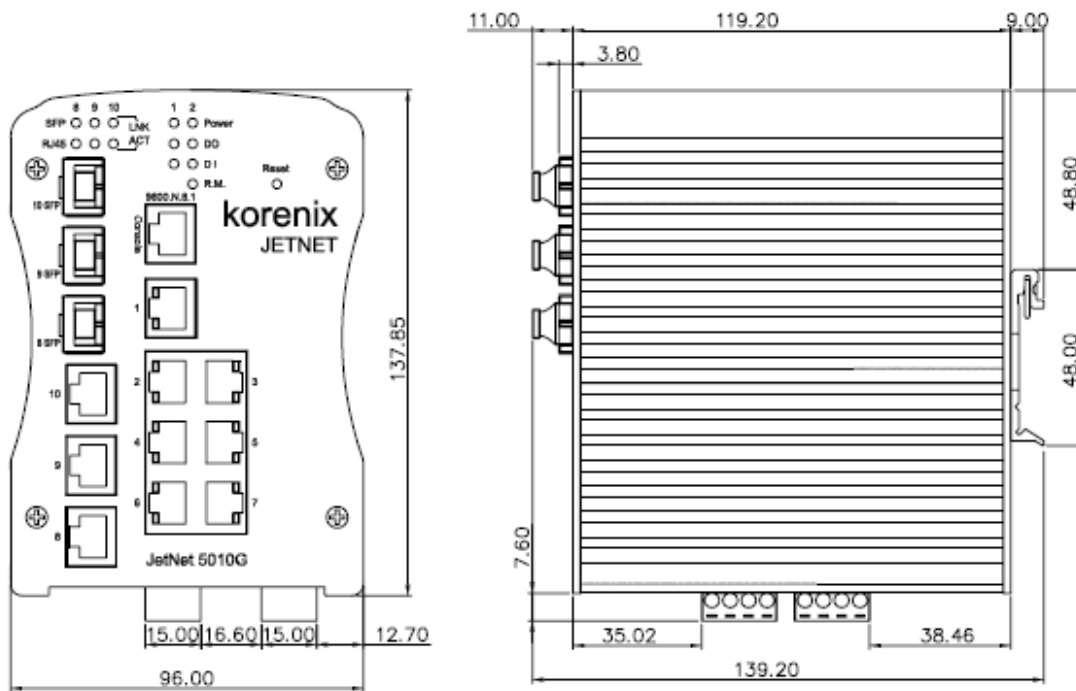

Panel Layout

The front panel includes 10/100Mbps Fast Ethernet ports, Gigabit Ethernet ports, SFP slot, RS232 console port, System / Combo Port LED and Reset button.

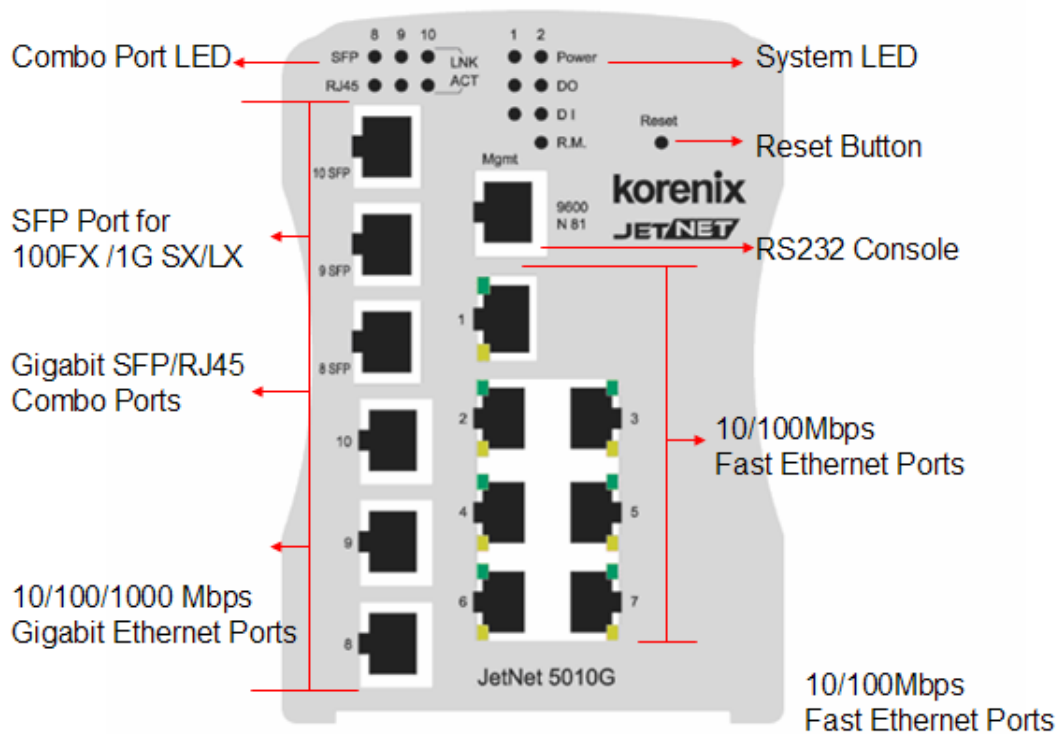

Bottom View

The bottom view of the JetNet 5010G Industrial Gigabit Managed Switch consists of three terminal block connectors with two DC power inputs, two Digital Inputs, 2 Relay Outputs and 1 Earth Ground.

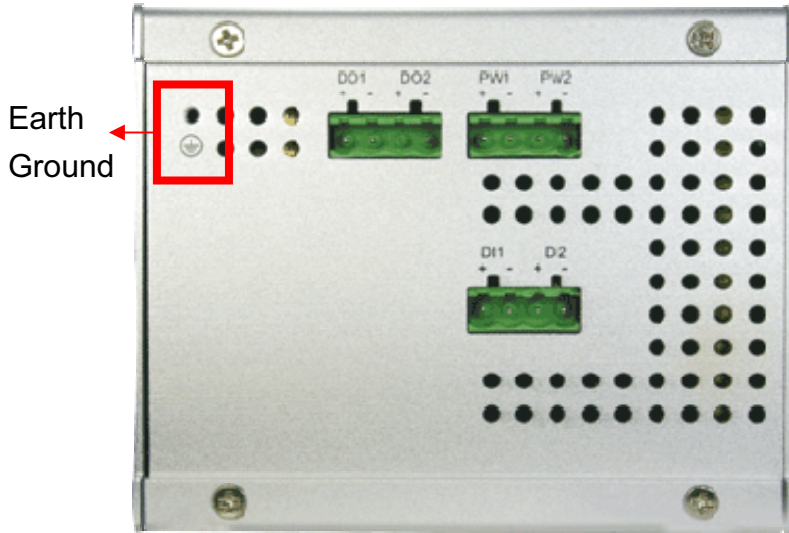

2.2 Wiring Power Inputs

Follow below steps to wire JetNet 5010G redundant DC power inputs.



1. Insert positive and negative wires into V+ and V- contacts respectively of the terminal block connector
2. Tighten the wire-clamp screws to prevent DC wires from being loosened.
3. Power 1 and Power 2 support power redundancy and polarity reverse protection functions.
4. Positive and negative power system inputs are both accepted, but Power 1 and Power 2 must apply the same mode.

Note 1: It is a good practice to turn off input and load power, and to unplug power terminal block before making wire connections. Otherwise, your screwdriver blade can inadvertently short your terminal connections to the grounded enclosure.

Note 2: The range of the suitable electric wire is from 12 to 24 AWG.

Note 3: If the 2 power inputs are connected, JetNet 5010G will be powered from the highest connected voltage. The unit will alarm for loss of power, either PWR1 or PWR2.

2.3 Wiring Digital Input

JetNet 5010G provides 2 digital inputs. It allows users to connect the termination units' digital output and manage/monitor the status of the connected unit. The Digital Input pin can be pulled high or low; thus the connected equipments can actively drive these pins high or low. The embedded software UI allows you to read and set the value to the connected device.

The power input voltage of logic low is DC 0~10V. Logic high is DC 11~30V.

Wire the digital input just like wiring the power input introduced in chapter 2.2.

2.4 Wiring Digital Output

JetNet 5010G provides 2 digital outputs, also known as Relay Output. The relay contacts are energized (open) for normal operation and will close for fault conditions. The fault conditions include power failure, Ethernet port link break or other pre-defined events which can be configured in JetNet 5010G UI.

Wiring digital output is exactly the same as wiring power input introduced in chapter 2.2.

2.5 Wiring Earth Ground

To ensure the system will not be damaged by noise or any electrical shock, we suggest you to make exact connection with JetNet 5010G with Earth Ground.

On the bottom side of JetNet 5010G, there is one earth ground screw. Loosen the earth ground screw by screw drive; then tighten the screw after earth ground wire is connected.

2.6 Wiring Fast Ethernet Ports

JetNet 5010G includes 7 RJ-45 Fast Ethernet ports. The fast Ethernet ports support 10Base-T and 100Base-TX, full or half duplex modes. All the fast Ethernet ports will auto-detect the signal from connected devices to negotiate the link speed and duplex mode. Auto MDI/MDIX allows users to connect another switch, hub or workstation without changing straight through or crossover cables.

Note that crossover cables simply cross-connect the transmit lines at each end to the received lines at the opposite end.

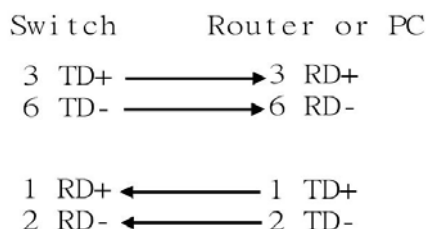

Straight-through Cabling Schematic

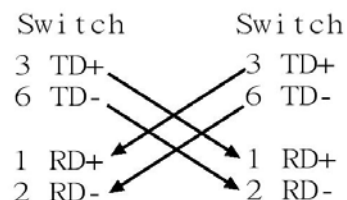

Cross-over Cabling Schematic

Note that Ethernet cables use pins 1, 2, 3, and 6 of an 8-pin RJ-45 connector. The signals of these pins are converted by the automatic MDI-X function, as shown in the table below:

Pin MDI-X	Signals	MDI Signals
1	RD+	TD+
2	RD-	TD-
3	TD+	RD+
6	TD-	RD-

Connect one side of an Ethernet cable into any switch port and connect the other side to your attached device. The LNK LED will light up when the cable is correctly connected. Refer to the **LED Indicators** section for descriptions of each LED indicator. Always make sure that the cables between the switches and attached devices (e.g. switch, hub, or workstation) are less than 100 meters (328 feet).

The wiring cable types are as below.

10Base-T: 2-pair UTP/STP Cat. 3, 4, 5 cable, EIA/TIA-568 100-ohm (100m)

100 Base-TX: 2-pair UTP/STP Cat. 5 cable, EIA/TIA-568 100-ohm (100m)

1000 Base-TX: 4-pair UTP/STP Cat. 5 cable, EIA/TIA-568 100-ohm (100m)

2.7 Wiring Combo Ports

JetNet 5010G includes 3 RJ-45 Gigabit Ethernet ports. The speed of the gigabit Ethernet port supports 10Base-T, 100Base-TX and 1000Base-TX. JetNet 5010G also equips 3 gigabit SFP ports combo with gigabit Ethernet ports. The speed of the SFP port supports 100Base-FX and 1000Base-SX/LX. The SFP ports accept standard MINI GBIC SFP transceiver. But, to ensure system reliability, Korenix recommends using the Korenix certificated Gigabit SFP Transceiver. The certificated SFP transceiver includes 100Base-FX single/multi mode, 1000Base-SX/LX single/multi mode ranger from 550m to 80KM.

2.8 Wiring RS-232 Console Cable

Korenix attaches one RS-232 DB-9 to RJ-45 cable in the box. Connect the DB-9 connector to the COM port of your PC, open Terminal tool and set up serial settings to 9600, N,8,1. (Baud Rate: 9600 / Parity: None / Data Bit: 8 / Stop Bit: 1) Then you can access CLI interface by console able.

Note: If you lost the cable, please contact with your sales or follow the pin assignment to buy a new one. The Pin assignment spec is listed in the appendix.

2.9 DIN-Rail Mounting Installation

The DIN-Rail clip is already attached to the JetNet 5010G when packaged. If the DIN-Rail clip is not screwed on the JetNet 5010G, follow the instructions and the figure below to attach DIN-Rail clip to JetNet 5010G.

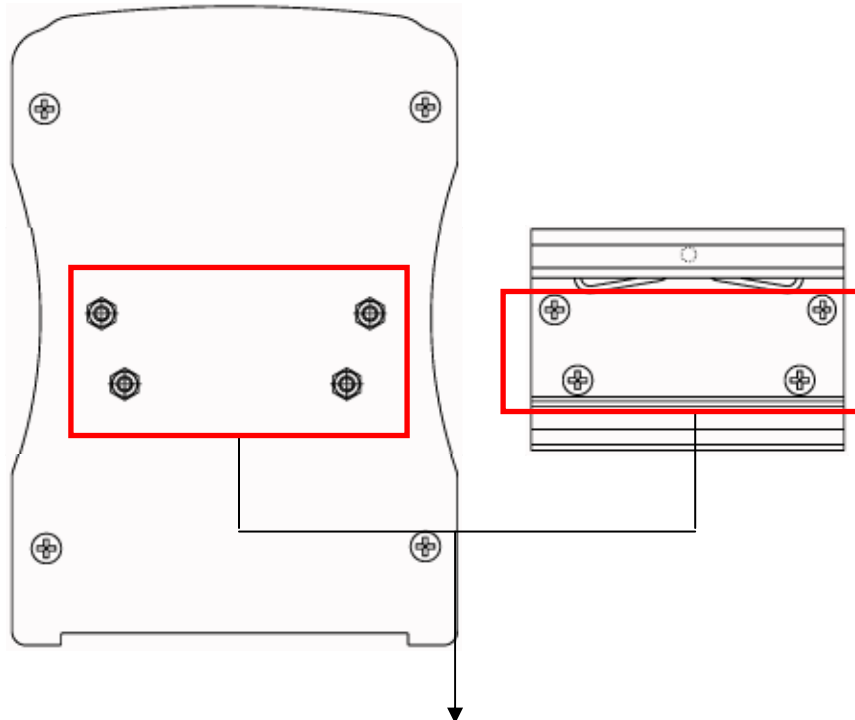

1. Use the screws to attach DIN-Rail clip to the rear panel of JetNet5010G.
2. To remove DIN-Rail clip, reverse step 1.

Follow the steps below to mount JetNet 5010G to the DIN-Rail track:

1. First, insert the upper end of DIN-Rail clip into the back of DIN-Rail track from its upper side.

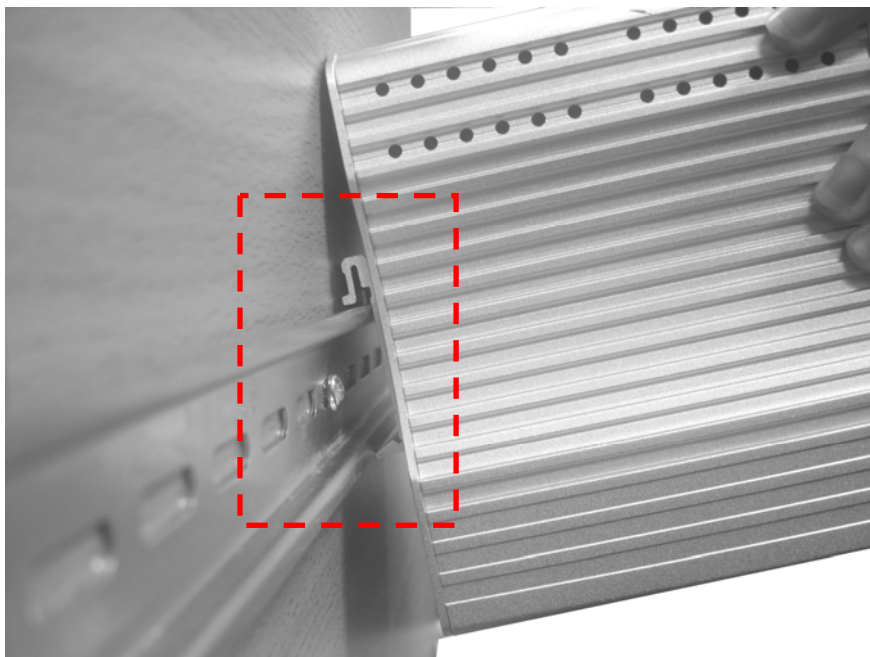

2. Lightly push the bottom of DIN-Rail clip into the track.

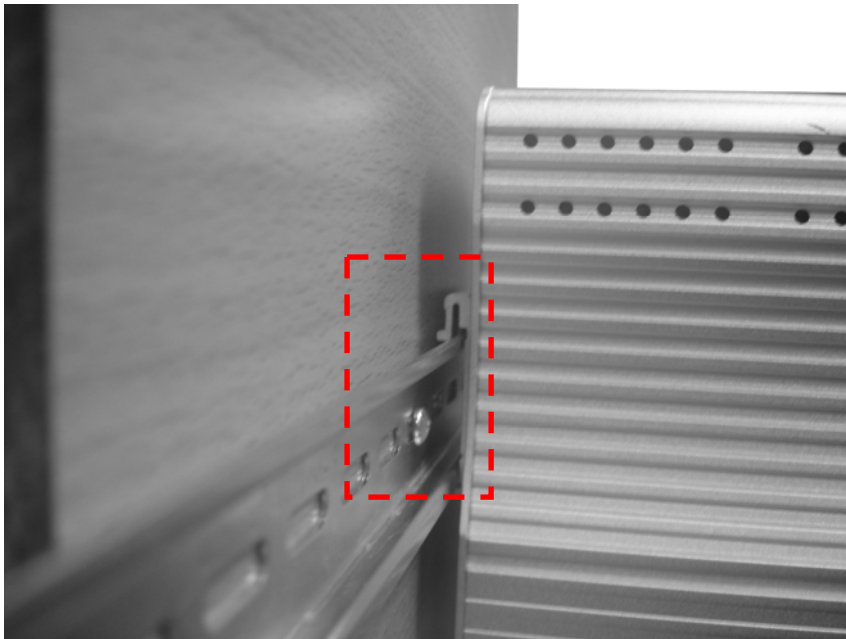

3. Check if DIN-Rail clip is tightly attached on the track.
4. To remove JetNet 5010G from the track, reverse the steps above.

2.10 Wall-Mounting Installation

Follow the steps below to install JetNet 5010G with the wall mounting plate.

1. To remove DIN-Rail clip from JetNet 5010G, loosen the screws from DIN-Rail clip.
2. Place the wall mounting plate on the rear panel of JetNet 5010G.
3. Use the screws to tighten the wall mounting plate onto JetNet 5010G.
4. Use the hook holes at the corners of the wall mounting plate to hang JetNet 5010G onto the wall.
5. To remove the wall mounting plate, reverse the steps above.

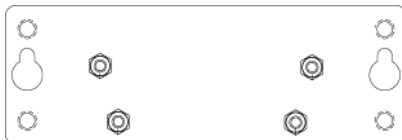

Mounting plate and screws.

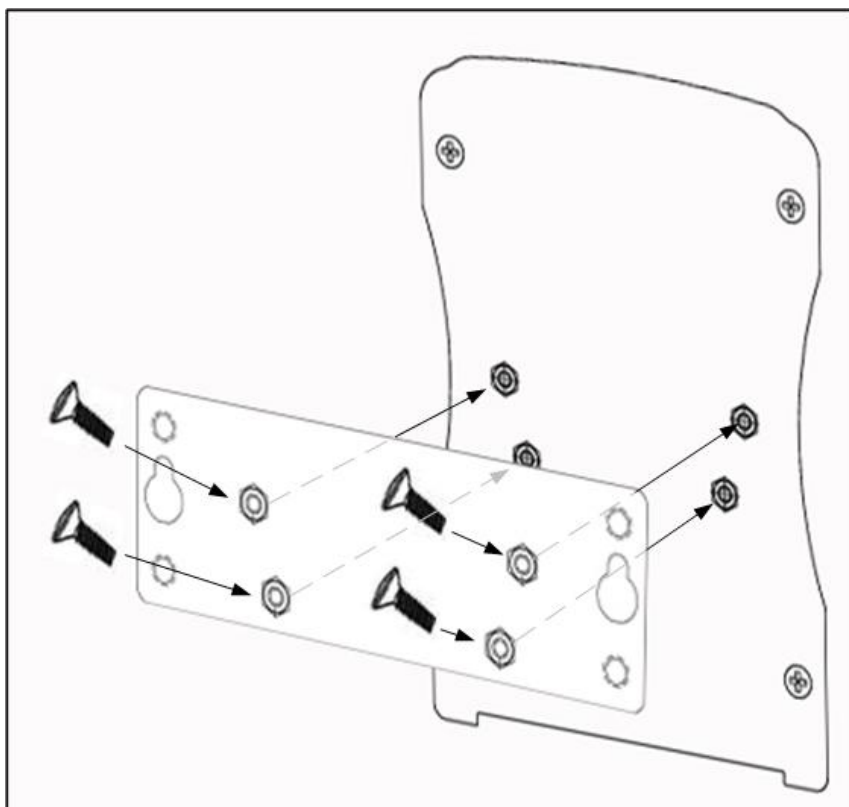

3 Preparation for Management

JetNet 5010G series Industrial Managed Switch provides both in-band and out-band configuration methods. You can configure the switch via RS232 console cable if you don't attach your admin PC to your network, or if you lose network connection to your JetNet 5010G. This is so-called out-band management. It wouldn't be affected by network performance.

The in-band management means you can remotely manage the switch via the network. You can choose Telnet or Web-based management. You just need to know the device's IP address and you can remotely connect to its embedded HTTP web pages or Telnet console.

Following topics are covered in this chapter:

3.1 Preparation for Serial Console

3.2 Preparation for Web Interface

3.3 Preparation for Telnet console

3.1 Preparation for Serial Console

In JetNet 5010G package, Korenix attached one RS-232 DB-9 to RJ-45 console cable. Please attach RS-232 DB-9 connector to your PC COM port, connect RJ-45 to the Console port of the JetNet 5010G. If you lose the cable, please follow the console cable PIN assignment to find one. (Refer to the appendix).

1. Go to Start -> Program -> Accessories -> Communication -> Hyper Terminal
2. Give a name to the new console connection.
3. Choose the COM name
4. Select correct serial settings. The serial settings of JetNet 5010G are as below:
Baud Rate: 9600 / Parity: None / Data Bit: 8 / Stop Bit: 1
5. After connected, you can see Switch login request.
6. Login the switch. The default username is "admin", password, "admin".

```
Booting...
          Sun Jan  1 00:00:00 UTC 2006

Switch login: admin
Password:

JetNet5010G (version 2.1.5-20080414-11:04:13).
Copyright 2006-2008 Korenix Technology Co., Ltd.

Switch>
```

3.2 Preparation for Web Interface

JetNet 5010G provides HTTP Web Interface and Secured HTTPS Web Interface for web management.

3.2.1 Web Interface

Korenix web management page is developed by JAVA. It allows you to use a standard web-browser such as Microsoft Internet Explorer, or Mozilla, to configure and interrogate the switch from anywhere on the network.

Before you attempt to use the embedded web interface to manage switch operation, verify that your JetNet 5010G Series Industrial Ethernet Switch is properly installed on your network and that every PC on this network can access the switch via the web browser.

1. Verify that your network interface card (NIC) is operational, and that your operating system supports TCP/IP protocol.
2. Wire DC power to the switch and connect your switch to your computer.
3. Make sure that the switch default IP address is 192.168.10.1.
4. Change your computer IP address to 192.168.10.2 or other IP address which is located in the 192.168.10.x (Network Mask: 255.255.255.0) subnet.
5. Switch to DOS command mode and ping 192.168.10.1 to verify a normal response time.

Launch the web browser and Login.

6. Launch the web browser (Internet Explorer or Mozilla Firefox) on the PC.
7. Type **http://192.168.10.1** (or the IP address of the switch). And then press **Enter**.
8. The login screen will appear next.
9. Key in user name and the password. Default user name and password are both **admin**.

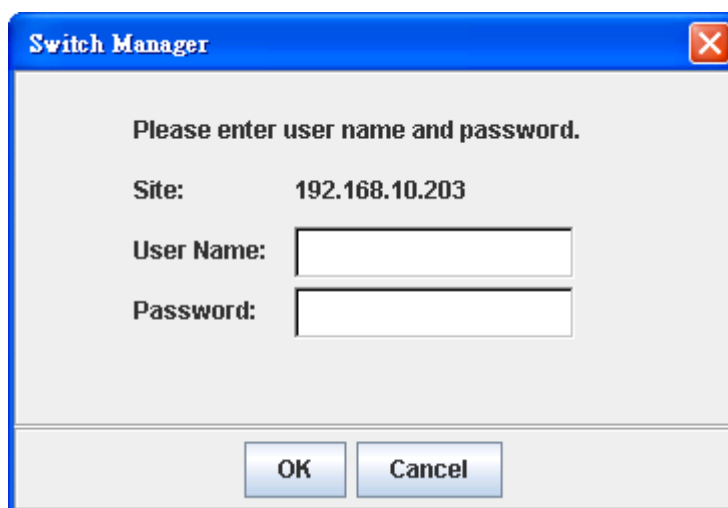

The image shows a dialog box titled "Switch Manager" with a blue title bar and a close button (X) in the top right corner. The main area is light gray and contains the text "Please enter user name and password." Below this, there are three labels: "Site:" followed by the value "192.168.10.203", "User Name:" followed by an empty text input field, and "Password:" followed by an empty password input field. At the bottom of the dialog, there are two buttons: "OK" and "Cancel".

Click on **Enter** or **OK**. Welcome page of the web-based management interface will then appear.

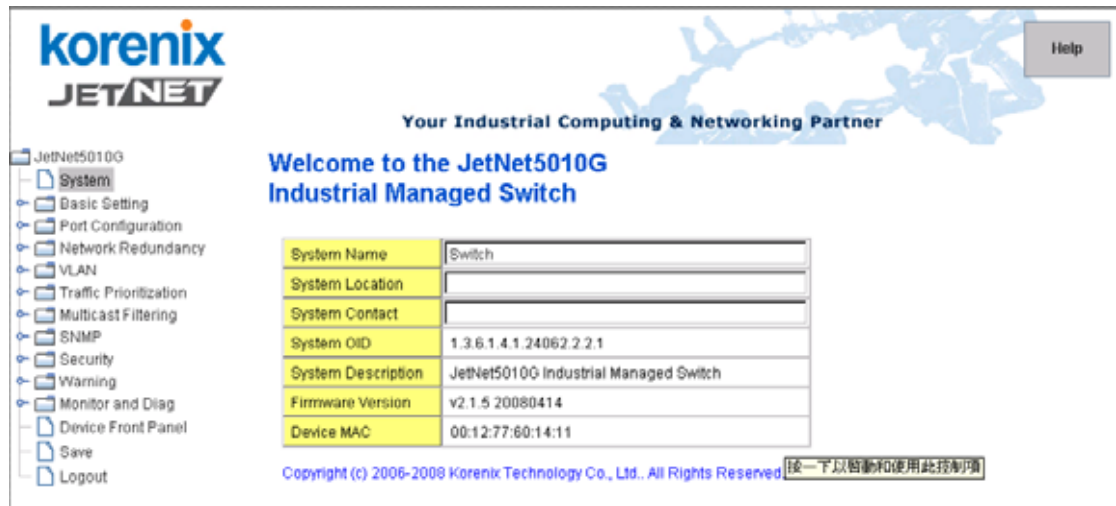

Once you enter the web-based management interface, you can freely change the JetNet's IP address to fit your network environment.

Note 1: IE 5.0 or later versions do not allow Java applets to open sockets by default. Users have to directly modify the browser settings to selectively enable Java applets to use network ports.

Note 2: The Web UI connection session of JetNet 5010G will be logged out automatically if you don't give any input after 30 seconds. After logged out, you should re-login and key in correct user name and password again.

3.2.2 Secured Web Interface

Korenix web management page also provides secured management HTTPS login. All the configuration commands will be secured and will be hard for the hackers to sniff the login password and configuration commands.

Launch the web browser and Login.

1. Launch the web browser (Internet Explorer or Mozilla Firefox) on the PC.
2. Type **https://192.168.10.1** (or the IP address of the switch). And then press **Enter**.
3. The popup screen will appear and request you to trust the secured HTTPS connection distributed by JetNet 5010G first. Press **Yes** to trust it.



4. The login screen will appear next.



5. Key in the user name and the password. The default user name and password is **admin**.
6. Click on **Enter** or **OK**. Welcome page of the web-based management interface will then appear.
7. Once you enter the web-based management interface, all the commands you see are the same as what you see by HTTP login.

3.3 Preparation for Telnet Console

3.3.1 Telnet

Korenix JetNet 5010G supports Telnet console. You can connect to the switch by Telnet and the command lines are the same as what you see by RS232 console port. Below are the steps to open Telnet connection to the switch.

1. Go to Start -> Run -> cmd. And then press **Enter**
2. Type the **Telnet 192.168.10.1** (or the IP address of the switch). And then press **Enter**

3.3.2 SSH (Secure Shell)

Korenix JetNet 5010G also support SSH console. You can remotely connect to the switch by command line interface. The SSH connection can secure all the configuration commands you sent to the switch.

SSH is a client/server architecture while JetNet 5010G is the SSH server. When you want to make SSH connection with the switch, you should download the SSH client tool first.

SSH Client

There are many free, sharewares, trials or charged SSH clients you can find on the internet. For example, PuTTY is a free and popular Telnet/SSH client. We'll use this tool to demonstrate how to login JetNet by SSH. Note: *PuTTY is copyright 1997-2006 Simon Tatham.*

Download PuTTY: <http://www.chiark.greenend.org.uk/~sgtatham/putty/download.html>

The copyright of **PuTTY**

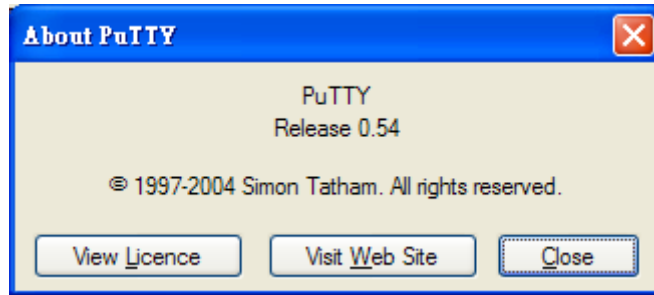

1. Open SSH Client/PuTTY

In the **Session** configuration, enter the **Host Name** (IP Address of your JetNet 5010G) and **Port number** (default = 22). Choose the “**SSH**” protocol. Then click on “**Open**” to start the SSH session console.

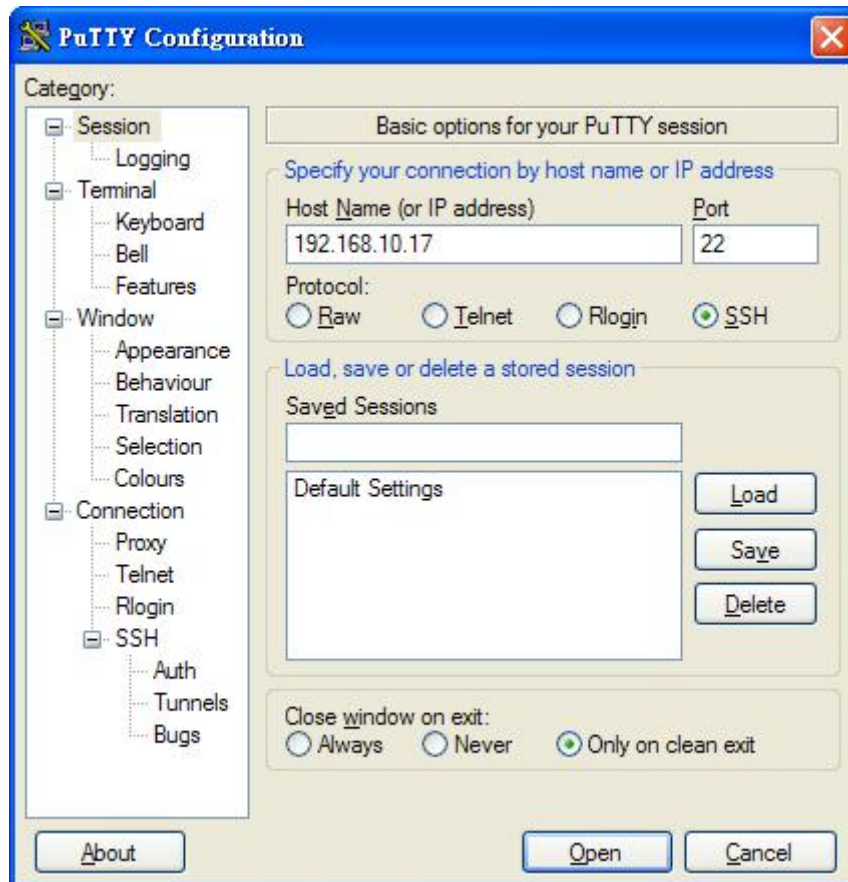

2. After click on **Open**, then you can see the cipher information in the popup screen. Press **Yes** to accept the Security Alert.

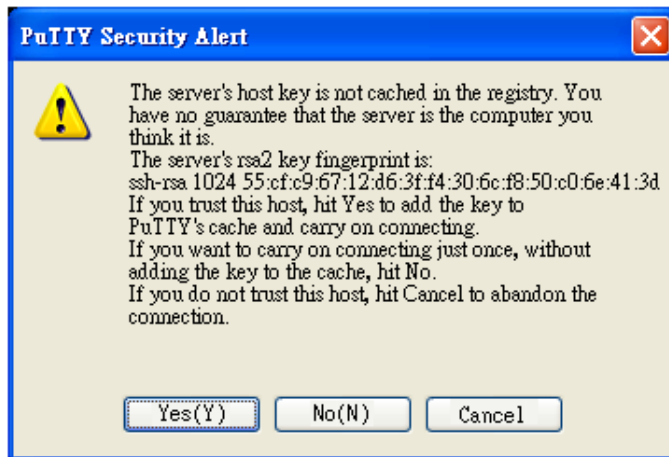

3. After few seconds, the SSH connection to JetNet 5010G is opened. You can see the login screen as the below figure.

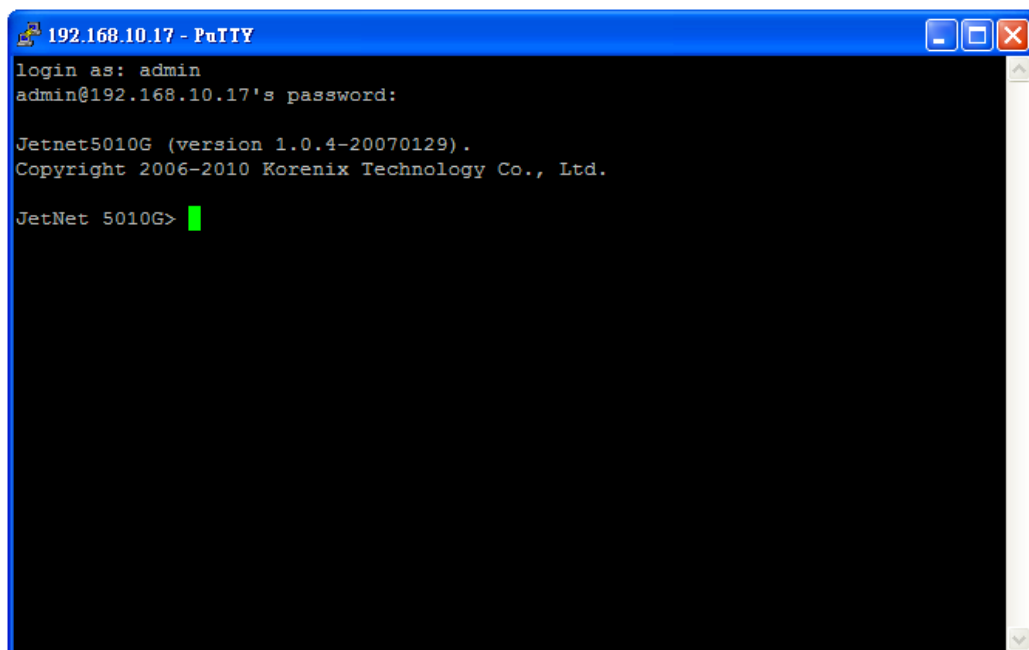

4. Type the Login Name and its Password. The default Login Name and Password are **admin / admin**.
5. All the commands you see in SSH are the same as the CLI commands you see via RS232 console. The next chapter will introduce in detail how to use command line to configure the switch.

4 Feature Configuration

This chapter explains how to configure JetNet 5010G software features. There are four ways to access the switch: Serial console, Telnet, Web browser and SNMP.

JetNet 5010G series Industrial Managed Switch provides both in-band and out-band configuration methods. You can configure the switch via RS232 console cable if you don't attach your admin PC to your network, or if you lose the network connection to your JetNet 5010G. This is so-called out-band management. It wouldn't be affected by the network performance.

The in-band management means you can remotely manage the switch via the network. You can choose Telnet or Web-based management. You just need to know the device's IP address. Then you can remotely connect to its embedded HTML web pages or Telnet console.

Korenix web management page is developed by JAVA. It allows you to use a standard web-browser such as Microsoft Internet Explorer, or Mozilla, to configure and interrogate the switch from anywhere on the network.

Note: IE 5.0 or later versions do not allow Java applets to open sockets by default. Users have to directly modify the browser settings to selectively enable Java applets to use network ports.

Following topics are covered in this chapter:

- 4.1 Command Line Interface (CLI) Introduction
- 4.2 Basic Setting
- 4.3 Port Configuration
- 4.4 Network Redundancy
- 4.5 VLAN
- 4.6 Traffic Prioritization
- 4.7 Multicast Filtering
- 4.8 SNMP
- 4.9 Security
- 4.10 Warning
- 4.11 Monitor and Diag
- 4.12 Device Front Panel
- 4.13 Save
- 4.14 Logout

4.1 Command Line Interface Introduction

The Command Line Interface (CLI) is the user interface to the switch's embedded software system. You can view the system information, show the status, configure the switch and receive a response back from the system by keying in a command.

There are some different command modes. Each command mode has its own access ability, available command lines and uses different command lines to enter and exit. These modes are User EXEC, Privileged EXEC, Global Configuration, (Port/VLAN) Interface Configuration modes.

User EXEC mode: As long as you login the switch by CLI. You are in the User EXEC mode. You can ping, telnet remote device, and show some basic information.

Type **enable** to enter next mode, **exit** to logout. **?** to see the command list

JN5010G>	
enable	Turn on privileged mode command
exit	Exit current mode and down to previous mode
list	Print command list
ping	Send echo messages
quit	Exit current mode and down to previous mode
show	Show running system information
telnet	Open a telnet connection
tracert	Trace route to destination

Privileged EXEC mode: Press enable in the User EXEC mode, then you can enter the Privileged EXEC mode. In this mode, the system allows you to view current configuration, reset default, reload switch, show system information, save configuration...and enter the global configuration mode.

Type **configure terminal** to enter next mode, **exit** to leave. **?** to see the command list

Switch#	
archive	manage archive files
clear	Reset functions
clock	Configure time-of-day clock
configure	Configuration from vty interface
copy	Copy from one file to another
debug	Debugging functions (see also 'undebug')
disable	Turn off privileged mode command
end	End current mode and change to enable mode
exit	Exit current mode and down to previous mode
list	Print command list
more	Display the contents of a file
no	Negate a command or set its defaults
ping	Send echo messages
quit	Exit current mode and down to previous mode
reboot	Reboot system
reload	copy a default-config file to replace the current one
show	Show running system information
telnet	Open a telnet connection
terminal	Set terminal line parameters
tracert	Trace route to destination
write	Write running configuration to memory, network, or terminal

Global Configuration Mode: Press **configure terminal** in privileged EXEC mode. You can then enter global configuration mode. In global configuration mode, you can configure all the features that the system provides you.

Type **interface IFNAME/VLAN** to enter interface configuration mode, **exit** to leave. **?** to see the command list.

Available command lists of global configuration mode.

Switch#	configure terminal
Switch(config)#	
access-list	Add an access list entry
administrator	Administrator account setting
arp	Set a static ARP entry
clock	Configure time-of-day clock
default	Set a command to its defaults
end	End current mode and change to enable mode
exit	Exit current mode and down to previous mode
grp	GARP VLAN Registration Protocol
hostname	Set system's network name
interface	Select an interface to configure
ip	IP information
lacp	Link Aggregation Control Protocol
list	Print command list
log	Logging control
mac	Global MAC configuration subcommands
mac-address-table	mac address table
mirror	Port mirroring
no	Negate a command or set its defaults
ntp	Configure NTP
password	Assign the terminal connection password
qos	Quality of Service (QoS)
relay	relay output type information
smtp-server	SMTP server configuration
snmp-server	SNMP server
spanning-tree	spanning tree algorithm
super-ring	super-ring protocol
trunk	Trunk group configuration
vlan	Virtual LAN
warning-event	Warning event selection
write-config	Specify config files to write to

(Port) Interface Configuration: Press **interface IFNAME** in global configuration mode. You can then enter interface configuration mode. In this mode, you can configure port settings.

The port interface name for fast Ethernet port 1 is fa1,... fast Ethernet 7 is fa7, gigabit Ethernet port 8 is gi8.. gigabit Ethernet port 10 is gi10. Type interface name accordingly when you want to enter certain interface configuration mode.

Type **exit** to leave.

Type **?** to see the command list

Available command lists of the global configuration mode.

Switch(config)# interface fa1	
Switch(config-if)#	
acceptable	Configure 802.1Q acceptable frame types of a port.
auto-negotiation	Enable auto-negotiation state of a given port
description	Interface specific description
duplex	Specify duplex mode of operation for a port
end	End current mode and change to enable mode
exit	Exit current mode and down to previous mode
flowcontrol	Set flow-control value for an interface
garp	General Attribute Registration Protocol
ingress	802.1Q ingress filtering features
lacp	Link Aggregation Control Protocol
list	Print command list
loopback	Specify loopback mode of operation for a port
mac	MAC interface commands
mdix	Enable mdix state of a given port
no	Negate a command or set its defaults
qos	Quality of Service (QoS)
quit	Exit current mode and down to previous mode
rate-limit	Rate limit configuration
shutdown	Shutdown the selected interface
spanning-tree	spanning-tree protocol
speed	Specify the speed of a Fast Ethernet port or a Gigabit
Ethernet port.	
switchport	Set switching mode characteristics

(VLAN) Interface Configuration: Press **interface VLAN VLAN-ID** in global configuration mode. You can then enter VLAN interface configuration mode. In this mode, you can configure the settings for the specific VLAN.

The VLAN interface name of VLAN 1 is VLAN 1, VLAN 2 is VLAN 2...

Type **exit** to leave the mode. Type **?** to see the available command list.

The command lists of the VLAN interface configuration mode.

Switch(config)# interface vlan 1	
Switch(config-if)#	
description	Interface specific description
end	End current mode and change to enable mode
exit	Exit current mode and down to previous mode
ip	Interface Internet Protocol config commands
list	Print command list
no	Negate a command or set its defaults
quit	Exit current mode and down to previous mode
shutdown	Shutdown the selected interface

Summary of the 5 command modes.

Command Mode	Main Function	Enter and Exit Method	Prompt
User EXEC	This is the first level of access. User can ping, telnet remote device, and show some basic information	Enter: Login successfully Exit: exit to logout. Next mode: Type enable to enter privileged EXEC mode.	Switch>
Privileged EXEC	In this mode, the system allows you to view current configuration, reset default, reload switch, show system information, save configuration...and enter global configuration mode.	Enter: Type enable in User EXEC mode. Exec: Type disable to exit to user EXEC mode. Type exit to logout Next Mode: Type configure terminal to enter global configuration command.	Switch#
Global configuration	In global configuration mode, you can configure all the features that the system provides you	Enter: Type configure terminal in privileged EXEC mode Exit: Type exit or end or press Ctrl-Z to exit. Next mode: Type interface IFNAME/ VLAN VID to enter interface configuration mode	Switch(config)#
Port Interface configuration	In this mode, you can configure port related settings.	Enter: Type interface IFNAME in global configuration mode. Exit: Type exit or Ctrl+Z to global configuration mode. Type end to privileged EXEC mode.	Switch(config-if)#
VLAN Interface Configuration	In this mode, you can configure settings for specific VLAN.	Enter: Type interface VLAN VID in global configuration mode. Exit: Type exit or Ctrl+Z to global configuration mode. Type end to privileged EXEC mode.	Switch(config-vlan)#

Here are some useful commands for you to see these available commands. Save your time in typing and avoid typing error.

? To see all the available commands in this mode. It helps you to see the next command you can/should type as well.

```
Switch(config)# interface (?)
IFNAME  Interface's name
vlan    Select a vlan to configure
```

(Character)? To see all the available commands starts from this character.

```
Switch(config)# a?
access-list  Add an access list entry
administrator Administrator account setting
arp          Set a static ARP entry
```

Tab This tab key helps you to input the command quicker. If there is only one available command in the next, clicking on tab key can help to finish typing soon.

```
Switch# co (tab) (tab)
Switch# configure terminal

Switch(config)# ac (tab)
Switch(config)# access-list
```

Ctrl+C To stop executing the unfinished command.

Ctrl+S To lock the screen of the terminal. You can't input any command.

Ctrl+Q To unlock the screen which is locked by Ctrl+S.

Ctrl+Z To exit configuration mode.

Alert message when multiple users want to configure the switch. If the administrator is in configuration mode, then the Web users can't change the settings. JetNet 5010G allows only one administrator to configure the switch at a time.

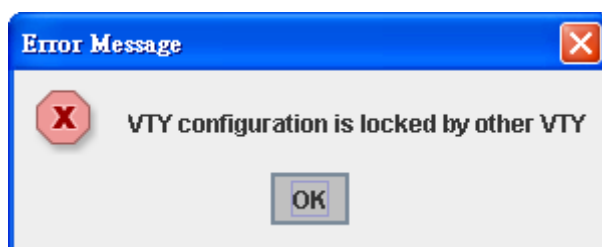

4.2 Basic Setting

The Basic Setting group provides you to configure switch information, IP address, User name/Password of the system. It also allows you to do firmware upgrade, backup and restore configuration, reload factory default, and reboot the system.

Following commands are included in this group:

4.2.1 Switch Setting

4.2.2 Admin Password

4.2.3 IP Configuration

4.2.4 Time Setting

4.2.5 DHCP Server

4.2.6 Backup and Restore

4.2.7 Firmware Upgrade

4.2.8 Factory Default

4.2.9 System Reboot

4.2.10 CLI Commands for Basic Setting

4.2.1 Switch Setting

You can assign System name, Location, Contact and view system information.

Figure 4.2.1.1 – Web UI of the Switch Setting



The screenshot displays the web interface for configuring a JetNet switch. On the left is a navigation tree with the following items: JetNet5010G, System, Basic Setting (selected), Admin Password, IP Configuration, Time Setting, DHCP Server, Backup and Restore, Firmware Upgrade, Factory Default, System Reboot, Port Configuration, Network Redundancy, VLAN, Traffic Prioritization, Multicast Filtering, SNMP, Security, Warning, Monitor and Diag, and Device Front Panel. The 'Switch Setting' sub-item under 'Basic Setting' is highlighted. On the right, the 'Switch Setting' configuration page is shown, featuring a table with the following fields:

System Name	JetNet 5010G
System Location	
System Contact	
System OID	1.3.6.1.2.24062.2.1.3
System Description	JetNet 5010G Industrial Managed Switch
Firmware Version	v1.2.20070620
Device MAC	00:12:77:ff:00:00

Below the table is an 'Apply' button.

System Name: You can assign a name to the device. The available characters you can input is 64. After you configure the name, CLI system will select the first 12 characters as the name in CLI system.

System Location: You can specify the switch's physical location here. The available characters you can input are 64.

System Contact: You can specify contact people here. You can type the name, mail address or other information of the administrator. The available characters you can input are 64.

System OID: The SNMP object ID of the switch. You can follow the path to find its private MIB in MIB browser. (**Note:** When you attempt to view private MIB, you should compile private MIB files into your MIB browser first.)

System Description: JetNet 5010G Industrial Management Ethernet Switch is the name of this product.

Firmware Version: Display the firmware version installed in this device.

MAC Address: Display unique hardware address (MAC address) assigned by the manufacturer.

Once you finish the configuration, click on **Apply** to apply your settings.

Note: Always remember to select **Save** to save your settings. Otherwise, the settings you made will be lost when the switch is powered off.

4.2.2 Admin Password

You can change the user name and the password here to enhance security

Figure 4.2.2.1 Web UI of the Admin Password



User name: You can key in new user name here. The default setting is **admin**.

Password: You can key in new password here. The default setting is **admin**.

Confirm Password: You need to type the new password again to confirm it.

Once you finish configuring the settings, click on **Apply** to apply your configuration.

Figure 4.2.2.2 Popup alert window for Incorrect Username.

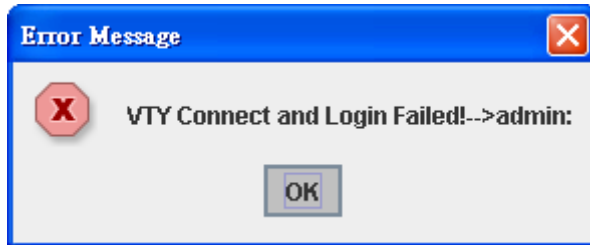

4.2.3 IP Configuration

This function allows users to configure the switch's IP address settings.

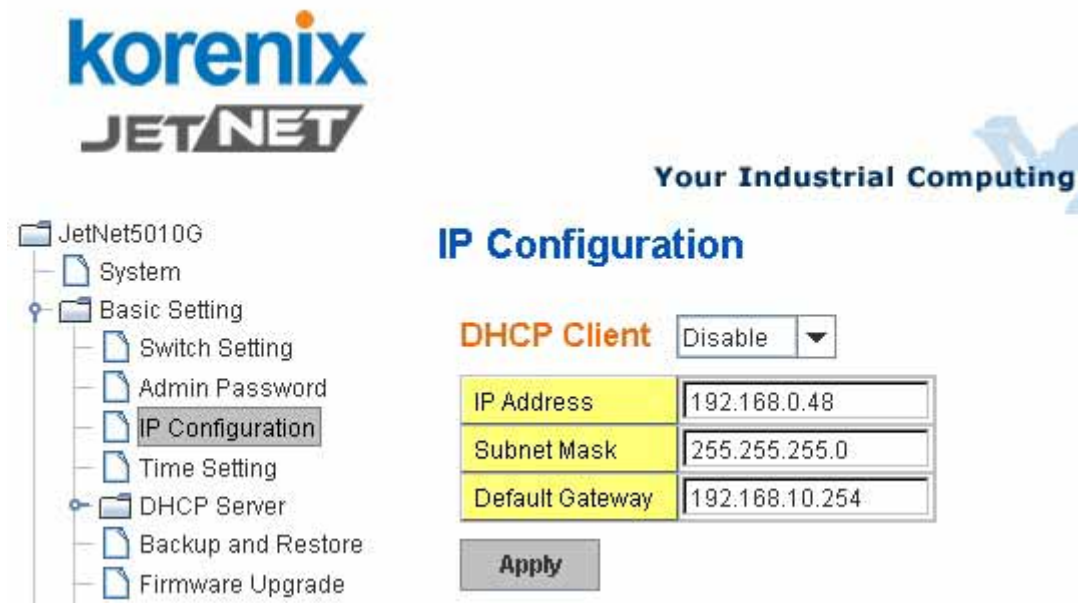

DHCP Client: You can select to **Enable** or **Disable** DHCP Client function. When DHCP Client function is enabled, an IP address will be assigned to the switch from the network's DHCP server. In this mode, the default IP address will therefore be replaced by the one assigned by DHCP server. If DHCP Client is disabled, then the IP address that you specified will be used instead.

IP Address: You can assign the IP address reserved by your network for your JetNet. If DHCP Client function is enabled, you don't need to assign an IP address to the JetNet, as it will be overwritten by DHCP server and shown here. The default IP is 192.168.10.1.

Subnet Mask: You can assign the subnet mask for the IP address here. If DHCP Client function is enabled, you don't need to assign the subnet mask. The default Subnet Mask is 255.255.255.0. **Note:** In the CLI, we use the enabled bit of the subnet mask to represent the number displayed in web UI. For example, 8 stands for 255.0.0.0; 16 stands for 255.255.0.0; 24 stands for 255.255.255.0.

Default Gateway: You can assign the gateway for the switch here. The default gateway is 192.168.10.254. **Note:** In CLI, we use 0.0.0.0/0 to represent for the default gateway.

Once you finish configuring the settings, click on **Apply** to apply your configuration.

4.2.4 Time Setting

Time Setting source allow user to set the time manually or through NTP server. Network Time Protocol (NTP) is used to synchronize computer clocks on the internet. You can configure NTP settings here to synchronize the clocks of several switches on the network. JetNet 5010G also provides Daylight Saving function.



Manual Setting: User can select Manual setting to change time as user wants. User also can click the button “Get Time from PC” to get PC’s time setting for switch.

NTP client: Select the Time Setting Source to NTP client can let device enable the NTP client service. NTP client will be automatically enabled if you change Time source to NTP Client. The system will send request packet to acquire current time from the NTP server you assigned.

Time Setting Source	NTP Client
NTP Client	Manual Setting
Primary Server Address	192.168.10.120
Secondary Server Address	192.168.10.121

Time-zone: Select the time zone where the switch is located. Following table lists the time zones for different locations for your reference. The default time zone is GMT Greenwich Mean Time.

```

Switch(config)# clock timezone
01 (GMT-12:00) Eniwetok, Kwajalein
02 (GMT-11:00) Midway Island, Samoa
03 (GMT-10:00) Hawaii
04 (GMT-09:00) Alaska
05 (GMT-08:00) Pacific Time (US & Canada) , Tijuana
06 (GMT-07:00) Arizona
07 (GMT-07:00) Mountain Time (US & Canada)
08 (GMT-06:00) Central America
09 (GMT-06:00) Central Time (US & Canada)
10 (GMT-06:00) Mexico City
11 (GMT-06:00) Saskatchewan
12 (GMT-05:00) Bogota, Lima, Quito
13 (GMT-05:00) Eastern Time (US & Canada)
14 (GMT-05:00) Indiana (East)
15 (GMT-04:00) Atlantic Time (Canada)
16 (GMT-04:00) Caracas, La Paz
17 (GMT-04:00) Santiago
18 (GMT-03:00) Newfoundland
19 (GMT-03:00) Brasilia
20 (GMT-03:00) Buenos Aires, Georgetown
21 (GMT-03:00) Greenland
22 (GMT-02:00) Mid-Atlantic
23 (GMT-01:00) Azores
24 (GMT-01:00) Cape Verde Is.
25 (GMT) Casablanca, Monrovia
26 (GMT) Greenwich Mean Time: Dublin, Edinburgh, Lisbon, London
27 (GMT+01:00) Amsterdam, Berlin, Bern, Rome, Stockholm, Vienna
28 (GMT+01:00) Belgrade, Bratislava, Budapest, Ljubljana, Prague
29 (GMT+01:00) Brussels, Copenhagen, Madrid, Paris
30 (GMT+01:00) Sarajevo, Skopje, Sofija, Vilnius, Warsaw, Zagreb
31 (GMT+01:00) West Central Africa
32 (GMT+02:00) Athens, Istanbul, Minsk
33 (GMT+02:00) Bucharest
34 (GMT+02:00) Cairo
35 (GMT+02:00) Harare, Pretoria
36 (GMT+02:00) Helsinki, Riga, Tallinn
37 (GMT+02:00) Jerusalem
38 (GMT+03:00) Baghdad
39 (GMT+03:00) Kuwait, Riyadh
40 (GMT+03:00) Moscow, St. Petersburg, Volgograd
41 (GMT+03:00) Nairobi
42 (GMT+03:30) Tehran
43 (GMT+04:00) Abu Dhabi, Muscat
44 (GMT+04:00) Baku, Tbilisi, Yerevan
45 (GMT+04:30) Kabul
46 (GMT+05:00) Ekaterinburg
47 (GMT+05:00) Islamabad, Karachi, Tashkent
48 (GMT+05:30) Calcutta, Chennai, Mumbai, New Delhi
49 (GMT+05:45) Kathmandu
50 (GMT+06:00) Almaty, Novosibirsk
51 (GMT+06:00) Astana, Dhaka
52 (GMT+06:00) Sri Jayawardenepura
53 (GMT+06:30) Rangoon
54 (GMT+07:00) Bangkok, Hanoi, Jakarta
55 (GMT+07:00) Krasnoyarsk

```

- 56 (GMT+08:00) Beijing, Chongqing, Hong Kong, Urumqi
- 57 (GMT+08:00) Irkutsk, Ulaan Bataar
- 58 (GMT+08:00) Kuala Lumpur, Singapore
- 59 (GMT+08:00) Perth
- 60 (GMT+08:00) Taipei
- 61 (GMT+09:00) Osaka, Sapporo, Tokyo
- 62 (GMT+09:00) Seoul
- 63 (GMT+09:00) Yakutsk
- 64 (GMT+09:30) Adelaide
- 65 (GMT+09:30) Darwin
- 66 (GMT+10:00) Brisbane
- 67 (GMT+10:00) Canberra, Melbourne, Sydney
- 68 (GMT+10:00) Guam, Port Moresby
- 69 (GMT+10:00) Hobart
- 70 (GMT+10:00) Vladivostok
- 71 (GMT+11:00) Magadan, Solomon Is., New Caledonia
- 72 (GMT+12:00) Auckland, Wellington
- 73 (GMT+12:00) Fiji, Kamchatka, Marshall Is.
- 74 (GMT+13:00) Nuku'alofa

Daylight Saving Time: Set when Enable Daylight Saving Time start and end, during the Daylight Saving Time, the device's time is one hour earlier than the actual time.

Once you finish your configuration, click on **Apply** to apply your configuration.

4.2.5 DHCP Server

You can select to **Enable** or **Disable** DHCP Server function. *JetNet 5010G* will assign a new IP address to link partners.

DHCP Server configuration

After selecting to enable DHCP Server function, type in the Network IP address for the DHCP server IP pool, Subnet Mask, Default Gateway address and Lease Time for client.

DHCP Server

DHCP Server Configuration

Network	192.168.10.0
Subnet Mask	255.255.255.0
Default Gateway	192.168.10.1
Lease Time(s)	604800

Apply

Once you have finished the configuration, click **Apply** to apply your configuration

Excluded Address:

You can type a specific address into the **IP Address field** for the DHCP server reserved IP address.

The IP address that is listed in the **Excluded Address List Table** will not be assigned to the network device. Add or remove an IP address from the **Excluded Address List** by clicking **Add** or **Remove**.

Excluded Address

IP Address	192.168.10.200
------------	----------------

Add

Excluded Address List

Index	IP Address
1	192.168.10.200

Remove

Manual Binding: *JetNet 5010G* provides a MAC address and IP address binding and removing function. You can type in the specified IP and MAC address, then click **Add** to add a new MAC&IP address binding rule for a specified link partner, like PLC or any device without **DHCP client** function. To remove from the binding list, just select the rule to remove and click **Remove**.

Manual Binding

IP Address	
MAC Address	

Add

Manual Binding List

Index	IP Address	MAC Address
-------	------------	-------------

Remove

DHCP Leased Entries: *JetNet 5010G* provides an assigned IP address list for user check. It will show the MAC and IP address that was assigned by *JetNet 5010G*. Click the **Reload** button to refresh the listing.

DHCP Leased Entries

Index	Binding	IP Address	MAC Address	Lease Time(s)
1	Auto	192.168.0.3	0012.77ff.0530	604785

Reload

4.2.6 Backup and Restore

With Backup command, you can save current configuration file saved in the switch's flash to admin PC or TFTP server. This will allow you to go to **Restore** command later to restore the configuration file back to the switch. Before you restore the configuration file, you must place the backup configuration file in the PC or TFTP server. The switch will then download this file back to the flash.

There are 2 modes for users to backup/restore the configuration file, Local File mode and TFTP Server mode.

Local File mode: In this mode, the switch acts as the file server. Users can browse the target folder and then type the file name to backup the configuration. Users can also browse the target folder and select existed configuration file to restore the configuration back to the switch. This mode is only provided by Web UI while CLI is not supported.

TFTP Server mode: In this mode, the switch acts as TFTP client. Before you do so, make sure that your TFTP server is ready. Then please type the IP address of TFTP Server and Backup configuration file name. This mode can be used in both CLI and Web UI.

TFTP Server IP Address: You need to key in the IP address of your TFTP Server here.

Backup/Restore File Name: Please type the correct file name of the configuration file..

Configuration File: The configuration file of the switch is a pure text file. You can open it by word/txt read file. You can also modify the file, add/remove the configuration settings, and then restore back to the switch.

Startup Configuration File: After you saved the running-config to flash, the new settings will be kept and work after power cycle. You can use `show startup-config` to view it in CLI. The Backup command can only backup such configuration file to your PC or TFTP server.

Technical Tip:

Default Configuration File: The switch provides the default configuration file in the system. You can use Reset button, Reload command to reset the system.

Running Configuration File: The switch's CLI allows you to view the latest settings running by the system. The information shown here is the settings you set up but haven't saved to flash. The settings not yet saved to flash will not work after power recycle. You can use `show running-config` to view it in CLI.

Figure 4.2.5.1 Main UI of Backup & Restore



Figure 4.2.5.2 Backup/Restore Configuration - Local File mode.

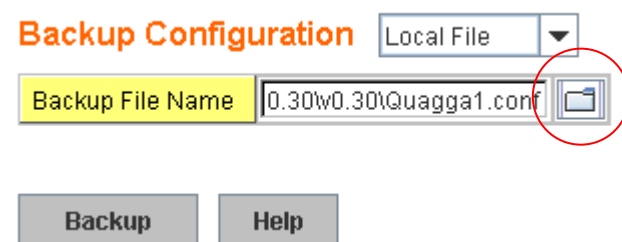

 Click on Folder icon to select the target file you want to backup/restore.

Note that the folders of the path to the target file do not allow you to input space key.

Figure 4.2.5.3 Backup/Restore Configuration - TFTP Server mode

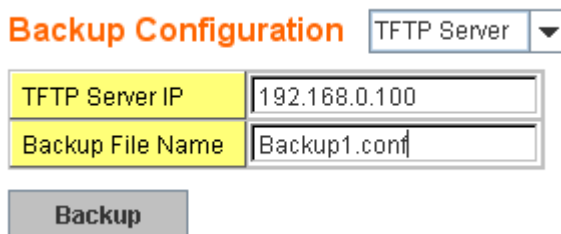

Type the IP address of TFTP Server IP. Then click on **Backup/Restore**.

Note: point to the wrong file will cause the entire configuration missed

4.2.7 Firmware Upgrade

In this section, you can update the latest firmware for your switch. Korenix provides the latest firmware in Korenix Web site. The new firmware may include new features, bug fixes or other software changes. We'll also provide the release notes for the update as well. For technical viewpoint, we suggest you use the latest firmware before installing the switch to the customer site.

Note that the system will be automatically rebooted after you finished upgrading new firmware. Please remind the attached users before you do this.

Figure 4.2.5.1 Main UI of Firmware Upgrade



There are 2 modes for users to backup/restore the configuration file, Local File mode and TFTP Server mode.

Local File mode: In this mode, the switch acts as the file server. Users can browse the target folder and then type the file name to backup the configuration. Users also can browse the target folder and select the existed configuration file to restore the configuration back to the switch. This mode is only provided by Web UI while CLI is not supported.

TFTP Server mode: In this mode, the switch acts as the TFTP client. Before you do so, make sure that your TFTP server is ready. And then please type the IP address of TFTP Server IP address. This mode can be used in both CLI and Web UI.

TFTP Server IP Address: You need to key in the IP address of your TFTP Server here.

Firmware File Name: The file name of the new firmware.

The UI also shows you the current firmware version and built date of current firmware. Please check the version number after the switch is rebooted.

Figure 4.2.6.2 Firmware Upgrade - Local File mode.

Firmware Upgrade

System Firmware Version: v1.2
System Firmware Date: 20070620

Firmware Upgrade Local File ▼

Firmware File Name 

Note: When firmware upgrade is finished, the switch will restart automatically.

Upgrade



Click on Folder icon to select the target firmware file you want to upgrade.

Figure 4.2.6.3 Firmware Upgrade – TFTP Server mode.

Firmware Upgrade

System Firmware Version: v1.2
System Firmware Date: 20070620

Firmware Upgrade TFTP Server ▼

TFTP Server IP

Firmware File Name

Note: When firmware upgrade is finished, the switch will restart automatically.

Upgrade

Type the IP address of TFTP Server and Firmware File Name. Then click on **Upgrade** to start the process.

After finishing transmitting the firmware, the system will copy the firmware file and replace the firmware in the flash. The CLI show until the process is finished.

4.2.8 Factory Default

In this section, you can reset all the configurations of the switch to default setting. Click on **Reset** the system will then reset all configurations to default setting. The system will show you popup message window after finishing this command. Default setting will work after rebooting the switch.

Figure 4.2.7.1 The main screen of the Reset to Default

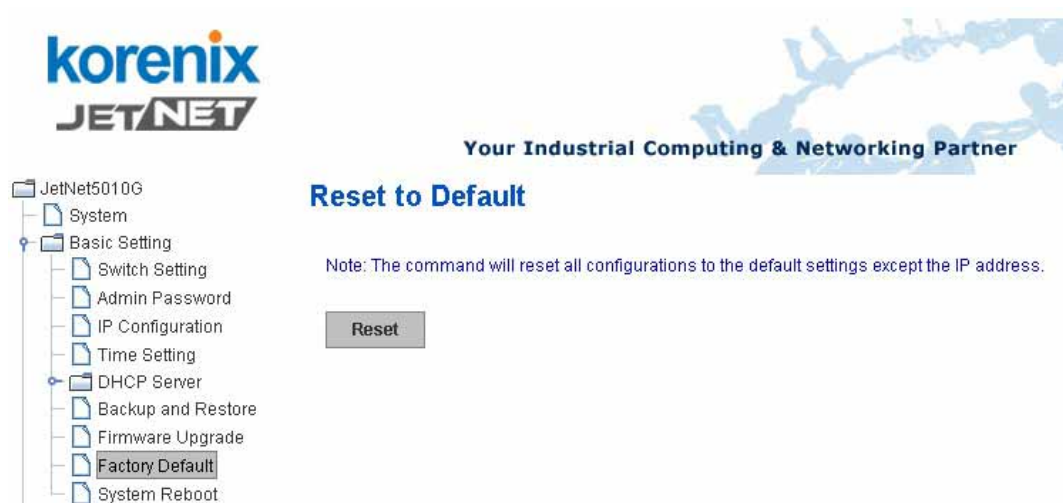

Figure 4.2.7.2 Popup alert screen to confirm the command. Click on **Yes** to start it.

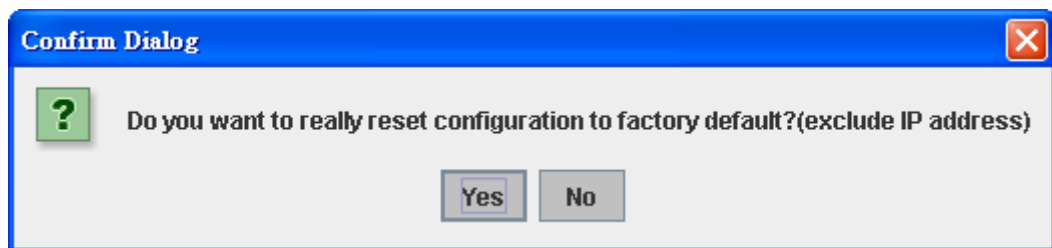
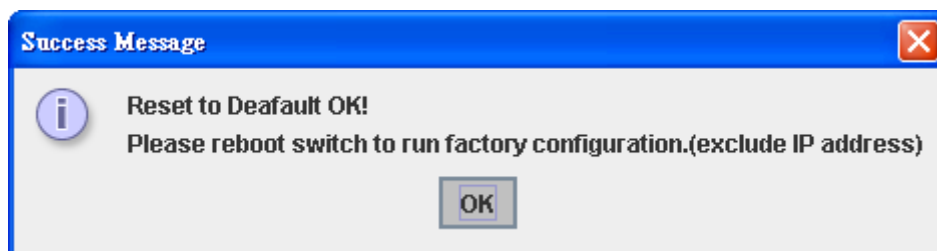

Figure 4.2.7.2 Popup message screen to show you that have done the command. Click on **OK** to close the screen. Then please go to **Reboot** page to reboot the switch.



Click on **OK**. The system will then auto reboot the device.

Note: If you already configured the IP of your device to other IP address, when you use this command by CLI and Web UI, our software will not reset the IP address to default IP. The system will remain the IP address so that you can still connect the switch via the network.

4.2.9 System Reboot

System Reboot allows you to reboot the device. Some of the feature changes require you to reboot the system. Click on **Reboot** to reboot your device.

Note: Remember to click on **Save** button to save your settings. Otherwise, the settings you made will be gone when the switch is powered off.

Figure 4.2.8.1 Main screen for Rebooting



Figure 4.2.8.2 Pop-up alert screen to request confirmation. Click on **Yes**. Then the switch will be rebooted immediately.

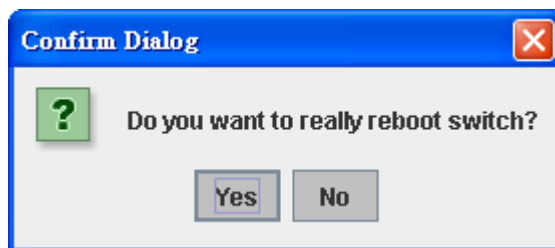
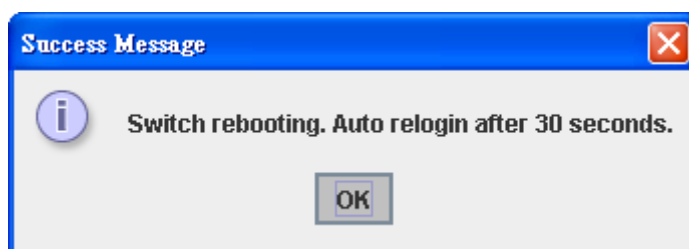

Figure 4.2.8.3 Pop-up message screen appears when rebooting the switch..



4.2.10 CLI Commands for Basic Setting

Feature	Command Line
Switch Setting	
System Name	Switch(config)# hostname WORD Network name of this system Switch(config)# hostname JN5010G SWITCH(config)#

System Location	SWITCH(config)# snmp-server location Taipei
System Contact	SWITCH(config)# snmp-server contact korecare@korenix.com
Display	SWITCH# show snmp-server name SWITCH SWITCH# show snmp-server location Taipei SWITCH# show snmp-server contact korecare@korenix.com SWITCH> show version 0.31-20061218 Switch# show hardware mac MAC Address : 00:12:77:FF:01:B0
Admin Password	
User Name and Password	SWITCH(config)# administrator NAME Administrator account name SWITCH(config)# administrator orwell PASSWORD Administrator account password SWITCH(config)# administrator orwell orwell Change administrator account orwell and password orwell success.
Display	SWITCH# show administrator Administrator account information name: orwell password: orwell
IP Configuration	
IP Address/Mask (192.168.10.8, 255.255.255.0)	SWITCH(config)# int vlan 1 SWITCH(config-if)# ip address dhcp SWITCH(config-if)# ip address 192.168.10.8/24 SWITCH(config-if)# ip dhcp client SWITCH(config-if)# ip dhcp client renew
Gateway	SWITCH(config)# ip route 0.0.0.0/0 192.168.10.254/24
Remove Gateway	SWITCH(config)# no ip route 0.0.0.0/0 192.168.10.254/24
Display	SWITCH# show running-config ! interface vlan1 ip address 192.168.10.8/24 no shutdown ! ip route 0.0.0.0/0 192.168.10.254/24 !
Time Setting	
NTP Server	SWITCH(config)# ntp peer enable disable primary secondary SWITCH(config)# ntp peer primary IPADDR

	SWITCH(config)# ntp peer primary 192.168.10.120
Time Zone	SWITCH(config)# clock timezone 26 Sun Jan 1 04:13:24 2006 (GMT) Greenwich Mean Time: Dublin, Edinburgh, Lisbon, London Note: By typing clock timezone ?, you can see the timezone list. Then choose the number of the timezone you want to select.
Display	SWITCH# sh ntp associations Network time protocol Status : Disabled Primary peer : N/A Secondary peer : N/A SWITCH# show clock Sun Jan 1 04:14:19 2006 (GMT) Greenwich Mean Time: Dublin, Edinburgh, Lisbon, London SWITCH# show clock timezone clock timezone (26) (GMT) Greenwich Mean Time: Dublin, Edinburgh, Lisbon, London
Backup and Restore	
Backup Startup Configuration file	Switch# copy startup-config tftp: 192.168.10.33/default.conf Writing Configuration [OK] Note 1: To backup the latest startup configuration file, you should save current settings to flash first. You can refer to 4.12 to see how to save settings to the flash. Note 2: 192.168.10.33 is the TFTP server's IP and default.conf is name of the configuration file. Your environment may use different IP addresses or different file name. Please type target TFTP server IP or file name in this command.
Restore Configuration	Switch# copy tftp: 192.168.10.33/default.conf startup-config
Show Startup Configuration	Switch# show startup-config
Show Running Configuration	Switch# show running-config
Firmware Upgrade	
Firmware Upgrade	Switch# archive download-sw /overwrite tftp 192.168.10.33 JN5010G.bin Firmware upgrading, don't turn off the switch! Tftping file JN5010G.bin Firmware upgrading Firmware upgrade success!! Rebooting.....
Factory Default	
Factory Default	Switch# reload default-config file Reload OK! Switch# reboot
System Reboot	
Reboot	Switch# reboot

4.3 Port Configuration

Port Configuration group enables you to enable/disable port state, or configure port auto-negotiation, speed, and duplex, flow control, rate limit control and port aggregation settings. It also allows you to view port status and aggregation information.

Following commands are included in this group:

4.3.1 Port Control

4.3.2 Port Status

4.3.3 Rate Control

4.3.4 Port Trunking

4.3.5 Command Lines for Port Configuration

4.3.1 Port Control

Port Control commands allow you to enable/disable port state, or configure the port auto-negotiation, speed, duplex and flow control.

Port Configuration

Port	State	Speed/Duplex	Flow Control
1	Enable	AutoNegotiation	Disable
2	Enable	AutoNegotiation	Disable
3	Enable	AutoNegotiation	Disable
4	Enable	AutoNegotiation	Disable
5	Enable	AutoNegotiation	Disable
6	Enable	AutoNegotiation	Disable
7	Enable	AutoNegotiation	Disable
8	Enable	AutoNegotiation	Disable
9	Enable	AutoNegotiation	Disable
10	Enable	AutoNegotiation	Disable

Apply

Select the port you want to configure and make changes to the port.

In **State** column, you can enable or disable the state of this port. Once you disable, the port stop to link to the other end and stop to forward any traffic. The default setting is Enable which means all the ports are workable when you receive the device.

In **Speed/Duplex** column, you can configure port speed and duplex mode of this port. Below are the selections you can choose:

Fast Ethernet Port 1~7 (fa1~fa7) : AutoNegotiation, 10M Full Duplex(10 Full), 10M Half Duplex(10 Half), 100M Full Duplex(100 Full) and 100M Half Duplex(100 Half).

Gigabit Ethernet Port 8~10: (gi8~gi10) : AutoNegotiation, 10M Full Duplex(10 Full), 10M

Half Duplex(10 Half), 100M Full Duplex(100 Full), 100M Half Duplex(100 Half), 1000M Full Duplex(1000 Full), 1000M Half Duplex(1000 Half).

The default mode is Auto Negotiation mode.

In **Flow Control** column, “Symmetric” means that you need to activate the flow control function of the remote network device in order to let the flow control of that corresponding port on the switch to work. “Disable” means that you don’t need to activate the flow control function of the remote network device, as the flow control of that corresponding port on the switch will work anyway.

Once you finish configuring the settings, click on **Apply** to save the configuration.

Technical Tips: If both ends are not at the same speed, they can’t link with each other. If both ends are not in the same duplex mode, they will be connected by half mode.

4.3.2 Port Status

Port Status shows you current port status.

Port	Type	Link	State	Speed/Duplex	Flow Control	SFP Vendor	Wavelength	Distance
1	100BASE	Down	Enable	--	Disable	--	--	--
2	100BASE	Down	Enable	--	Disable	--	--	--
3	100BASE	Down	Enable	--	Disable	--	--	--
4	100BASE	Down	Enable	--	Disable	--	--	--
5	100BASE-TX	Up	Enable	100 Full	Disable	--	--	--
6	100BASE-TX	Up	Enable	100 Full	Disable	--	--	--
7	100BASE	Down	Enable	--	Disable	--	--	--
8	100BASE	Down	Enable	--	Disable	--	--	--
9	100BASE-TX	Up	Enable	100 Full	Disable	--	--	--
10	100BASE	Down	Enable	--	Disable	--	--	--

The description of the columns is as below:

Port: Port interface number.

Type: 100TX -> Fast Ethernet port. 1000TX -> Gigabit Ethernet port.

Link: Link status. Up -> Link UP. Down -> Link Down.

State: Enable -> State is enabled. Disable -> The port is disable/shutdown.

Speed/Duplex: Current working status of the port.

Flow Control: The state of the flow control.

SFP Vendor: Vendor name of the SFP transceiver you plugged.

Wavelength: The wave length of the SFP transceiver you plugged.

Distance: The distance of the SFP transceiver you plugged.

Note: Most of the SFP transceivers provide vendor information which allows your switch to read it. The UI can display vendor name, wave length and distance of all Korenix SFP transceiver family. If you see Unknown info, it may mean that the vendor doesn’t provide their information or that the information of their transceiver can’t be read.

4.3.3 Rate Control



Your Industrial Computing & Networking Partner

- JetNet5010G
 - System
 - Basic Setting
 - Port Configuration
 - Port Control
 - Port Status
 - Rate Control**
 - Port Trunking
 - Network Redundancy
 - VLAN
 - Traffic Prioritization
 - Multicast Filtering
 - SNMP
 - Security
 - Warning
 - Monitor and Diag
 - Device Front Panel
 - Save
 - Logout

Rate Control

Limit Packet Type and Rate

Port	Ingress Rule		Egress Rule	
	Packet Type	Rate(Mbps)	Packet Type	Rate(Mbps)
1	Broadcast Only	8	All	0
2	Broadcast Only	8	All	0
3	Broadcast Only	8	All	0
4	Broadcast Only	8	All	0
5	Broadcast Only	8	All	0
6	Broadcast Only	8	All	0
7	Broadcast Only	8	All	0
8	Broadcast Only	8	All	0
9	Broadcast Only	8	All	0
10	Broadcast Only	8	All	0

Apply

Rate limiting is a form of flow control used to enforce a strict bandwidth limit at a port. You can program separate transmit (Egress Rule) and receive (Ingress Rule) rate limits at each port, and even apply the limit to certain packet types as described below.

Packet type: You can select the packet type that you want to filter. The packet types of the Ingress Rule listed here include **Broadcast Only / Broadcast and multicast / Broadcast, Multicast and Unknown Unicast** or **All**. The packet types of the Egress Rule (outgoing) only support **all** packet types.

Rate: This column allows you to manually assign the limit rate of the port. Valid values are from 1Mbps-100Mbps for fast Ethernet ports and gigabit Ethernet ports. The step of the rate is 1 Mbps. Default value of Ingress Rule is “8” Mbps; default value of Egress Rule is 0 Mbps. 0 stands for disabling the rate control for the port.

Click on **Apply** to apply the configuration.

4.3.4 Port Trunking

Port Trunking configuration allows you to group multiple Ethernet ports in parallel to increase link bandwidth. The aggregated ports can be viewed as one physical port so that the bandwidth is higher than merely one single Ethernet port. The member ports of the same trunk group can balance the loading and backup for each other. Port Trunking feature is usually used when you need higher bandwidth for backbone network. This is an inexpensive way for you to transfer more data.

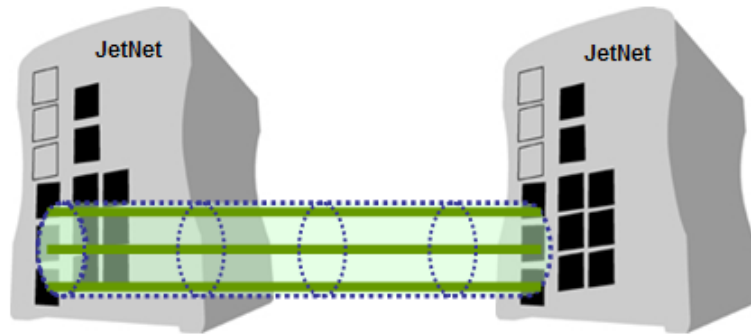

There are some different descriptions for the port trunking. Different manufacturers may use different descriptions for their products, like Link Aggregation Group (LAG), Link Aggregation Control Protocol, Ethernet Trunk, Ether Channel...etc. Most of the implementations now conform to IEEE standard, 802.3ad.

The aggregated ports can interconnect to the other switch which also supports Port Trunking. Korenix Supports 2 types of port trunking. One is Static Trunk, the other is 802.3ad. When the other end uses 802.3ad LACP, you **should** assign 802.3ad LACP to the trunk. When the other end uses non-802.3ad, you can then use Static Trunk.

There are 2 configuration pages, Aggregation Setting and Aggregation Status.

Aggregation Setting



Your Industrial Computing & Network

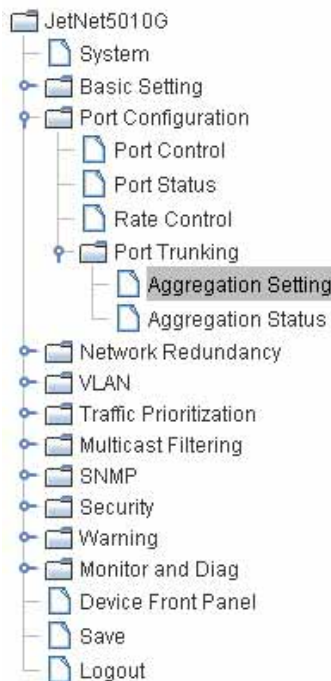

Port Trunk - Aggregation Setting

Port	Group ID	Type
1	Trunk 1	Static
2	Trunk 1	Static
3	Trunk 2	802.3ad LACP
4	Trunk 2	802.3ad LACP
5	None	Static
6	None	Static
7	None	Static
8	None	Static
9	None	Static
10	None	Static

Note: The port parameters of the trunk members should be the same.

Apply

Trunk Size: The switch can support up to 5 trunk groups. Each trunk group can support up to 8 member ports. Since the member ports should use same speed/duplex, max groups for 100M ports would be 7, and 3 for gigabit ports.

Group ID: Group ID is the ID for the port trunking group. Ports with same group ID are in the same group.

Type: Static and 802.3ad LACP. Each Trunk Group can only support Static or 802.3ad LACP. Choose the type you need here.

Aggregation Status

This page shows the status of port aggregation. Once the aggregation ports are negotiated well, you will see following status.

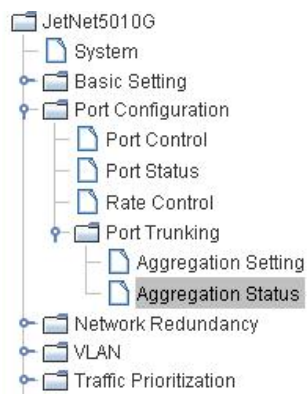

Port Trunk - Aggregation Information

Group ID	Type	Group Member		
		Aggregated	Individual	Link Down
Trunk 1	LACP		7	5,6
Trunk 2	LACP	8,9,10		
Trunk 3				
Trunk 4				
Trunk 5				

Group ID: Display Trunk 1 to Trunk 5 set up in Aggregation Setting.

Type: Static or LACP set up in Aggregation Setting.

Aggregated: When LACP links well, you can see the member ports in Aggregated column.

Individual: When LACP is enabled, member ports of LACP group which are not connected to correct LACP member ports will be displayed in the Individual column.

Link Down: When LACP is enabled, member ports of LACP group which are not linked up will be displayed in the Link Down column.

4.3.5 Command Lines for Port Configuration

Feature	Command Line
Port Control	
Port Control – State	<p>Switch(config-if)# shutdown -> Disable port state Port1 Link Change to DOWN interface fastethernet1 is shutdown now.</p> <p>Switch(config-if)# no shutdown -> Enable port state Port1 Link Change to DOWN Port1 Link Change to UP interface fastethernet1 is up now. Switch(config-if)# Port1 Link Change to UP</p>

Port Control – Auto Negotiation	Switch(config)# interface fa1 Switch(config-if)# auto-negotiation Auto-negotiation of port 1 is enabled!
Port Control – Force Speed/Duplex	Switch(config-if)# speed 100 Port1 Link Change to DOWN set the speed mode ok! Switch(config-if)# Port1 Link Change to UP Switch(config-if)# duplex full Port1 Link Change to DOWN set the duplex mode ok! Switch(config-if)# Port1 Link Change to UP
Port Control – Flow Control	Switch(config-if)# flowcontrol on Flowcontrol on for port 1 set ok! Switch(config-if)# flowcontrol off Flowcontrol off for port 1 set ok!
Port Status	
Port Status	Switch# show interface fa1 Interface fastethernet1 Administrative Status : Enable Operating Status : Connected Duplex : Full Speed : 100 Flow Control :off Default Port VLAN ID: 1 Ingress Filtering : Disabled Acceptable Frame Type : All Port Security : Disabled Auto Negotiation : Disable Loopback Mode : None STP Status: forwarding Default CoS Value for untagged packets is 0. Mdix mode is Disable. Medium mode is Copper. <i>Note: Administrative Status -> Port state of the port. Operating status -> Current status of the port. Duplex -> Duplex mode of the port. Speed -> Speed mode of the port. Flow control -> Flow Control status of the port.</i>
Rate Control	
Rate Control – Ingress or Egress	Switch(config-if)# rate-limit egress Outgoing packets ingress Incoming packets Note: To enable rate control, you should select the Ingress or Egress rule first; then assign the packet type and bandwidth.
Rate Control – Filter Packet Type	Switch(config-if)# rate-limit ingress mode all Limit all frames broadcast Limit Broadcast frames flooded-unicast Limit Broadcast, Multicast and flooded unicast frames multicast Limit Broadcast and Multicast frames

	Switch(config-if)# rate-limit ingress mode broadcast Set the ingress limit mode broadcast ok.																								
Rate Control - Bandwidth	Switch(config-if)# rate-limit ingress bandwidth <0-100> Limit in magabits per second (0 is no limit) Switch(config-if)# rate-limit ingress bandwidth 8 Set the ingress rate limit 8Mbps for Port 1.																								
Port Trunking																									
LACP	Switch(config)# lacp group 1 gi8-10 Group 1 based on LACP(802.3ad) is enabled! <i>Note: The interface list is fa1,fa3-5,gi8-10</i> Note: different speed port can't be aggregated together.																								
Static Trunk	Switch(config)# trunk group 2 fa6-7 Trunk group 2 enable ok!																								
Display - LACP	etNet 5010G# show lacp internal LACP group 1 internal information: <table border="1"> <thead> <tr> <th>LACP Port</th> <th>Admin</th> <th>Oper</th> <th>Port</th> </tr> <tr> <th>Port</th> <th>Priority</th> <th>Key</th> <th>Key</th> <th>State</th> </tr> </thead> <tbody> <tr> <td>8</td> <td>1</td> <td>8</td> <td>8</td> <td>0x45</td> </tr> <tr> <td>9</td> <td>1</td> <td>9</td> <td>9</td> <td>0x45</td> </tr> <tr> <td>10</td> <td>1</td> <td>10</td> <td>10</td> <td>0x45</td> </tr> </tbody> </table> LACP group 2 is inactive LACP group 3 is inactive LACP group 4 is inactive	LACP Port	Admin	Oper	Port	Port	Priority	Key	Key	State	8	1	8	8	0x45	9	1	9	9	0x45	10	1	10	10	0x45
LACP Port	Admin	Oper	Port																						
Port	Priority	Key	Key	State																					
8	1	8	8	0x45																					
9	1	9	9	0x45																					
10	1	10	10	0x45																					
Display - Trunk	Switch# show trunk group 1 FLAGS: I -> Individual P -> In channel D -> Port Down Trunk Group GroupID Protocol Ports -----+-----+----- 1 LACP 8(D) 9(D) 10(D) Switch# show trunk group 2 FLAGS: I -> Individual P -> In channel D -> Port Down Trunk Group GroupID Protocol Ports -----+-----+----- 2 Static 6(D) 7(P) Switch#																								

4.4 Network Redundancy

It is critical for industrial applications that network remains non-stop. JetNet 5010G v2.1 firmware supports standard RSTP, Multiple Super Ring, Rapid Dual Homing and backward compatible with Legacy Super Ring Client modes.

Multiple Super Ring (MSR) technology is *Korenix's* 3rd generation Ring redundancy technology. This is patented and protected by *Korenix* and is used in countries all over the world. MSR ranks the fastest restore and failover time in the world, 0 ms for restore and about 5 milliseconds for failover for copper.

Advanced Rapid Dual Homing(RDH) technology also facilitates *JetNet 5010G* to connect with a core managed switch easily and conveniently. With RDH technology, you can also couple several Rapid Super Rings or RSTP cloud together, which is also known as Auto Ring Coupling.

To become backwards compatible with the Legacy Super Ring technology implemented in *JetNet 4000/4500* switches, *JetNet 5010G* also supports Super Ring Client mode. The Super Ring ports can pass through Super Ring control packets extremely well and works with Super Ring.

Besides *Korenix* ring technology, *JetNet 5010G* also supports 802.1D-2004 version Rapid Spanning Tree Protocol (RSTP). New version of RSTP standard includes 802.1D-1998 STP, 802.1w RSTP.

Following commands are included in this group:

4.4.1 RSTP

4.4.2 RSTP Info

4.4.3 Multiple Super Ring

4.4.4 Ring Info

4.4.5 Command Lines for Network Redundancy

4.4.1 RSTP

RSTP is the abbreviation of Rapid Spanning Tree Protocol. If a switch has more than one path to a destination, it will lead to message loops that can generate broadcast storms and quickly bog down a network. The spanning tree was created to combat the negative effects of message loops in switched networks. A spanning tree uses a spanning tree algorithm (STA) to automatically sense whether a switch has more than one way to communicate with a node. It will then select the best path (primary), and block the other path(s). It will also keep track of the blocked path(s) in case the primary path fails. Spanning Tree Protocol (STP) introduced a standard method to accomplish this. It is specified in IEEE 802.1D-1998. Later, Rapid Spanning Tree Protocol (RSTP) was adopted and represents the evolution of STP, providing much faster spanning tree convergence after a topology change. This is specified in IEEE 802.1w. In 2004, 802.1w is included into 802.1D-2004 version. This switch supports both RSTP and STP (all switches that support RSTP are also backward compatible with switches that support only STP).

This page allows you to enable/disable RSTP, configure the global setting and port settings.

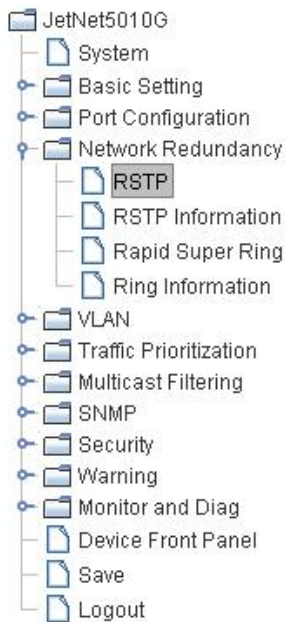

Rapid Spanning Tree Protocol

RSTP

Bridge Configuration

Priority	32768
Max Age(6-40 sec)	20
Hello Time(1-10 sec)	2
Forward Delay(4-30 sec)	15

Port Configuration

Port	Path Cost	Priority	Admin P2P	Admin Edge
1	200000	128	Auto	Enable
2	200000	128	Auto	Enable
3	200000	128	Auto	Enable
4	200000	128	Auto	Enable
5	200000	128	Auto	Enable
6	200000	128	Auto	Enable
7	200000	128	Auto	Enable
8	200000	128	Auto	Enable
9	200000	128	Auto	Enable
10	200000	128	Auto	Enable

Apply

RSTP Mode: You must first enable STP/RSTP mode, before configuring any related parameters. Parameter settings required for both STP and RSTP are the same. Note that 802.1d refers to STP mode, while 802.1w refers to faster RSTP mode.

Bridge Configuration

Priority (0-61440): RSTP uses bridge ID to determine the root bridge, the bridge with the highest bridge ID becomes the root bridge. The bridge ID is composed of bridge priority and bridge MAC address. So that the bridge with the highest priority becomes the highest bridge ID. If all the bridge ID has the same priority, the bridge with the lowest MAC address will then become the root bridge.

Note: The bridge priority value must be in multiples of 4096. A device with a lower number has a higher bridge priority. Ex: 4096 is higher than 32768.

Max Age (6-40): Enter a value from 6 to 40 seconds here. This value represents the time that a bridge will wait without receiving Spanning Tree Protocol configuration messages before attempting to reconfigure.

If JetNet is not the root bridge, and if it has not received a hello message from the root bridge in an amount of time equal to Max Age, then JetNet will reconfigure itself as a root bridge. Once two or more devices on the network are recognized as a root bridge, the devices will renegotiate to set up a new spanning tree topology.

Hello Time (1-10): Enter a value from 1 to 10 seconds here. This is a periodic timer that

drives the switch to send out BPDU (Bridge Protocol Data Unit) packet to check current STP status.

The root bridge of the spanning tree topology periodically sends out a “hello” message to other devices on the network to check if the topology is “healthy”. The “hello time” is the amount of time the root has waited during sending hello messages.

Forward Delay Time (4-30): Enter a value between 4 and 30 seconds. This value is the time that a port waits before changing from Spanning Tree Protocol learning and listening states to forwarding state.

This is the amount of time JetNet will wait before checking to see if it should be changed to a different state.

Once you have completed your configuration, click on **Apply** to apply your settings.

Note: You must observe the following rule to configure Hello Time, Forwarding Delay, and Max Age parameters.

$2 \times (\text{Forward Delay Time} - 1 \text{ sec}) \geq \text{Max Age Time} \geq 2 \times (\text{Hello Time value} + 1 \text{ sec})$

Port Configuration

Select the port you want to configure and you will be able to view current settings and status of the port.

Path Cost: Enter a number between 1 and 200,000,000. This value represents the “cost” of the path to the other bridge from the transmitting bridge at the specified port.

Priority: Enter a value between 0 and 240, using multiples of 16. This is the value that decides which port should be blocked by priority in a LAN.

Admin P2P: Some of the rapid state transitions that are possible within RSTP depend upon whether the port of concern can only be connected to another bridge (i.e. it is served by a point-to-point LAN segment), or if it can be connected to two or more bridges (i.e. it is served by a shared-medium LAN segment). This function allows P2P status of the link to be manipulated administratively. “**Auto**” means to auto select P2P or Share mode. “**P2P**” means P2P is enabled, while “**Share**” means P2P is disabled.

Admin Edge: A port directly connected to the end stations cannot create a bridging loop in the network. To configure this port as an edge port, set the port to the **Enable** state. When the non-bridge device connects an admin edge port, this port will be in blocking state and turn to forwarding state in 4 seconds.

Once you finish your configuration, click on **Apply** to save your settings.

4.4.2 RSTP Info

RSTP Information

Root Information

Bridge ID	8000.0012.7780.1455
Root Priority	32768
Root Port	N/A
Root Path Cost	0
Max Age(6-40)	20 sec
Hello Time(1-10)	2 sec
Forward Delay(4-30)	15 sec

Port Information

Port	Role	Port State	Path Cost	Port Priority	Oper P2P	Oper Edge
1	--	Disabled	200000	128	P2P	Edge
2	--	Disabled	200000	128	Shared	Edge
3	Designated	Forwarding	200000	128	P2P	Non-Edge
4	--	Disabled	200000	128	Shared	Edge
5	--	Disabled	200000	128	Shared	Edge
6	--	Disabled	200000	128	Shared	Edge
7	--	Disabled	200000	128	Shared	Edge
8	--	Disabled	200000	128	Shared	Edge
9	Designated	Forwarding	200000	128	P2P	Edge
10	Designated	Forwarding	200000	128	P2P	Edge

Reload

This page allows you to see the information of the root switch and port status.

Root Information: You can see root Bridge ID, Root Priority, Root Port, Root Path Cost and the Max Age, Hello Time and Forward Delay of BPDU sent from the root switch.

Port Information: You can see port Role, Port State, Path Cost, Port Priority, Oper P2P mode, Oper edge port mode and Aggregated(ID/Type).

4.4.3 Multiple Super Ring (MSR)

The most common industrial network redundancy is to form a ring or loop. Typically, the managed switches are connected in series and the last switch is connected back to the first one. In such connection, you can implement Korenix Super Ring, Rapid Super Ring, and Multiple Super Ring technology.

Super Ring is Korenix 1st generation ring redundancy technology released with JetNet 4000 and 4500 series managed switches. Rapid Super Ring is Korenix 2nd generation Ring redundancy technology released with old version of JetNet 5010G/4510.

Multiple Super Ring is Korenix 3rd generation Ring redundancy technology. This is Korenix pattern and protected in countries all over the world. The Multiple Super Ring has enhanced Ring Master selection and faster recovery time. It is also enhanced for more complex ring application.

This page allows you to enable the settings for Multiple Super Ring and Rapid Dual Homing.

New Ring: To create a Rapid Super Ring. Just fill in the Ring ID which has range from 0 to 31. If the name field is left blank, the name of this ring will automatically naming with Ring ID.

New Ring

Ring ID	Name
1	

Add

Ring Configuration

ID	Name	Version	Device Priority	Ring Port1	Path Cost	Ring Port2	Path Cost	Dual Homing II	Ring Status
1	Ring1	Rapid Super R	128	Port 1	128	Port 2	128	Disable	Enable

Apply Remove Reload

Ring Configuration

ID: Once a Ring is created, This appears and can not be changed.

Name: This field will show the name of the Ring. If it is not filled in when creating, it will be automatically named by the rule "RingID".

Version: The version of Ring can be changed here. There are three modes to choose: Rapid Super Ring as default; Super ring for compatible with Korenix 1st general ring and Any Ring for compatible with other version of rings.

Device Priority: The switch with highest priority (highest value) will be automatically selected as Ring Master. Then one of the ring ports in this switch will become forwarding port and the other one will become blocking port. If all of the switches have the same priority, the switch with the biggest MAC address will be selected as Ring Master.

Ring Port1: In Rapid Super Ring environment, you should have 2 Ring Ports. No matter this switch is Ring Master or not, when configuring RSR, 2 ports should be selected to be Ring Ports. For Ring Master, one of the ring ports will become the forwarding port and the other one will become the blocking port.

Path Cost: Change the Path Cost of Ring Port1. If this switch is the Ring Master of a Ring, then it determines the blocking port. The Port with higher Path Cost in the two ring Port will become the blocking port, If the Path Cost is the same, the port with larger port number will become the blocking port.

Ring Port2: Assign another port for ring connection

Path Cost: Change the Path Cost of Ring Port2

Rapid Dual Homing: Rapid Dual Homing is an important feature of Korenix 3rd generation Ring redundancy technology. When you want to connect multiple RSR or form redundant topology with other vendors, RDH could allow you to have maximum 7 multiple links for redundancy without any problem.

In Dual Homing I released with JetNet 4000/4500 series, you have to configure additional port as Dual Homing port to two uplink switches. In Rapid Dual Homing, you don't need to configure specific port to connect to other protocol. The Rapid Dual Homing will smartly choose the fastest link for primary link and block all the other link to avoid loop. If the primary link failed, Rapid Dual Homing will automatically forward the secondary link for network redundant. Of course, if there are more connections, they will be standby links and recover one of them if both primary and secondary links are broken.

Ring status: To enable/disable the Ring. Please remember to enable the ring after you add it.

4.4.4 Ring Info

This page shows the RSR information.

ID	Version	Role	Status	RM MAC	Blocking Port	Role Transition Count	Ring State Transition Count
1	Rapid Super Ring	RM	Normal	0012.7700.1455	fa2	2	4

ID: Ring ID.

Version: which version of this ring, this field could be Rapid Super Ring, Super Ring, or Any Ring

Role: This Switch is RM or nonRM

Status: If this field is Normal which means the redundancy is approved. If any one of the link in this Ring is broken, then the status will be Abnormal.

RM MAC: The MAC address of Ring Master of this Ring. It helps to find the redundant path.

Blocking Port: This field shows which is blocked port of RM.

Role Transition Count: This means how many times this switch has changed its Role from nonRM to RM or from RM to nonRM.

Role state Transition Count: This number means how many times the Ring status has been transformed between Normal and Abnormal state.

4.4.5 Command Lines:

Feature	Command Line
RSTP	
Enable	Switch(config)# spanning-tree enable
Disable	Switch (config)# spanning-tree disable
RSTP mode	Switch(config)# spanning-tree mode rapid-stp SpanningTree Mode change to be RST(802.1w) .
STP mode	Switch(config)# spanning-tree mode stp SpanningTree Mode change to be STP(802.1d) .
Priority	Switch(config)# spanning-tree priority <0-61440> valid range is 0 to 61440 in multiple of 4096 Switch(config)# spanning-tree priority 4096
Max Age	Switch(config)# spanning-tree max-age <6-40> Valid range is 6~40 seconds Switch(config)# spanning-tree max-age 10
Hello Time	Switch(config)# spanning-tree hello-time <1-10> Valid range is 1~10 seconds Switch(config)# spanning-tree hello-time 2
Forward Delay	Switch(config)# spanning-tree forward-time <4-30> Valid range is 4~30 seconds Switch(config)# spanning-tree forward-time 15
Port Path Cost	Switch(config-if)# spanning-tree cost <1-200000000> 16-bit based value range from 1-65535, 32-bit based value range from 1-200,000,000 Switch(config-if)# spanning-tree cost 200000
Port Priority	Switch(config-if)# spanning-tree port-priority <0-240> Number from 0 to 240, in multiple of 16 Switch(config-if)# spanning-tree port-priority 128
Link Type - Auto	Switch(config-if)# spanning-tree link-type auto
Link Type - P2P	Switch(config-if)# spanning-tree link-type point-to-point
Link Type – Share	Switch(config-if)# spanning-tree link-type shared
Edge Port	Switch(config-if)# spanning-tree edge-port enable Switch(config-if)# spanning-tree edge-port disable
RSTP Info	
Active status	Switch# show spanning-tree active Rapid Spanning-Tree feature Enabled Spanning-Tree BPDU transmission-limit 3 Root Address 0012.7701.0386 Priority 4096 Root Path Cost : 200000 Root Port : 7 Root Times : max-age 20 sec, hello-time 2 sec, forward-delay 15 sec Bridge Address 0012.77ff.0102 Priority 4096

	<p>Bridge Times : max-age 10 sec, hello-time 2 sec, forward-delay 15 sec Aging time : 300</p> <table border="1"> <thead> <tr> <th>Port</th> <th>Role</th> <th>Port-State</th> <th>Cost</th> <th>Prio.Nbr</th> <th>Type</th> </tr> </thead> <tbody> <tr> <td>fa6</td> <td>Designated</td> <td>Forwarding</td> <td>200000</td> <td>128.6</td> <td>Auto(RST)</td> </tr> <tr> <td>fa7</td> <td>Root</td> <td>Forwarding</td> <td>200000</td> <td>128.7</td> <td>Shared(STP)</td> </tr> </tbody> </table>	Port	Role	Port-State	Cost	Prio.Nbr	Type	fa6	Designated	Forwarding	200000	128.6	Auto(RST)	fa7	Root	Forwarding	200000	128.7	Shared(STP)
Port	Role	Port-State	Cost	Prio.Nbr	Type														
fa6	Designated	Forwarding	200000	128.6	Auto(RST)														
fa7	Root	Forwarding	200000	128.7	Shared(STP)														
RSTP Summary	<p>Switch# show spanning-tree summary Switch is in rapid-stp mode. BPDU skewing detection disabled for the bridge. Backbonefast disabled for bridge. Summary of connected spanning tree ports : #Port-State Summary</p> <table border="1"> <thead> <tr> <th>Blocking</th> <th>Listening</th> <th>Learning</th> <th>Forwarding</th> <th>Disabled</th> </tr> </thead> <tbody> <tr> <td>0</td> <td>0</td> <td>0</td> <td>2</td> <td>8</td> </tr> </tbody> </table> <p>#Port Link-Type Summary</p> <table border="1"> <thead> <tr> <th>AutoDetected</th> <th>PointToPoint</th> <th>SharedLink</th> <th>EdgePort</th> </tr> </thead> <tbody> <tr> <td>9</td> <td>0</td> <td>1</td> <td>9</td> </tr> </tbody> </table>	Blocking	Listening	Learning	Forwarding	Disabled	0	0	0	2	8	AutoDetected	PointToPoint	SharedLink	EdgePort	9	0	1	9
Blocking	Listening	Learning	Forwarding	Disabled															
0	0	0	2	8															
AutoDetected	PointToPoint	SharedLink	EdgePort																
9	0	1	9																
Port Info	<p>Switch# show spanning-tree port detail fa7 (Interface_ID) Rapid Spanning-Tree feature Enabled Port 128.6 as Disabled Role is in Disabled State Port Path Cost 200000, Port Identifier 128.6 RSTP Port Admin Link-Type is Auto, Oper Link-Type is Point-to-Point RSTP Port Admin Edge-Port is Enabled, Oper Edge-Port is Edge Designated root has priority 32768, address 0012.7700.0112 Designated bridge has priority 32768, address 0012.7760.1aec Designated Port ID is 128.6, Root Path Cost is 600000 Timers : message-age 0 sec, forward-delay 0 sec</p> <p>Link Aggregation Group: N/A, Type: N/A, Aggregated with: N/A</p> <p>BPDU: sent 43759 , received 4854 TCN : sent 0 , received 0 Forwarding-State Transmit count 12 Message-Age Expired count</p>																		
Multiple Super Ring																			
Create or configure a Ring	<p>Switch(config)# multiple-super-ring 1 Ring 1 created Switch(config-multiple-super-ring)# Note: 1 is the target Ring ID which is going to be created or configured.</p>																		
Super Ring Version	<p>Switch(config-multiple-super-ring)# version</p> <table border="1"> <tbody> <tr> <td>any-ring</td> <td>any ring auto detection</td> </tr> <tr> <td>default</td> <td>set default to rapid super ring</td> </tr> <tr> <td>rapid-super-ring</td> <td>rapid super ring</td> </tr> <tr> <td>super-ring</td> <td>super ring</td> </tr> </tbody> </table> <p>Switch(config-multiple-super-ring)# version rapid-super-ring</p>	any-ring	any ring auto detection	default	set default to rapid super ring	rapid-super-ring	rapid super ring	super-ring	super ring										
any-ring	any ring auto detection																		
default	set default to rapid super ring																		
rapid-super-ring	rapid super ring																		
super-ring	super ring																		
Priority	<p>Switch(config-multiple-super-ring)# priority <0-255> valid range is 0 to 255 default set default Switch(config)# super-ring priority 100</p>																		
Ring Port	<p>Switch(config-multiple-super-ring)# port IFLIST Interface list, ex: fa1,fa3-5,gi8-10 cost path cost</p>																		

	Switch(config-multiple-super-ring)# port fa1,fa2
Ring Port Cost	Switch(config-multiple-super-ring)# port cost <0-255> valid range is 0 or 255 default set default (128)valid range is 0 or 255 Switch(config-multiple-super-ring)# port cost 100 <0-255> valid range is 0 or 255 default set default (128)valid range is 0 or 255 Switch(config-super-ring-plus)# port cost 100 200 Set path cost success.
Rapid Dual Homing	Switch(config-multiple-super-ring)# rapid-dual-homing enable Switch(config-multiple-super-ring)# rapid-dual-homing disable Switch(config-multiple-super-ring)# rapid-dual-homing port IFLIST Interface name, ex: fastethernet1 or gi8 auto-detect up link auto detection IFNAME Interface name, ex: fastethernet1 or gi8 Switch(config-multiple-super-ring)# rapid-dual-homing port fa3,fa5-6 set Rapid Dual Homing port success. Note: auto-detect is recommended for dual Homing..
Ring Info	
Ring Info	Switch# show multiple-super-ring [Ring ID] [Ring1] Ring1 Current Status : Disabled Role : Disabled Ring Status : Abnormal Ring Manager : 0000.0000.0000 Blocking Port : N/A Giga Copper : N/A Configuration : Version : Rapid Super Ring Priority : 128 Ring Port : fa1, fa2 Path Cost : 100, 200 Dual-Homing II : Disabled Statistics : Watchdog sent 0, received 0, missed 0 Link Up sent 0, received 0 Link Down sent 0, received 0 Role Transition count 0 Ring State Transition count 1 Ring ID is optional. If the ring ID is typed, this command will only display the information of the target Ring.

4.5 VLAN

A Virtual LAN (VLAN) is a “logical” grouping of nodes for the purpose of limiting a broadcast domain to specific members of a group without physically grouping the members together. That means, VLAN allows you to isolate network traffic so that only members of VLAN could receive traffic from the same VLAN members. Basically, creating a VLAN from a switch is the logical equivalent of physically reconnecting a group of network devices to another Layer 2 switch, without actually disconnecting these devices from their original switches.

JetNet 5010G Series Industrial Ethernet Switch supports 802.1Q VLAN. 802.1Q VLAN is also known as Tag-Based VLAN. This Tag-Based VLAN allows VLAN to be created across different switches (see Figure 1). IEEE 802.1Q tag-based VLAN makes use of VLAN control information stored in a VLAN header attached to IEEE 802.3 packet frames. This tag contains a VLAN Identifier (VID) that indicates which VLAN a frame belongs to. Since each switch only has to check a frame’s tag, without the need to dissect the contents of the frame, this also saves a lot of computing resources within the switch.

Figure 4.5.1 802.1Q VLAN

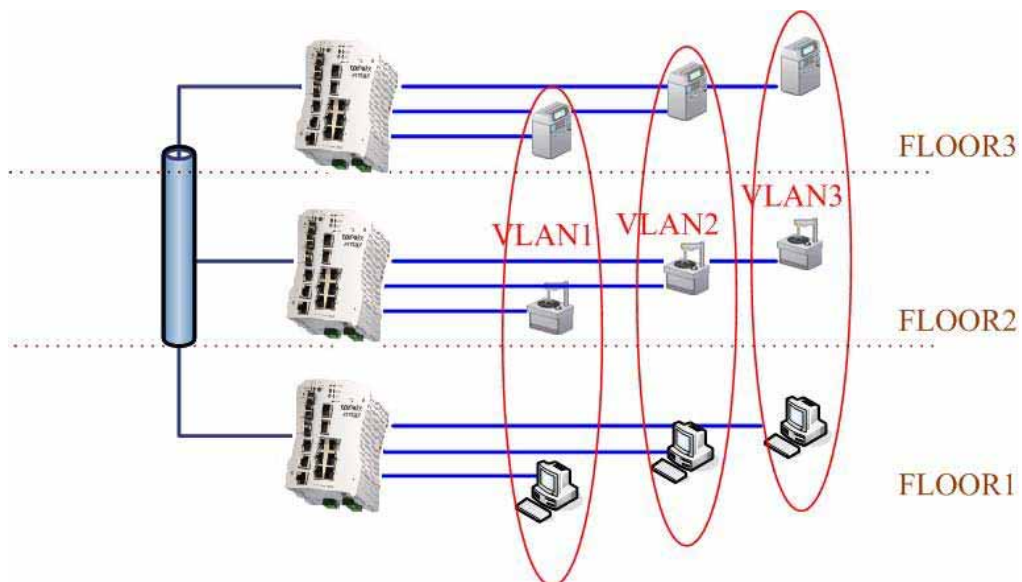

VLAN Configuration group enables you to Add/Remove VLAN, configure port Ingress/Egress parameters and view VLAN table.

Following commands are included in this group:

4.5.1 VLAN Port Configuration

4.5.2 VLAN Configuration

4.5.3 GVRP Configuration

4.5.4 VLAN Table

4.5.5 CLI Commands of the VLAN

4.5.1 VLAN Port Configuration

VLAN Port Configuration allows you to set up VLAN port parameters to specific port. These parameters include PVID, Accept Frame Type and Ingress Filtering.

Figure 4.5.2 Web UI of VLAN configuration.

VLAN Port Configuration

- JetNet5010G
 - System
 - Basic Setting
 - Port Configuration
 - Network Redundancy
 - VLAN
 - VLAN Port Configuration**
 - VLAN Configuration
 - GVRP Configuration
 - VLAN Table
 - Traffic Prioritization
 - Multicast Filtering
 - SNMP
 - Security
 - Warning
 - Monitor and Diag
 - Device Front Panel
 - Save
 - Logout

VLAN Port Configuration

Port	PVID	Accept Frame Type	Ingress Filtering
1	1	Admit All	Disable
2	1	Admit All	Disable
3	1	Admit All	Disable
4	1	Admit All	Disable
5	1	Admit All	Disable
6	1	Admit All	Disable
7	1	Admit All	Disable
8	1	Admit All	Disable
9	1	Admit All	Disable
10	1	Admit All	Disable

Apply

PVID: The abbreviation of the **Port VLAN ID**. Enter port VLAN ID here. PVID allows the switches to identify which port belongs to which VLAN. To keep things simple, it is recommended that PVID is equivalent to VLAN IDs.

The values of PVIDs are from 0 to 4095. But, 0 and 4095 are reserved. You can't input these 2 PVIDs. 1 is the default value. 2 to 4094 are valid and available in this column. Type the PVID you'd like to configure here.

Accept Frame Type: This column defines the accepted frame type of the port. There are 2 modes you can select, **Admit All** and **Tag Only**. Admit All mode means that the port can accept both tagged and untagged packets. Tag Only mode means that the port can only accept tagged packets.

Ingress Filtering: Ingress filtering helps VLAN engine to filter out undesired traffic on a port. When Ingress Filtering is enabled, the port checks whether the incoming frames belong to the VLAN they claimed or not. Then the port determines if the frames can be processed or not. For example, if a tagged frame from Engineer VLAN is received, and Ingress Filtering is enabled, the switch will determine if the port is on the Engineer VLAN's Egress list. If it is, the frame can be processed. If it's not, the frame would be dropped.

4.5.2 VLAN Configuration

In this page, you can assign Management VLAN, create the static VLAN, and assign the Egress rule for the member ports of the VLAN.

Figure 4.5.2.1 Web UI of the VLAN Configuration.

The screenshot shows the 'VLAN Configuration' page in the Korenix JetNet web interface. On the left is a navigation tree with 'VLAN Configuration' selected. The main content area has three sections: 'Management VLAN ID' with a text box containing '1' and an 'Apply' button; 'Static VLAN' with a table for adding new VLANs; and 'Static VLAN Configuration' with a table showing existing VLANs and their port statuses.

VLAN ID	Name	1	2	3	4	5	6	7	8	9	10
1	VLAN1	U	U	U	U	U	U	U	U	U	U

Management VLAN ID: The switch supports management VLAN. The management VLAN ID is the VLAN ID of the CPU interface so that only member ports of the management VLAN can ping and access the switch. The default management VLAN ID is 1.

Static VLAN: You can assign a VLAN ID and VLAN Name for new VLAN here.

VLAN ID is used by the switch to identify different VLANs. Valid VLAN ID is between 1 and 4094. 1 is the default VLAN.

VLAN Name is a reference for network administrator to identify different VLANs. The available character is 12 for you to input. If you don't input VLAN name, the system will automatically assign VLAN name for the VLAN. The rule is VLAN (VLAN ID).

Static VLAN

VLAN ID	NAME
3	test

Figure 4.5.2.2 The steps to create a new VLAN: Type VLAN ID and NAME, and press **Add** to create a new VLAN. Then you can see the new VLAN in the Static VLAN Configuration table. Refer to Figure 4.5.2.3

After created the VLAN, the status of the VLAN will

remain in Unused until you add ports to the VLAN.

Note: Before you change the management VLAN ID by Web and Telnet, remember that the port attached by the administrator should be the member port of the management VLAN; otherwise the administrator can't access the switch via the network.

Note: Currently JetNet 5010G only support max 64 group VLAN.

Static VLAN Configuration

You can see the created VLANs and specify the egress (outgoing) port rule to be **Untagged or Tagged** here.

Figure 4.5.2.3 Static VLAN Configuration table. You can see that new VLAN 3 is created. VLAN name is test. Egress rules of the ports are not configured now.

Static VLAN Configuration

VLAN ID	NAME	1	2	3	4	5	6	7	8	9	10
1	VLAN1	U	U	U	U	U	U	U	U	U	U
2	VLAN2	--	--	--	--	--	--	--	--	--	--
3	test	--	--	--	--	--	--	--	--	--	--

Apply Remove Reload

Figure 4.5.2.4 Configure Egress rule of the ports.

Static VLAN Configuration

VLAN ID	NAME	1	2	3	4	5	6	7	8	9	10
1	VLAN1	U	U	U	U	U	U	U	U	U	U
2	VLAN2	U	U	U	U	--	--	--	--	--	--
3	test	--	--	--	--	U	T	▼	T	T	T

Apply Remove Reload

-- : Not available

U: Untag: Indicates that egress/outgoing frames are not VLAN tagged.

T : Tag: Indicates that egress/outgoing frames are to be VLAN tagged.

Steps to configure Egress rules: Select the VLAN ID. Entry of the selected VLAN turns to light blue. Assign Egress rule of the ports to **U** or **T**. Press **Apply** to apply the setting. If you want to remove one VLAN, select the VLAN entry. Then press **Remove** button.

4.5.3 GVRP configuration

GVRP allows users to set-up VLANs automatically rather than manual configuration on every port of every switch in the network.

GVRP Configuration

GVRP Protocol:

Port	State	Join Timer	Leave Timer	Leave All Timer
1	Disable	20	60	1000
2	Disable	20	60	1000
3	Disable	20	60	1000
4	Disable	20	60	1000
5	Disable	20	60	1000
6	Disable	20	60	1000
7	Disable	20	60	1000
8	Disable	20	60	1000
9	Disable	20	60	1000
10	Disable	20	60	1000

Note: Timer unit is centiseconds.

GVRP Protocol: Allow user to enable/disable GVRP globally.

State: After enable GVRP globally, here still can enable/disable GVRP by port.

Join Timer: Controls the interval of sending the GVRP Join BPDU. An instance of this timer is required on a per-Port, per-GARP Participant basis

Leave Timer: Control the time to release the GVRP reservation after received the GVRP Leave BPDU. An instance of the timer is required for each state machine that is in the LV state

Leave All Timer: Controls the period to initiate the garbage collection of registered VLAN. The timer is required on a per-Port, per-GARP Participant basis

4.5.4 VLAN Table

This table shows you current settings of your VLAN table, including VLAN ID, Name, Status, and Egress rule of the ports.

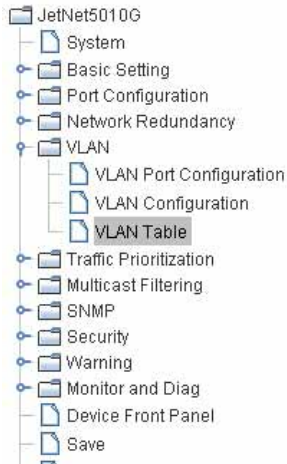

VLAN Table

VLAN Table

VLAN ID	Name	Status	1	2	3	4	5	6	7	8	9	10
1	VLAN1	Static	U	U	U	U	U	U	U	U	U	U
2	VLAN2	Unused	--	--	--	--	--	--	--	--	--	--
3	test	Static	--	--	U	U	--	T	T	T	--	--

Reload

VLAN ID: ID of the VLAN.

Name: Name of the VLAN.

Status: **Static** shows this is a manually configured static VLAN. **Unused** means this VLAN is created by UI/CLI and has no member ports. This VLAN is not workable yet. **Dynamic** means this VLAN is learnt by GVRP.

After created the VLAN, the status of this VLAN will remain in Unused status until you add ports to the VLAN.

4.5.5 CLI Commands of the VLAN

Command Lines of the VLAN port configuration, VLAN configuration and VLAN table display

Feature	Command Line
VLAN Port Configuration	
VLAN Port PVID	Switch(config-if)# switchport trunk native vlan 2 Set port default vlan id to 2 success
Port Accept Frame Type	Switch(config)# inter fa1 Switch(config-if)# acceptable frame type all any kind of frame type is accepted! Switch(config-if)# acceptable frame type vlantaggedonly only vlan-tag frame is accepted!
Ingress Filtering (for fast Ethernet port 1)	Switch(config)# interface fa1 Switch(config-if)# ingress filtering enable ingress filtering enable Switch(config-if)# ingress filtering disable ingress filtering disable
Egress rule – Untagged (for VLAN 2)	Switch(config-if)# switchport access vlan 2 switchport access vlan - success
Egress rule – Tagged	Switch(config-if)# switchport trunk allowed vlan add 2

(for VLAN 2)	
Display – Port Ingress Rule (PVID, Ingress Filtering, Acceptable Frame Type)	<pre>Switch# show interface fa1 Interface fastethernet1 Administrative Status : Enable Operating Status : Not Connected Duplex : Auto Speed : Auto Flow Control :off Default Port VLAN ID: 2 Ingress Filtering : Disabled Acceptable Frame Type : All Port Security : Disabled Auto Negotiation : Enable Loopback Mode : None STP Status: disabled Default CoS Value for untagged packets is 0. Mdx mode is Auto. Medium mode is Copper.</pre>
Display – Port Egress Rule (Egress rule, IP address, status)	<pre>Switch# show running-config ! interface fastethernet1 switchport access vlan 1 switchport access vlan 3 switchport trunk native vlan 2 interface vlan1 ip address 192.168.10.8/24 no shutdown</pre>
VLAN Configuration	
Create VLAN (2)	<pre>Switch(config)# vlan 2 vlan 2 success Switch(config)# interface vlan 2 Switch(config-if)#</pre> <p><i>Note: In CLI configuration, you should create a VLAN interface first. Then you can start to add/remove ports. Default status of the created VLAN is unused until you add member ports to it.</i></p>
Remove VLAN	<pre>Switch(config)# no vlan 2 no vlan success</pre> <p><i>Note: You can only remove the VLAN when the VLAN is in unused mode.</i></p>
VLAN Name	<pre>Switch(config)# vlan 2 vlan 2 has exists Switch(config-vlan)# name v2 Switch(config-vlan)# no name</pre> <p><i>Note: Use no name to change the name to default name, VLAN VID.</i></p>
VLAN description	<pre>Switch(config)# interface vlan 2 Switch(config-if)#</pre>

	Switch(config-if)# description this is the VLAN 2 Switch(config-if)# no description ->Delete the description.
IP address of the VLAN	Switch(config)# interface vlan 2 Switch(config-if)# Switch(config-if)# ip address 192.168.10.18/24 Switch(config-if)# no ip address 192.168.10.8/24 ->Delete the IP address
Create multiple VLANs (VLAN 5-10)	Switch(config)# interface vlan 5-10
Shut down VLAN	Switch(config)# interface vlan 2 Switch(config-if)# shutdown Switch(config-if)# no shutdown ->Turn on the VLAN
Display – VLAN table	Switch# sh vlan <pre> VLAN Name Status Trunk Ports Access Ports ---- - 1 VLAN1 Static - fa1-7,gi8-10 2 VLAN2 Unused - - 3 test Static fa4-7,gi8-10 fa1-3,fa7,gi8-10 </pre>
Display – VLAN interface information	Switch# show interface vlan1 <pre> interface vlan1 is up, line protocol detection is disabled index 14 metric 1 mtu 1500 <UP,BROADCAST,RUNNING,MULTICAST> HWaddr: 00:12:77:ff:01:b0 inet 192.168.10.100/24 broadcast 192.168.10.255 input packets 639, bytes 38248, dropped 0, multicast packets 0 input errors 0, length 0, overrun 0, CRC 0, frame 0, fifo 0, missed 0 output packets 959, bytes 829280, dropped 0 output errors 0, aborted 0, carrier 0, fifo 0, heartbeat 0, window 0 collisions 0 </pre>
GVRP configuration	
GVRP enable/disable	Switch(config)# gvrp mode disable Disable GVRP feature globally on the switch enable Enable GVRP feature globally on the switch Switch(config)# gvrp mode enable Gvrp is enabled on the switch!
Configure GVRP timer Join timer /Leave timer/ LeaveAll timer	Switch(config)# inter fa1 Switch(config-if)# garp timer <10-10000> Switch(config-if)# garp timer 20 60 1000 Note: The unit of these timer is centisecond
Management VLAN	
Management VLAN	Switch(config)# int vlan 1 (Go to management VLAN) Switch(config-if)# no shutdown
Display	Switch# show running-config <pre> ! interface vlan1 ip address 192.168.10.17/24 ip igmp no shutdown ! </pre>

4.6 Traffic Prioritization

Quality of Service (QoS) provides traffic prioritization mechanism which allows users to deliver better service to certain flows. QoS can also help to alleviate congestion problems and ensure high-priority traffic is delivered first. This section allows you to configure Traffic Prioritization settings for each port with regard to setting priorities.

JetNet QoS supports 4 physical queues, weighted fair queuing (WRR) and Strict Priority scheme, which follows 802.1p COS tag and IPv4 TOS/DiffServ information to prioritize the traffic of your industrial network.

Following commands are included in this group:

4.6.1 QoS Setting

4.6.2 CoS-Queue Mapping

4.6.3 DSCP-Queue Mapping

4.6.4 CLI Commands of the Traffic Prioritization

4.6.1 QoS Setting

Queue Scheduling

Use an 8,4,2,1 weighted fair queuing scheme

Use a strict priority scheme

Port Setting

Port	CoS	Trust Mode
1	0	COS Only
2	0	COS Only
3	0	COS Only
4	0	COS Only
5	0	COS Only
6	0	COS Only
7	0	COS Only
8	0	COS Only
9	0	COS Only
10	0	COS Only

Apply

Queue Scheduling

You can select the Queue Scheduling rule as follows:

Use an 8,4,2,1 weighted fair queuing scheme. This is also known as **WRR** (Weight Round Robin). JetNet will follow 8:4:2:1 rate to process the packets in a queue from the highest priority to the lowest. For example, the system will process 8 packets with the highest priority in the queue, 4 with middle priority, 2 with low priority, and 1 with the lowest priority at the same time.

Use a strict priority scheme. Packets with higher priority in the queue will always be processed first, except that there is no packet with higher priority.

Port Setting

CoS column is to indicate default port priority value for untagged or priority-tagged frames. When JetNet receives the frames, JetNet will attach the value to the CoS field of the incoming VLAN-tagged packets. You can enable 0,1,2,3,4,5,6 or 7 to the port.

Trust Mode is to indicate Queue Mapping types for you to select.

COS Only: Port priority will only follow COS-Queue Mapping you have assigned.

DSCP Only: Port priority will only follow DSCP-Queue Mapping you have assigned.

COS first: Port priority will follow COS-Queue Mapping first, and then DSCP-Queue Mapping rule.

DSCP first: Port priority will follow DSCP-Queue Mapping first, and then COS-Queue Mapping rule.

Default priority type is **COS Only**. The system will provide default COS-Queue table to which you can refer for the next command.

After configuration, press **Apply** to enable the settings.

4.6.2 CoS-Queue Mapping

This page is to change CoS values to Physical Queue mapping table. Since the switch fabric of JetNet only supports 4 physical queues, Lowest, Low, Middle and High. Users should therefore assign how to map CoS value to the level of the physical queue.

In JetNet, users can freely assign the mapping table or follow the suggestion of the 802.1p standard. Korenix uses 802.p suggestion as default values. You can find CoS values 1 and 2 are mapped to physical Queue 0, the lowest queue. CoS values 0 and 3 are mapped to physical Queue 1, the low/normal physical queue. CoS values 4 and 5 are mapped to physical Queue 2, the middle physical queue. CoS values 6 and 7 are mapped to physical Queue 3, the high physical queue.

CoS-Queue Mapping

CoS-Queue Mapping

CoS	0	1	2	3	4	5	6	7
Queue	1	0	0	1	2	2	3	3

Note: Queue 3 is the highest priority queue.

Apply

After configuration, press **Apply** to enable the settings.

4.6.3 DSCP-Queue Mapping

This page is to change DSCP values to Physical Queue mapping table. Since the switch fabric of JetNet only supports 4 physical queues, Lowest, Low, Middle and High. Users should therefore assign how to map DSCP value to the level of the physical queue. In JetNet, users can freely change the mapping table to follow the upper layer 3 switch or routers' DSCP setting.

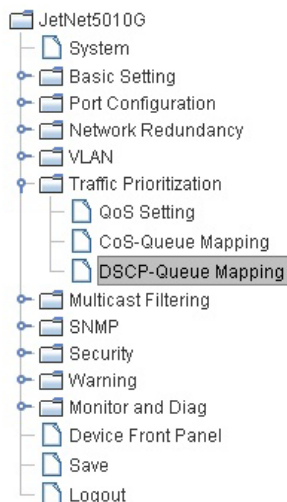

Traffic Prioritization

DSCP-Queue Mapping

DSCP	0	1	2	3	4	5	6	7
Queue	1	1	1	1	1	1	1	1
DSCP	8	9	10	11	12	13	14	15
Queue	0	0	0	0	0	0	0	0
DSCP	16	17	18	19	20	21	22	23
Queue	0	0	0	0	0	0	0	0
DSCP	24	25	26	27	28	29	30	31
Queue	1	1	1	1	1	1	1	1
DSCP	32	33	34	35	36	37	38	39
Queue	2	2	2	2	2	2	2	2
DSCP	40	41	42	43	44	45	46	47
Queue	2	2	2	2	2	2	2	2
DSCP	48	49	50	51	52	53	54	55
Queue	3	3	3	3	3	3	3	3
DSCP	56	57	58	59	60	61	62	63
Queue	3	3	3	3	3	3	3	3

Note: Queue 3 is the highest priority queue.

Apply

After configuration, press **Apply** to enable the settings.

4.6.4 CLI Commands of the Traffic Prioritization

Command Lines of the Traffic Prioritization configuration

Feature	Command Line
QoS Setting	
Queue Scheduling – Strict Priority	Switch(config)# qos queue-sched sp Strict Priority wrr Weighted Round Robin (Use an 8,4,2,1 weight) Switch(config)# qos queue-sched sp <cr>
Queue Scheduling - WRR	Switch(config)# qos queue-sched wrr
Port Setting – CoS (Default Port Priority)	Switch(config)# interface fa1 Switch(config-if)# qos cos DEFAULT-COS Assign an priority (7 highest) Switch(config-if)# qos cos 7

	The default port CoS value is set 7 ok. Note: When change the port setting, you should Select the specific port first. Ex: fa1 means fast Ethernet port 1.
Port Setting – Trust Mode- CoS Only	Switch(config)# interface fa1 Switch(config-if)# qos trust cos The port trust is set CoS only ok.
Port Setting – Trust Mode- CoS First	Switch(config)# interface fa1 Switch(config-if)# qos trust cos-first The port trust is set CoS first ok.
Port Setting – Trust Mode- DSCP Only	Switch(config)# interface fa1 Switch(config-if)# qos trust dscp The port trust is set DSCP only ok.
Port Setting – Trust Mode- DSCP First	Switch(config)# interface fa1 Switch(config-if)# qos trust dscp-first The port trust is set DSCP first ok.
Display – Queue Scheduling	Switch# show qos queue-sched QoS queue scheduling scheme : Weighted Round Robin (Use an 8,4,2,1 weight)
Display – Port Setting - Trust Mode	Switch# show qos trust QoS Port Trust Mode : Port Trust Mode -----+----- 1 DSCP first 2 COS only 3 COS only 4 COS only 5 COS only 6 COS only 7 COS only 8 COS only 9 COS only 10 COS only
Display – Port Setting – CoS (Port Default Priority)	Switch# show qos port-cos Port Default Cos : Port CoS -----+----- 1 7 2 0 3 0 4 0 5 0 6 0 7 0 8 0 9 0 10 0
CoS-Queue Mapping	
Format	Switch(config)# qos cos-map PRIORITY Assign an priority (7 highest) Switch(config)# qos cos-map 1 QUEUE Assign an queue (0-3) Note: Format: qos cos-map priority_value queue_value
Map CoS 0 to Queue 1	Switch(config)# qos cos-map 0 1 The CoS to queue mapping is set ok.

Map CoS 1 to Queue 0	Switch(config)# qos cos-map 1 0 The CoS to queue mapping is set ok.
Map CoS 2 to Queue 0	Switch(config)# qos cos-map 2 0 The CoS to queue mapping is set ok.
Map CoS 3 to Queue 1	Switch(config)# qos cos-map 3 1 The CoS to queue mapping is set ok.
Map CoS 4 to Queue 2	Switch(config)# qos cos-map 4 2 The CoS to queue mapping is set ok.
Map CoS 5 to Queue 2	Switch(config)# qos cos-map 5 2 The CoS to queue mapping is set ok.
Map CoS 6 to Queue 3	Switch(config)# qos cos-map 6 3 The CoS to queue mapping is set ok.
Map CoS 7 to Queue 3	Switch(config)# qos cos-map 7 3 The CoS to queue mapping is set ok.
Display – CoS-Queue mapping	Switch# sh qos cos-map CoS to Queue Mapping : CoS Queue ---- + ----- 0 1 1 0 2 0 3 1 4 2 5 2 6 3 7 3
DSCP-Queue Mapping	
Format	Switch(config)# qos dscp-map PRIORITY Assign an priority (63 highest) Switch(config)# qos dscp-map 0 QUEUE Assign an queue (0-3) Format: qos dscp-map priority_value queue_value
Map DSCP 0 to Queue 1	Switch(config)# qos dscp-map 0 1 The TOS/DSCP to queue mapping is set ok.
Display – DSCO-Queue mapping	Switch# show qos dscp-map DSCP to Queue Mapping : (dscp = d1 d2) d2 0 1 2 3 4 5 6 7 8 9 d1 -----+----- 0 1 1 1 1 1 1 1 1 0 0 1 0 0 0 0 0 0 0 0 0 0 2 0 0 0 0 1 1 1 1 1 1 3 1 1 2 2 2 2 2 2 2 2 4 2 2 2 2 2 2 2 3 3 3 5 3 3 3 3 3 3 3 3 3 3 6 3 3 3 3

4.7 Multicast Filtering

For multicast filtering, JetNet 5010G uses IGMP Snooping technology. IGMP (Internet Group Management Protocol) is an Internet Protocol that provides a way for internet device to report its multicast group membership to adjacent routers. Multicasting allows one computer on the internet to send data to a multitude of other computers that have identified themselves as being interested in receiving the originating computers data.

Multicasting is useful for such applications as updating the address books of mobile computer users in the field, sending out newsletters to a distribution list, and broadcasting streaming media to an audience that has tuned into the event by setting up multicast group membership.

In effect, IGMP Snooping manages multicast traffic by making use of switches, routers, and hosts that support IGMP. Enabling IGMP Snooping allows the ports to detect IGMP queries, report packets, and manage multicast traffic through the switch. IGMP has three fundamental types of messages, as shown below:

Message	Description
Query	A message sent from the querier (an IGMP router or a switch) which asks for a response from each host that belongs to the multicast group.
Report	A message sent by a host to the querier to indicate that the host wants to be or is a member of a given group indicated in the report message.
Leave Group	A message sent by a host to the querier to indicate that the host has quit as a member of a specific multicast group.

You can enable **IGMP Snooping** and **IGMP Query** functions here. You will see the information of the IGMP Snooping function in this section, including different multicast groups' VID and member ports, and IP multicast addresses that range from 224.0.0.0 to 239.255.255.255.

In this section, Force filtering can determined whether the switch flooding unknown multicast or not.

Following commands are included in this group:

4.7.1 IGMP Snooping

4.7.2 IGMP Query

4.7.3 Force Filtering

4.7.4 CLI Commands of the Multicast Filtering

4.7.1 IGMP Snooping

This page is to enable IGMP Snooping feature, assign IGMP Snooping for specific VLAN, and view IGMP Snooping table from dynamic learnt or static manual key-in. JetNet5010G support IGMP snooping V1/V2/V3 automatically and IGMP query V1/V2.

IGMP Snooping, you can select **Enable** or **Disable** here. After enabling IGMP Snooping, you can then enable IGMP Snooping for specific VLAN. You can enable IGMP Snooping for some VLANs so that some of the VLANs will support IGMP Snooping and others won't.

To assign IGMP Snooping to VLAN, please select the **checkbox** of VLAN ID or select **Select All** checkbox for all VLANs. Then press **Enable**. In the same way, you can also **Disable** IGMP Snooping for certain VLANs.

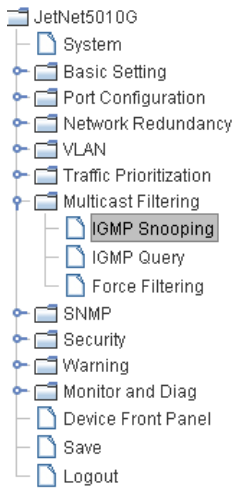

IGMP Snooping

IGMP Snooping Enable

Apply

	VID	IGMP Snooping
<input checked="" type="checkbox"/>	1	Enabled
<input checked="" type="checkbox"/>	2	Enabled
<input type="checkbox"/>	3	Disabled

Select All

Enable Disable

IGMP Snooping Table: In the table, you can see multicast group IP address, VLAN ID it belongs to, and member ports of the multicast group. JetNet 5010G supports 256 multicast groups. Click on **Reload** to refresh the table.

IGMP Snooping Table

IP Address	VID	1	2	3	4	5	6	7	8	9	10
239.255.255.250	1	<input type="checkbox"/>	<input type="checkbox"/>	<input type="checkbox"/>	<input type="checkbox"/>	<input type="checkbox"/>	<input checked="" type="checkbox"/>	<input type="checkbox"/>	<input type="checkbox"/>	<input type="checkbox"/>	<input type="checkbox"/>
239.192.8.0	1	<input type="checkbox"/>	<input type="checkbox"/>	<input type="checkbox"/>	<input type="checkbox"/>	<input type="checkbox"/>	<input checked="" type="checkbox"/>	<input type="checkbox"/>	<input type="checkbox"/>	<input type="checkbox"/>	<input type="checkbox"/>

Reload

4.7.2 IGMP Query

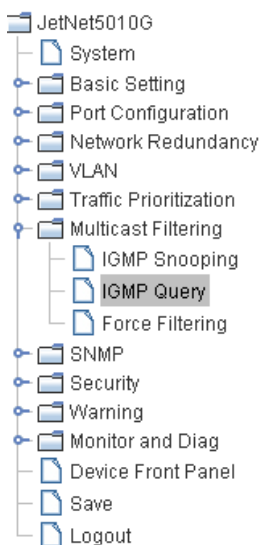

IGMP Query

IGMP Query on the Management VLAN

Version	Version 1
Query Interval(s)	125
Query Maximun Response Time(s)	10

Apply

This page allows users to configure **IGMP Query** feature. Since JetNet 5010G can only be configured by member ports of the management VLAN, IGMP Query can only be enabled on the management VLAN. If you want to run IGMP Snooping feature in several VLANs, you should notice that whether each VLAN has its own IGMP Querier first.

The IGMP querier periodically sends query packets to all end-stations on the LANs or VLANs that are connected to it. For networks with more than one IGMP querier, a switch with the lowest IP address becomes the IGMP querier.

In IGMP Query selection, you can select V1, V2 or Disable. **V1** means IGMP V1 General Query and **V2** means IGMP V2 General Query.. The query will be forwarded to all multicast groups in the VLAN. **Disable** allows you to disable IGMP Query.

Query Interval(s): The period of query sent by querier.

Query Maximum Response Time: The span querier detect to confirm there are no more directly connected group members on a LAN.

Once you finish configuring the settings, click on **Apply** to apply your configuration.

4.7.3 Force Filtering

Force Filtering

Force Filtering

The Force filtering function allows the switch to filter the unknown-multicast data flow. If Force filtering is enabled, all the unknown multicast data will be discarded.

4.7.4 CLI Commands of the Multicast Filtering

Command Lines of the multicast filtering configuration

Feature	Command Line
IGMP Snooping	
IGMP Snooping - Global	Switch(config)# ip igmp snooping IGMP snooping is enabled globally. Please specify on which vlans IGMP snooping enables
IGMP Snooping - VLAN	Switch(config)# ip igmp snooping vlan VLANLIST allowed vlan list all all existed vlan Switch(config)# ip igmp snooping vlan 1-2 IGMP snooping is enabled on VLAN 1-2.
Disable IGMP Snooping - Global	Switch(config)# no ip igmp snoopin IGMP snooping is disabled globally ok.
Disable IGMP Snooping - VLAN	Switch(config)# no ip igmp snooping vlan 3 IGMP snooping is disabled on VLAN 3.
Display – IGMP Snooping Setting	Switch# sh ip igmp interface vlan1 enabled: Yes version: IGMPv1 query-interval; 125s query-max-response-time: 10s Switch# sh ip igmp snooping

	IGMP snooping is globally enabled Vlan1 is IGMP snooping enabled Vlan2 is IGMP snooping enabled Vlan3 is IGMP snooping disabled												
Display – IGMP Table	Switch# sh ip igmp snooping multicast all <table border="1"> <thead> <tr> <th>VLAN</th> <th>IP Address</th> <th>Type</th> <th>Ports</th> </tr> </thead> <tbody> <tr> <td>1</td> <td>239.192.8.0</td> <td>IGMP</td> <td>fa6,</td> </tr> <tr> <td>1</td> <td>239.255.255.250</td> <td>IGMP</td> <td>fa6,</td> </tr> </tbody> </table>	VLAN	IP Address	Type	Ports	1	239.192.8.0	IGMP	fa6,	1	239.255.255.250	IGMP	fa6,
VLAN	IP Address	Type	Ports										
1	239.192.8.0	IGMP	fa6,										
1	239.255.255.250	IGMP	fa6,										
IGMP Query													
IGMP Query V1	Switch(config)# int vlan 1 (Go to management VLAN) Switch(config-if)# ip igmp v1												
IGMP Query V2	Switch(config)# int vlan 1 (Go to management VLAN) Switch(config-if)# ip igmp												
IGMP Query version	Switch(config-if)# ip igmp version 1 Switch(config-if)# ip igmp version 2												
Disable	Switch(config)# int vlan 1 Switch(config-if)# no ip igmp												
Display	Switch# sh ip igmp interface vlan1 enabled: Yes version: IGMPv2 query-interval: 125s query-max-response-time: 10s Switch# show running-config ! interface vlan1 ip address 192.168.10.17/24 ip igmp no shutdown !												
Force filtering													
Enable Force filtering	Switch(config)# mac-address-table multicast filtering Filtering unknown multicast addresses ok!												
Disable Force filtering	Switch(config)# no mac-address-table multicast filtering Flooding unknown multicast addresses ok!												

4.8 SNMP

Simple Network Management Protocol (SNMP) is a protocol used for exchanging management information between network devices. SNMP is a member of the TCP/IP protocol suite. JetNet 5010G series support SNMP v1 and v2c and V3.

An SNMP managed network consists of two main components: agents and a manager. An agent is a management software module that resides in a managed switch. An agent translates the local management information from the managed device into a SNMP compatible format. The manager is the console through the network.

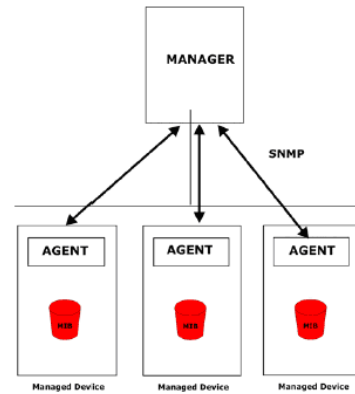

Following commands are included in this group:

4.8.1 SNMP Configuration

4.8.2 SNMPv3 Profile

4.8.3 SNMP Traps

4.8.4 SNMP CLI Commands for SNMP

4.8.1 SNMP Configuration

This page allows users to configure SNMP V1/V2c Community. The community string can be viewed as the password because SNMP V1/V2c doesn't request you to enter password before you try to access SNMP agent.

The community includes 2 privileges, Read Only and Read and Write.

With **Read Only** privilege, you only have the ability to read the values of MIB tables. Default community string is Public.

With **Read and Write** privilege, you have the ability to read and set the values of MIB tables. Default community string is Private.

JetNet 5010G allows users to assign 4 community strings. Type the community string and select the privilege. Then press **Apply**.

Note: When you first install the device in your network, we highly recommend you to change the community string. Since most SNMP management application uses Public and Private as their default community name, this might be the leakage of the network security.

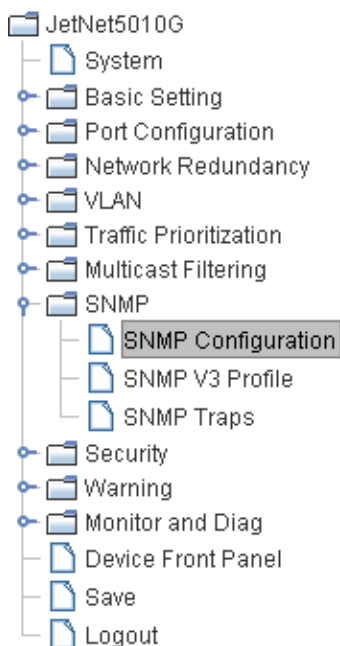

SNMP

SNMP V1/V2c Community

Community String	Privilege
public	Read Only ▼
private	Read and Write ▼
	Read Only ▼
	Read Only ▼

Apply

4.8.2 SNMP V3 Profile

SNMP v3 can provide more security functions when the user performs remote management through SNMP protocol. It delivers SNMP information to the administrator with user authentication; all of data between *JetNet 5010G* and the administrator are encrypted to ensure secure communication.

SNMP V3 Profile

SNMP V3

User Name	<input type="text"/>
Security Level	Authentication ▼
Authentication Protocol	SHA ▼
Authentication Password	<input type="text"/>
DES Encryption Password	<input type="text"/>

Add

Security Level: Here the user can select the following levels of security: None, User Authentication, and Authentication with privacy.

Authentication Protocol: Here the user can select either MD5 (Message-Digest algorithm 5) or SHA (Secure Hash Algorithm). MD5 is a widely used cryptographic hash function with a 128-bit hash value. SHA (Secure Hash Algorithm) hash functions refer to five Federal Information Processing Standard-approved algorithms for computing a condensed digital representation. *JetNet 5010G* provides 2 user authentication protocols in MD5 and SHA. You will need to configure SNMP v3 parameters for your SNMP tool with the same authentication method.

Authentication Password: Here the user enters the SNMP v3 user authentication password.

DES Encryption Password: Here the user enters the password for SNMP v3 user DES Encryption.

4.8.3 SNMP Traps

SNMP Trap is the notification feature defined by SNMP protocol. All the SNMP management applications can understand such trap information. So you don't need to install new application to read the notification information.

This page allows users to **Enable SNMP Trap**, configure the **SNMP Trap server IP**, **Community** name, and trap **Version V1 or V2**. After configuration, you can see the change of the SNMP pre-defined standard traps and Korenix pre-defined traps. The pre-defined traps can be found in Korenix private MIB.

SNMP Trap

SNMP Trap

Apply

SNMP Trap Server

Server IP	<input type="text" value="192.168.10.100"/>
Community	<input type="text" value="private"/>
Version	<input type="radio"/> V1 <input checked="" type="radio"/> V2c

Add

Trap Server Profile

Server IP	Community	Version
192.168.10.33	public	V1

Remove **Reload**

4.8.4 CLI Commands of the SNMP

Command Lines of the SNMP configuration

Feature	Command Line
SNMP Community	
Read Only Community	Switch(config)# snmp-server community public ro community string add ok
Read Write Community	Switch(config)# snmp-server community private rw community string add ok
SNMP Trap	
Enable Trap	Switch(config)# snmp-server enable trap Set SNMP trap enable ok.
SNMP Trap Server IP without specific community name	Switch(config)# snmp-server host 192.168.10.33 SNMP trap host add OK.
SNMP Trap Server IP with version 1 and community	Switch(config)# snmp-server host 192.168.10.33 version 1 private SNMP trap host add OK. Note: private is the community name, version 1 is the SNMP version
SNMP Trap Server IP with version 2 and community	Switch(config)# snmp-server host 192.168.10.33 version 2 private SNMP trap host add OK.
Disable SNMP Trap	Switch(config)# no snmp-server enable trap Set SNMP trap disable ok.
Display	Switch# sh snmp-server trap SNMP trap: Enabled SNMP trap community: public Switch# show running-config snmp-server community public ro snmp-server community private rw snmp-server enable trap snmp-server host 192.168.10.33 version 2 admin snmp-server host 192.168.10.33 version 1 admin

4.9 Security

JetNet 5010G provides several security features for you to secure your connection. The features include Port Security and IP Security.

Following commands are included in this group:

4.9.1 Port Security

4.9.2 IP Security

4.9.3 IEEE 802.1x

4.9.4 CLI Commands of the Security

4.9.1 Port Security

Port Security feature allows you to stop the MAC address learning for specific port. After stopping MAC learning, only the MAC address listed in Port Security List can access the switch and transmit/receive traffic. This is a simple way to secure your network environment and not to be accessed by hackers.

This page allows you to enable Port Security and configure Port Security entry.

Port Security State: Change Port Security State of the port to Enable first.

Add Port Security Entry: Select the port, and type VID and MAC address. Format of the MAC address is xxxx.xxxx.xxxx. Ex: 0012.7701.0101. Max volume of one port is 10. So the system can accept 100 Port Security MAC addresses in total.

Port Security List: This table shows you those enabled port security entries. You can click on **Remove** to delete the entry.

The screenshot displays the 'Port Security' configuration page. On the left is a navigation tree with 'Security' > 'Port Security' selected. The main content area is divided into three sections:

- Port Security State:** A table with 10 rows, each representing a port (1-10). The 'State' column for all ports is set to 'Disable'.
- Add Port Security Entry:** A form with three input fields: 'Port' (set to 'Port 7'), 'VID' (set to '1'), and 'MAC Address' (set to '0012.7710.0102'). An 'Add' button is located below the form.
- Port Security List:** A table with a dropdown menu set to 'All'. It contains two entries:

Port	VID	MAC Address
7	1	0012.7710.0101
7	1	0012.7710.0102

An 'Remove' button is located below the table.

Once you finish configuring the settings, click on **Apply / Add** to apply your configuration.

4.9.2 IP Security

In IP Security section, you can set up specific IP addresses to grant authorization for management access to this JetNet via a web browser or Telnet.

IP Security: Select Enable and **Apply** to enable IP security function.

Add Security IP: You can assign specific IP addresses, and then press **Add**. Only these IP addresses can access and manage JetNet via a web browser or Telnet. Max security IP is 10.

Security IP List: This table shows you added security IP addresses. You can press **Remove** to delete, **Reload** to reload the table.

JetNet5010G

- System
- Basic Setting
- Port Configuration
- Network Redundancy
- VLAN
- Traffic Prioritization
- Multicast Filtering
- SNMP
- Security
 - Port Security
 - IP Security**
- Warning
- Monitor and Diag
- Device Front Panel
- Save
- Logout

IP Security

IP Security Enable ▾

Apply

Add Security IP

Security IP 192.168.10.33

Add

Security IP List

Index	Security IP
1	192.168.10.33

Remove **Reload**

Once you finish configuring the settings, click on **Apply** to apply your configuration.

4.9.3 IEEE 802.1x

4.9.3.1 802.1X configuration

IEEE 802.1X is the protocol that performing authentication to obtain access to IEEE 802 LANs. It is port-base network access control. With the function, JetNet 5010G could control which connection is available or not.

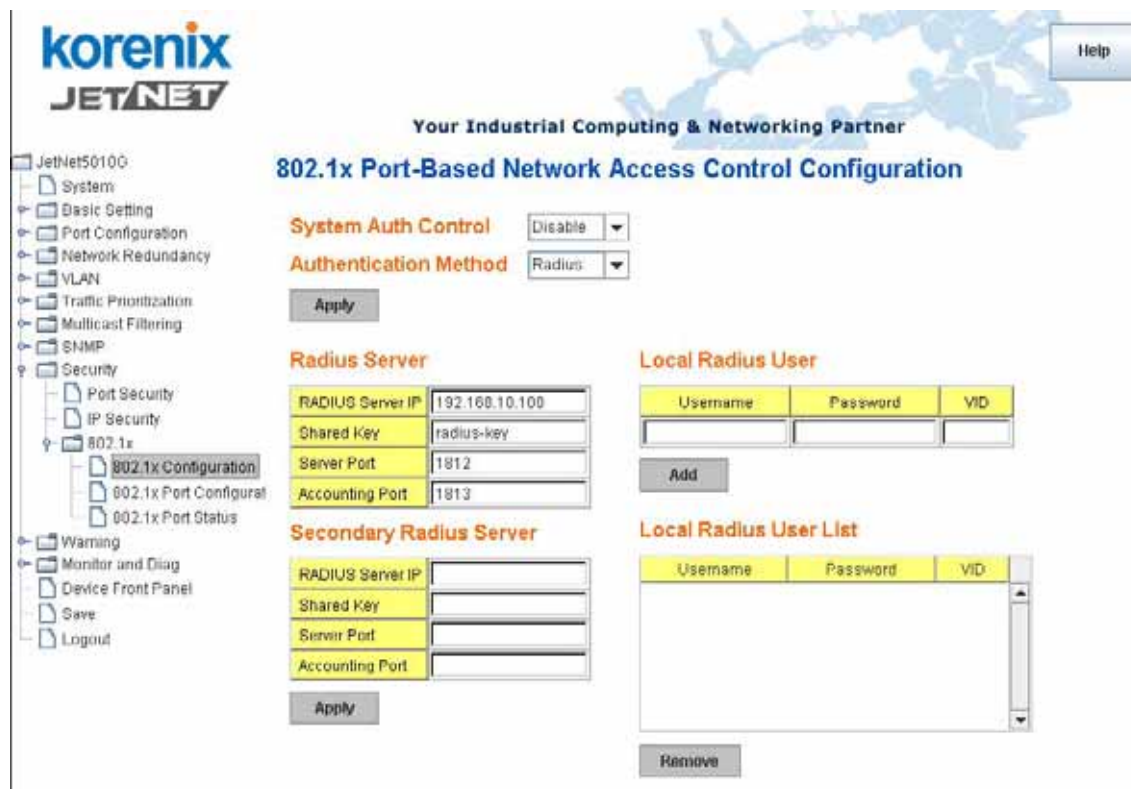

System AuthControl: To enable or disable the 802.1x authentication.

Authentication Method: Radius is a authentication server that provide key for authentication, with this method, user must connect switch to server. If user select Local for the authentication method, switch use the local user data base which can be create in this page for authentication.

Radius Server IP: The IP address of Radius server

Shared Key: The password for communicate between switch and Radius Server.

Server Port: UDP port of Radius server.

Accounting Port: Port for packets that contain the information of account login or logout.

Secondary Radius Server IP: Secondary Radius Server could be set in case of the primary radius server down.

802.1X Local User: Here User can add Account/Password for local authentication.

802.1X Local user List: This is a list shows the account information, User also can remove selected account Here.

4.9.3.2 802.1x Port Configuration

After the configuration of Radius Server or Local user list, user also need configure the authentication mode, authentication behavior, applied VLAN for each port and permitted communication. The following information will explain the port configuration.

The screenshot shows the Korenix JETNET web interface for a JetNet50100 switch. The left sidebar contains a navigation tree with categories like System, Basic Setting, Port Configuration, Network Redundancy, VLAN, Traffic Prioritization, Multicast Filtering, SNMP, Security, Warning, Monitor and Diag, Device Front Panel, Save, and Logout. The '802.1x' folder is expanded, showing sub-items for 802.1x Configuration, 802.1x Port Configuration, and 802.1x Port Status. The main content area is titled '802.1x Port-Based Network Access Control Port Configuration' and contains two tables.

802.1x Port Configuration

Port	Port Control	Reauthentication	Max Request	Guest VLAN	Host Mode	Admin Control Direction
1	Force Authorized	Disable	2	0	Single	Both
2	Force Authorized	Disable	2	0	Single	Both
3	Force Authorized	Disable	2	0	Single	Both
4	Force Authorized	Disable	2	0	Single	Both
5	Force Authorized	Disable	2	0	Single	Both
6	Force Authorized	Disable	2	0	Single	Both

Buttons: Apply, Initialize Selected, Reauthenticate Selected

802.1x Timeout Configuration

Port	Re-Auth Period(s)	Quiet Period(s)	Tx Period(s)	Supplicant Timeout(s)	Server Timeout(s)
1	3600	60	30	30	30
2	3600	60	30	30	30
3	3600	60	30	30	30
4	3600	60	30	30	30
5	3600	60	30	30	30
6	3600	60	30	30	30

Button: Apply

Port control: Force Authorized means this port is authorized; the data is free to in/out. Force unauthorized just opposite, the port is blocked. If users want to control this port with Radius Server, please select Auto for port control.

Reauthentication: If enable this field, switch will ask client to re-authenticate. The default time interval is 3600 seconds.

Max Request: the maximum times that the switch allow client request.

Guest VLAN: 0 to 4094 is available for this field. If this field is set to 0, that means the port is blocked after authentication fail. Otherwise, the port will be set to Guest VLAN.

Host Mode: if there are more than one device connected to this port, set the Host Mode to single means only the first PC authenticate success can access this port. If this port is set to multi, all the device can access this port once any one of them pass the authentication.

Control Direction: determined devices can end data out only or both send and receive.

Re-Auth Period: control the Re-authentication time interval, 1~65535 is available.

Quiet Period: When authentication failed, Switch will wait for a period and try to communicate with radius server again.

Tx period: the time interval of authentication request.

Supplicant Timeout: the timeout for the client authenticating

Sever Timeout: The timeout for server response for authenticating.

Once you finish configuring the settings, click on **Apply** to apply your configuration.

Click **Initialize Selected** to set the authorize state of selected port to initialize status.

Click **Reauthenticate Selected** to send EAP Request to supplicant to request reauthentication.

Click **Default Selected** to reset the configurable 802.1x parameters of selected port to the default values.

4.9.3.3 802.1X Port Status

Here user can observe the port status for Port control status, Authorize Status, Authorized Supplicant and Oper Control Direction each port.

Port	Port Control	Authorize Status	Authorized Supplicant	Oper Control Direction
1	Force Authorized	AUTHORIZED	NONE	Both
2	Force Authorized	AUTHORIZED	NONE	Both
3	Force Authorized	AUTHORIZED	NONE	Both
4	Force Authorized	AUTHORIZED	NONE	Both
5	Force Authorized	AUTHORIZED	NONE	Both
6	Force Authorized	AUTHORIZED	NONE	Both
7	Force Authorized	AUTHORIZED	NONE	Both

4.9.4 CLI Commands of the Security

Command Lines of the Security configuration

Feature	Command Line
Port Security	
Add MAC	Switch(config)# mac-address-table static 0012.7701.0101 vlan 1 interface fa1 mac-address-table unicast static set ok!

Port Security	Switch(config)# interface fa1 Switch(config-if)# switchport port-security Disables new MAC addresses learning and aging activities! Note: Rule: Add the static MAC, VLAN and Port binding first, then enable the port security to stop new MAC learning.
Disable Port Security	Switch(config-if)# no switchport port-security Enable new MAC addresses learning and aging activities!
Display	Switch# show mac-address-table static Destination Address Address Type Vlan Destination Port ----- 0012.7701.0101 Static 1 fa1
IP Security	
IP Security	Switch(config)# ip security Set ip security enable ok. Switch(config)# ip security host 192.168.10.33 Add ip security host 192.168.10.33 ok.
Display	Switch# show ip security ip security is enabled ip security host: 192.168.10.33
802.1x	
enable diable	Switch(config)# dot1x system-auth-control Switch(config)# Switch(config)# no dot1x system-auth-control Switch(config)#
authentic-method	Switch(config)# dot1x authentic-method local Use the local username database for authentication radius Use the Remote Authentication Dial-In User Service (RADIUS) servers for authentication Switch(config)# dot1x authentic-method radius Switch(config)#
radius server-ip	Switch(config)# dot1x radius Switch(config)# dot1x radius server-ip 192.168.10.120 key 1234 RADIUS Server Port number NOT given. (default=1812) RADIUS Accounting Port number NOT given. (default=1813) RADIUS Server IP : 192.168.10.120 RADIUS Server Key : 1234 RADIUS Server Port : 1812 RADIUS Accounting Port : 1813 Switch(config)#
radius server-ip	Switch(config)# dot1x radius Switch(config)# dot1x radius server-ip 192.168.10.120 key 1234 RADIUS Server Port number NOT given. (default=1812) RADIUS Accounting Port number NOT given. (default=1813) RADIUS Server IP : 192.168.10.120 RADIUS Server Key : 1234 RADIUS Server Port : 1812 RADIUS Accounting Port : 1813 Switch(config)#

radius secondary-server-ip	Switch(config)# dot1x radius secondary-server-ip 192.168.10.250 key 5678 Port number NOT given. (default=1812) RADIUS Accounting Port number NOT given. (default=1813) Secondary RADIUS Server IP : 192.168.10.250 Secondary RADIUS Server Key : 5678 Secondary RADIUS Server Port : 1812 Secondary RADIUS Accounting Port : 1813
User name/password for authentication	Switch(config)# dot1x username korenix passwd korenix vlan 1

4.10 Warning

JetNet 5010G provides several types of Warning features for you to remote monitor the status of end devices or the change of your network. The features include Fault Relay, System Log and SMTP E-mail Alert.

Following commands are included in this group:

- 4.10.1 Fault Relay
- 4.10.2 Event Selection
- 4.10.3 Syslog Configuration
- 4.10.4 SMTP Configuration
- 4.10.5 CLI Commands

4.10.1 Fault Relay

JetNet 5010G provides 2 digital outputs, also known as Relay Output. The relay contacts are energized (open) for normal operation and will close under fault conditions. Fault conditions include DI State change, Periodical On/Off, Power Failure, Ethernet port Link Failure, Ping Failure and Super Ring Topology Change. You can configure these settings in this Fault Relay Setting. Each Relay can be assigned 1 fault condition.

Relay 1: Click on checkbox of the Relay 1, then select the Event Type and its parameters.

Relay 2: Click on checkbox of the Relay 2, then select the Event Type and its parameters.

Event Type: DI State, Dry Output, Power Failure, Link Failure, Ping Failure and Super Ring Failure. Each event type has its own parameters. You should also configure them. Currently, each Relay can has one event type.

Fault Relay Setting

<input checked="" type="checkbox"/> Relay 1	
Event Type	DI state
DI Number	DI 1
DI State	High

<input checked="" type="checkbox"/> Relay 2	
Event Type	Link Failure
Link	DI state Dry Output Power Failure Link Failure Ping Failure Super Ring Failure

Apply

Event Type: **DI State**

DI Number: Select DI 1 or DI 2. Select which DI you want to monitor.

DI State: High or Low. Select the power voltage you want to monitor.

How to configure: Select the DI Number you want to monitor and DI State, High or Low. For example: When DI 1 and High are selected, it means when DI 1 is pulled high, the system will short Relay Output and light DO LED.

<input checked="" type="checkbox"/> Relay 1	
Event Type	DI state ▼
DI Number	DI 1 ▼
DI State	High ▼

Event Type: **Dry Output**

On Period (Sec): Type the period time to turn on Relay Output. Available range of a period is 0-4294967295 seconds.

Off Period (Sec): Type the period time to turn off Relay Output. Available range of a period is 0-4294967295 seconds.

How to configure: Type turn-on period and turn-off period when the time is reached, the system will turn on or off the Relay Output. If you connect DO to DI of the other terminal unit, the setting can help you to change DI state. If you connect DO to the power set of other terminal units, this setting can help you to turn on or off the unit.

<input checked="" type="checkbox"/> Relay 1	
Event Type	Dry Output ▼
On Period(Sec)	5
Off Period(Sec)	10

Relay turn on for 5 seconds then off for 10 seconds

How to turn On/Off the other device: Type “1” into the “On period” field and “0” into “Off Period” field and apply the setting, then it will be trigger to form as a close circuit. To turn off the relay, just type “0” into the “On period” field and “1” into “Off Period” field and apply the setting, the relay will be trigger to form as a open circuit. This function is also available in CLI, SNMP management interface. See the following setting.

<input checked="" type="checkbox"/> Relay 1		<input checked="" type="checkbox"/> Relay 1	
Event Type	Dry Output ▼	Event Type	Dry Output ▼
On Period(Sec)	1	On Period(Sec)	0
Off Period(Sec)	0	Off Period(Sec)	1

Turn on the relay output

Turn off the relay output

Event Type: **Power Failure**

Power ID: Select Power 1 or Power 2 you want to monitor. When the power is shut down or broken, the system will short Relay Out and light the DO LED.

<input checked="" type="checkbox"/> Relay 1	
Event Type	Power Failure ▼
Power ID	Power 1 ▼

Event Type: **Link Failure**

Link: Select the port ID you want to monitor.

How to configure: Select the checkbox of the Ethernet ports you want to monitor. You can select one or multiple ports. When the selected ports are linked down or broken, the system will short Relay Output and light the DO LED.

<input checked="" type="checkbox"/> Relay 1					
Event Type	Link Failure ▼				
Link	1	2	3	4	5
	<input checked="" type="checkbox"/>	<input checked="" type="checkbox"/>	<input checked="" type="checkbox"/>	<input checked="" type="checkbox"/>	<input type="checkbox"/>
	6	7	8	9	10
	<input type="checkbox"/>	<input type="checkbox"/>	<input type="checkbox"/>	<input type="checkbox"/>	<input type="checkbox"/>

Event Type: **Ping Failure**

IP Address: IP address of the target device you want to ping.

Reset Time (Sec): Waiting time to short the relay output.

Hold Time (Sec): Waiting time to ping the target device for the duration of remote device boot

<input checked="" type="checkbox"/> Relay 1	
Event Type	Ping Failure ▼
IP Address	192.168.10.2
Reset Time(Sec)	5
Hold Time(Sec)	50

How to configure: After selecting Ping Failure event type, the system will turn Relay Output to short state and continuously ping the target device. When the ping failure occurred, the switch will turn the Relay Output to open state for a period of Reset Time.

After the Reset Time timeout, the system will turn the Relay Output to close state. After the

Hold Time timer is timeout, the switch system will start ping the target device.

Ex: Reset Time is 5 sec, Hold Time is 50 sec.

If the ping failure occurred, the switch system will turn Relay output to open state to emulate power switch off for 5 sec periods. After Reset Time timeout, the Switch system will start ping target device after 50 sec periods. The period time is for target device system booting. During the period, the switch system will not ping target device until Hold Time is timeout.

Event Type: **Super Ring Failure**

Select Super Ring Failure. When the Rapid Super Ring topology is changed, the system will short Relay Out and lengthen DO LED.

The screenshot shows a configuration window with a yellow header bar containing a checked checkbox and the text 'Relay 1'. Below this is a section with a yellow background for the label 'Event Type' and a dropdown menu currently displaying 'Super Ring Failure'. The rest of the window is empty.

Once you finish configuring the settings, click on **Apply** to apply your configuration.

4.10.2 Event Selection

Event Types can be divided into two basic groups: System Events and Port Events. System Events are related to the overall function of the switch, whereas Port Events related to the activity of a specific ports

System Event	Warning Event is sent when.....
Device Cold Start	Power is cut off and then reconnected.
Device Warm Start	Reboot the device by CLI or Web UI.
Power 1 Failure	Power 1 is failure.
Power 2 Failure	Power 2 is failure.
Authentication failure	An incorrect password, SNMP Community String is entered.
Time Synchronize Failure	Accessing to NTP Server is failure.
Fault Relay	The DO/Fault Relay is on.
Super Ring Topology Changes	Master of Super Ring has changed or backup path is activated.
Port Event	Warning Event is sent when.....
Link-Up	The port is connected to another device

Link-Down	The port is disconnected (e.g. the cable is pulled out, or the opposing devices turns down)
-----------	---

Warning - Event Selection

System Event Selection

Device Cold Start Device Warm Start
 Power 1 Failure Power 2 Failure
 Authentication Failure Time Synchronize Failure
 Fault Relay Super Ring Topology Change

Port Event Selection

Port	Link State
1	Disable
2	Disable
3	Disable
4	Disable Link Down Link Up Both
5	Disable
6	Disable
7	Disable
8	Disable
9	Disable
10	Disable

Apply

Once you finish configuring the settings, click on **Apply** to apply your configuration.

4.10.3 SysLog Configuration

System Log is useful to provide system administrator locally or remotely monitor switch events history. There are 2 System Log modes provided by JetNet 5010G, local mode and remote mode.

Local Mode: In this mode, JetNet 5010G will print the occurred events selected in the Event Selection page to System Log table of JetNet 5010G. You can monitor the system logs in [Monitor and Diag] / [Event Log] page.

Remote Mode: The remote mode is also known as Server mode in JetNet 4500 series. In this mode, you should assign the IP address of the System Log server. JetNet 5010G will send the occurred events selected in Event Selection page to System Log server you assigned.

Both: Above 2 modes can be enabled at the same time.

Once you finish configuring the settings, click on **Apply** to apply your configuration.

Note: When enabling Local or Both mode, you can monitor the system logs in [Monitor and Diag] / [Event Log] page.

4.10.4 SMTP Configuration

JetNet 5010G supports E-mail Warning feature. The switch will send the occurred events to remote E-mail server. The receiver can then receive notification by E-mail. The E-mail warning is conformed to SMTP standard.

This page allows you to enable E-mail Alert, assign the SMTP Server IP, Sender E-mail, and Receiver E-mail. If SMTP server requests you to authorize first, you can also set up the username and password in this page.

Field	Description
SMTP Server IP Address	Enter the IP address of the email Server
Authentication	Click on check box to enable password
User Name	Enter email Account name (Max.40 characters)
Password	Enter the password of the email account
Confirm Password	Re-type the password of the email account
You can set up to 4 email addresses to receive email alarm from JetNet	
Rcpt E-mail Address 1	The first email address to receive email alert from JetNet (Max. 40 characters)
Rcpt E-mail Address 2	The second email address to receive email alert from JetNet (Max. 40 characters)
Rcpt E-mail Address 3	The third email address to receive email alert from JetNet (Max. 40 characters)
Rcpt E-mail Address 4	The fourth email address to receive email alert from JetNet (Max. 40 characters)

Once you finish configuring the settings, click on **Apply** to apply your configuration.

4.10.5 CLI Commands

Command Lines of the Warning configuration

Feature	Command Line
Relay Output	
Relay Output	Switch(config)# relay 1 di DI state dry dry output ping ping failure port port link failure power power failure ring super ring failure Note: Select Relay 1 or 2 first, then select the event types.
DI State	Switch(config)# relay 1 di <1-2> DI number Switch(config)# relay 1 di 1 high high is abnormal low low is abnormal Switch(config)# relay 1 di 1 high
Dry Output	Switch(config)# relay 1 dry <0-4294967295> turn on period in second Switch(config)# relay 1 dry 5 <0-4294967295> turn off period in second Switch(config)# relay 1 dry 5 5
Ping Failure	Switch(config)# relay 1 ping 192.168.10.33

	<pre><cr> reset reset a device Switch(config)# relay 1 ping 192.168.10.33 reset <1-65535> reset time Switch(config)# relay 1 ping 192.168.10.33 reset 60 <0-65535> hold time to retry Switch(config)# relay 1 ping 192.168.10.33 reset 60 60</pre>
Port Link Failure	<pre>Switch(config)# relay 1 port PORTLIST port list Switch(config)# relay 1 port fa1-5</pre>
Power Failure	<pre>Switch(config)# relay 1 power <1-2> power id Switch(config)# relay 1 power 1 Switch(config)# relay 1 power 2</pre>
Super Ring Failure	<pre>Switch(config)# relay 1 ring</pre>
Disable Relay	<pre>Switch(config)# no relay <1-2> relay id Switch(config)# no relay 1 (Relay_ID: 1 or 2) <cr></pre>
Display	<pre>Switch# show relay 1 Relay Output Type : Port Link Port : 1, 2, 3, 4, Switch# show relay 2 Relay Output Type : Super Ring</pre>
Event Selection	
Event Selection	<pre>Switch(config)# warning-event coldstart Switch cold start event warmstart Switch warm start event linkdown Switch link down event linkup Switch link up event all Switch all event authentication Authentication failure event fault-relay Switch fault relay event power Switch power failure event super-ring Switch super ring topology change event</pre>
Ex: Cold Start event	<pre>Switch(config)# warning-event coldstart Set cold start event enable ok.</pre>
Ex: Link Up event	<pre>Switch(config)# warning-event linkup [IFNAME] Interface name, ex: fastethernet1 or gi8 Switch(config)# warning-event linkup fa5 Set fa5 link up event enable ok.</pre>
Display	<pre>Switch# show warning-event Warning Event: Cold Start: Enabled Warm Start: Disabled Authentication Failure: Disabled Link Down: fa4-5 Link Up: fa4-5 Power Failure: Super Ring Topology Change: Disabled Fault Relay: Disabled Time synchronize Failure: Disable</pre>
Syslog Configuration	
Local Mode	<pre>Switch(config)# log syslog local</pre>
Server Mode	<pre>Switch(config)# log syslog remote 192.168.10.33</pre>
Both	<pre>Switch(config)# log syslog local</pre>

	Switch(config)# log syslog remote 192.168.10.33
Disable	Switch(config)# no log syslog local
SMTP Configuration	
SMTP Enable	Switch(config)# smtp-server enable email-alert SMTP Email Alert set enable ok.
Sender mail	Switch(config)# smtp-server server 192.168.10.100 ACCOUNT SMTP server mail account, ex: admin@korenix.com Switch(config)# smtp-server server 192.168.10.100 admin@korenix.com SMTP Email Alert set Server: 192.168.10.100, Account: admin@korenix.com ok.
Receiver mail	Switch(config)# smtp-server receipt 1 korecare@korenix.com SMTP Email Alert set receipt 1: korecare@korenix.com ok.
Authentication with username and password	Switch(config)# smtp-server authentication username admin password admin SMTP Email Alert set authentication Username: admin, Password: admin Note: You can assign string to username and password.
Disable SMTP	Switch(config)# no smtp-server enable email-alert SMTP Email Alert set disable ok.
Disable Authentication	Switch(config)# no smtp-server authentication SMTP Email Alert set Authentication disable ok.
Dispaly	Switch# sh smtp-server SMTP Email Alert is Enabled Server: 192.168.10.100, Account: admin@korenix.com Authentication: Enabled Username: admin, Password: admin SMTP Email Alert Receipt: Receipt 1: korecare@korenix.com Receipt 2: Receipt 3: Receipt 4:

4.11 Monitor and Diag

JetNet 5010G provides several types of features for you to monitor the status of the switch or diagnostic for you to check the problem when encountering problems related to the switch. The features include MAC Address Table, Port Statistics, Port Mirror, Event Log and Ping.

Following commands are included in this group:

4.11.1 MAC Address Table

4.11.2 Port Statistics

4.11.3 Port Mirror

4.11.4 Event Log

4.11.5 Ping

4.11.6 CLI Commands of the Monitor and Diag

4.11.1 MAC Address Table

JetNet 5010G provides 8K entries in MAC Address Table. In this page, users can change the Aging time, add Static Unicast MAC Address, monitor the MAC address or sort them by different packet types and ports. Click on **Apply** to change the value.

Aging Time (Sec)

Each switch fabric has limit size to write the learnt MAC address. To save more entries for new MAC address, the switch fabric will age out non-used MAC address entry per Aging Time timeout. The default Aging Time is 300 seconds. The Aging Time can be modified in this page.

Static Unicast MAC Address

In some applications, users may need to type in the static Unicast MAC address to its MAC address table. In this page, you can type MAC Address (format: xxxx.xxxx.xxxx), select its VID and Port ID, and then click on **Add** to add it to MAC Address table.

MAC Address Table

In this MAC Address Table, you can see all the MAC Addresses learnt by the switch fabric. The packet types include Management Unicast, Static Unicast, Dynamic Unicast, Static Multicast and Dynamic Multicast. The table allows users to sort the address by the packet types and port.

Packet Types: **Management Unicast** means MAC address of the switch. It belongs to CPU port only. **Static Unicast** MAC address can be added and deleted. **Dynamic Unicast** MAC is MAC address learnt by the switch Fabric. **Static Multicast** can be added by CLI and can be deleted by Web and CLI. **Dynamic Multicast** will appear after you enabled IGMP and the switch learnt IGMP report.

Click on **Remove** to remove the static Unicast/Multicast MAC address. Click on **Reload** to refresh the table. New learnt Unicast/Multicast MAC address will be updated to MAC address table.

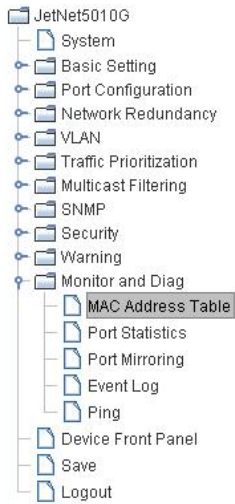

MAC Address Table

Aging Time (Sec)

Apply

Static Unicast MAC Address

MAC Address	VID	Port
<input type="text"/>	<input type="text"/>	Port 1 ▾

Add

MAC Address Table

MAC Address	Address Type	VID	1	2	3	4	5	6	7	8	9	10
000f.b079.ca3b	Dynamic Unicast	1	<input type="checkbox"/>	<input type="checkbox"/>	<input type="checkbox"/>	<input checked="" type="checkbox"/>	<input type="checkbox"/>	<input type="checkbox"/>	<input type="checkbox"/>	<input type="checkbox"/>	<input type="checkbox"/>	<input type="checkbox"/>
0012.7701.0386	Dynamic Unicast	1	<input type="checkbox"/>	<input type="checkbox"/>	<input type="checkbox"/>	<input type="checkbox"/>	<input type="checkbox"/>	<input type="checkbox"/>	<input checked="" type="checkbox"/>	<input type="checkbox"/>	<input type="checkbox"/>	<input type="checkbox"/>
0012.7710.0101	Static Unicast	1	<input type="checkbox"/>	<input type="checkbox"/>	<input type="checkbox"/>	<input type="checkbox"/>	<input type="checkbox"/>	<input type="checkbox"/>	<input checked="" type="checkbox"/>	<input type="checkbox"/>	<input type="checkbox"/>	<input type="checkbox"/>
0012.7710.0102	Static Unicast	1	<input type="checkbox"/>	<input type="checkbox"/>	<input type="checkbox"/>	<input type="checkbox"/>	<input type="checkbox"/>	<input type="checkbox"/>	<input checked="" type="checkbox"/>	<input type="checkbox"/>	<input type="checkbox"/>	<input type="checkbox"/>
0012.77ff.0100	Management Unicast	1	<input type="checkbox"/>	<input type="checkbox"/>	<input type="checkbox"/>	<input type="checkbox"/>	<input type="checkbox"/>	<input type="checkbox"/>	<input type="checkbox"/>	<input type="checkbox"/>	<input type="checkbox"/>	<input type="checkbox"/>
0100.5e40.0800	fa6 Multicast	1	<input type="checkbox"/>	<input type="checkbox"/>	<input type="checkbox"/>	<input type="checkbox"/>	<input type="checkbox"/>	<input type="checkbox"/>	<input type="checkbox"/>	<input type="checkbox"/>	<input type="checkbox"/>	<input type="checkbox"/>
0100.5e7f.ffff	fa4,fa6 Multicast	1	<input type="checkbox"/>	<input type="checkbox"/>	<input type="checkbox"/>	<input type="checkbox"/>	<input type="checkbox"/>	<input type="checkbox"/>	<input type="checkbox"/>	<input type="checkbox"/>	<input type="checkbox"/>	<input type="checkbox"/>

Remove

Reload

4.11.2 Port Statistics

In this page, you can view operation statistics for each port. The statistics that can be viewed include Link Type, Link State, Rx Good, Rx Bad, Rx Abort, Tx Good, Tx Bad and Collision. Rx means the received packet while Tx means the transmitted packets.

Note: If you see many Bad, Abort or Collision counts increased, that may mean your network cable is not connected well, the network performance of the port is poor...etc. Please check your network cable, Network Interface Card of the connected device, the network application, or reallocate the network traffic...etc.

Click on **Clear Selected** to reinitialize the counts of the selected ports, and **Clear All** to reinitialize the counts of all ports. Click on **Reload** to refresh the counts.

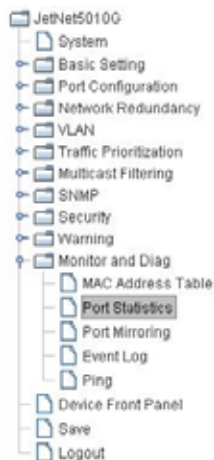

Port Statistics

Port	Type	Link	State	Rx Good	Rx Bad	Rx Abort	Tx Good	Tx Bad	Collision
1	100TX	Down	Enable	0	0	0	0	0	0
2	100TX	Down	Enable	10	0	0	11	0	0
3	100TX	Down	Enable	0	0	0	0	0	0
4	100TX	Up	Enable	2131	0	0	2452	0	0
5	100TX	Down	Enable	0	0	0	0	0	0
6	100TX	Down	Enable	4884	1	2	5919	0	0
7	100TX	Up	Enable	54	0	0	2742	0	0
8	100TX	Down	Enable	0	0	0	0	0	0
9	100TX	Down	Enable	0	0	0	0	0	0
10	100TX	Down	Enable	0	0	0	0	0	0

Clear Selected

Clear All

Reload

4.11.3 Port Mirroring

Port mirroring (also called port spanning) is a tool that allows you to mirror the traffic from one or more ports onto another port, without disrupting the flow of traffic on the original port. Any traffic that goes into or out of the Source Port(s) will be duplicated at the Destination Port. This traffic can then be analyzed at the Destination port using a monitoring device or application. A network administrator will typically utilize this tool for diagnostics, debugging, or fending off attacks.

Port Mirror Mode: Select Enable/Disable to enable/disable Port Mirror.

Source Port: This is also known as Monitor Port. These are the ports you want to monitor. The traffic of all source/monitor ports will be copied to destination/analysis ports. You can choose a single port, or any combination of ports, but you can only monitor them in Rx or TX only. Click on checkbox of the Port ID, RX, Tx or Both to select the source ports.

Destination Port: This is also known as Analysis Port. You can analyze the traffic of all the monitored ports at this port without affecting the flow of traffic on the port(s) being monitored. Only one RX/TX of the destination port can be selected. A network administrator would typically connect a LAN analyzer or Netxray device to this port.

Once you finish configuring the settings, click on **Apply** to apply the settings.

Port Mirroring

Port Mirror Mode

Port Selection

Port	Source Port		Destination Port	
	Rx	Tx	Rx	Tx
1	<input checked="" type="checkbox"/>	<input checked="" type="checkbox"/>	<input type="radio"/>	<input type="radio"/>
2	<input checked="" type="checkbox"/>	<input checked="" type="checkbox"/>	<input type="radio"/>	<input type="radio"/>
3	<input type="checkbox"/>	<input type="checkbox"/>	<input checked="" type="radio"/>	<input type="radio"/>
4	<input type="checkbox"/>	<input type="checkbox"/>	<input type="radio"/>	<input checked="" type="radio"/>
5	<input type="checkbox"/>	<input type="checkbox"/>	<input type="radio"/>	<input type="radio"/>
6	<input type="checkbox"/>	<input type="checkbox"/>	<input type="radio"/>	<input type="radio"/>
7	<input type="checkbox"/>	<input type="checkbox"/>	<input type="radio"/>	<input type="radio"/>
8	<input type="checkbox"/>	<input type="checkbox"/>	<input type="radio"/>	<input type="radio"/>
9	<input type="checkbox"/>	<input type="checkbox"/>	<input type="radio"/>	<input type="radio"/>
10	<input type="checkbox"/>	<input type="checkbox"/>	<input type="radio"/>	<input type="radio"/>

Apply

4.11.4 Event Log

In the 4.10.3, we have introduced System Log feature. When System Log Local mode is selected, JetNet 5010G will record occurred events in local log table. This page shows this log table. The entry includes the index, occurred data and time and content of the events.

Click on **Clear** to clear the entries. Click on **Reload** to refresh the table.

Index	Date	Time	Event Log
1	Jan 1	02:50:53	Event: Link 4 Up.
2	Jan 1	02:50:51	Event: Link 5 Down.
3	Jan 1	02:50:50	Event: Link 5 Up.
4	Jan 1	02:50:47	Event: Link 4 Down.

4.11.5 Ping Utility

This page provides **Ping Utility** for users to ping remote device and check whether the device is alive or not. Type **Target IP** address of the target device and click on **Start** to start the ping. After few seconds, you can see the result in the **Result** field.

```
PING 192.168.10.33 (192.168.10.33): 56 data bytes
64 bytes from 192.168.10.33: icmp_seq=0 ttl=128 time=0.0 ms
64 bytes from 192.168.10.33: icmp_seq=1 ttl=128 time=0.0 ms
64 bytes from 192.168.10.33: icmp_seq=2 ttl=128 time=0.0 ms
64 bytes from 192.168.10.33: icmp_seq=3 ttl=128 time=0.0 ms
64 bytes from 192.168.10.33: icmp_seq=4 ttl=128 time=0.0 ms

--- 192.168.10.33 ping statistics ---
5 packets transmitted, 5 packets received, 0% packet loss
round-trip min/avg/max = 0.0/0.0/0.0 ms
```

4.11.6 CLI Commands of the Monitor and Diag

Command Lines of the Monitor and Diag configuration

Feature	Command Line
MAC Address Table	
Ageing Time	Switch(config)# mac-address-table aging-time 350 mac-address-table aging-time set ok! <i>Note: 350 is the new ageing timeout value.</i>
Add Static Unicast MAC address	Switch(config)# mac-address-table static 0012.7701.0101 vlan 1 interface fastethernet7 mac-address-table ucast static set ok! Note: rule: mac-address-table static MAC_address VLAN VID interface interface_name
Add Multicast MAC address	Switch(config)# mac-address-table multicast 0100.5e01.0101 vlan 1 interface fa6-7 Adds an entry in the multicast table ok! Note: rule: mac-address-table multicast MAC_address VLAN VID interface_list interface_name/range
Show MAC Address Table – All types	Switch# show mac-address-table **** UNICAST MAC ADDRESS **** Destination Address Address Type Vlan Destination Port ----- 000f.b079.ca3b Dynamic 1 fa4 0012.7701.0386 Dynamic 1 fa7 0012.7710.0101 Static 1 fa7 0012.7710.0102 Static 1 fa7 0012.77ff.0100 Management 1 **** MULTICAST MAC ADDRESS **** Vlan Mac Address COS Status Ports ----- 1 0100.5e40.0800 0 fa6 1 0100.5e7f.ffa 0 fa4,fa6
Show MAC Address Table – Dynamic Learnt MAC addresses	Switch# show mac-address-table dynamic Destination Address Address Type Vlan Destination Port ----- 000f.b079.ca3b Dynamic 1 fa4 0012.7701.0386 Dynamic 1 fa7
Show MAC Address Table – Multicast MAC addresses	Switch# show mac-address-table multicast Vlan Mac Address COS Status Ports ----- 1 0100.5e40.0800 0 fa6-7 1 0100.5e7f.ffa 0 fa4,fa6-7
Show MAC Address Table – Static MAC addresses	Switch# show mac-address-table static Destination Address Address Type Vlan Destination Port ----- 0012.7710.0101 Static 1 fa7 0012.7710.0102 Static 1 fa7
Show Aging timeout time	Switch# show mac-address-table aging-time the mac-address-table aging-time is 300 sec.
Port Statistics	

Port Statistics	<pre>Switch# show rmon statistics fa4 (select interface) Interface fastethernet4 is enable connected, which has Inbound: Good Octets: 178792, Bad Octets: 0 Unicast: 598, Broadcast: 1764, Multicast: 160 Pause: 0, Undersize: 0, Fragments: 0 Oversize: 0, Jabbers: 0, Disacrd: 0 Filtered: 0, RxError: 0, FCSError: 0 Outbound: Good Octets: 330500 Unicast: 602, Broadcast: 1, Multicast: 2261 Pause: 0, Deferred: 0, Collisions: 0 SingleCollision: 0, MultipleCollision: 0 ExcessiveCollision: 0, LateCollision: 0 Filtered: 0, FCSError: 0 Number of frames received and transmitted with a length of: 64: 2388, 65to127: 142, 128to255: 11 256to511: 64, 512to1023: 10, 1024toMaxSize: 42</pre>
Port Mirroring	
Enable Port Mirror	<pre>Switch(config)# mirror en Mirror set enable ok.</pre>
Disable Port Mirror	<pre>Switch(config)# mirror disable Mirror set disable ok.</pre>
Select Source Port	<pre>Switch(config)# mirror source fa1-2 both Received and transmitted traffic rx Received traffic tx Transmitted traffic Switch(config)# mirror source fa1-2 both Mirror source fa1-2 both set ok.</pre> <p>Note: Select source port list and TX/RX/Both mode.</p>
Select Destination Port	<pre>Switch(config)# mirror destination fa6 both Mirror destination fa6 both set ok</pre>
Display	<pre>Switch# show mirror Mirror Status : Enabled Ingress Monitor Destination Port : fa6 Egress Monitor Destination Port : fa6 Ingress Source Ports :fa1,fa2, Egress Source Ports :fa1,fa2,</pre>
Event Log	
Display	<pre>Switch# show event-log <1>Jan 1 02:50:47 snmpd[101]: Event: Link 4 Down. <2>Jan 1 02:50:50 snmpd[101]: Event: Link 5 Up. <3>Jan 1 02:50:51 snmpd[101]: Event: Link 5 Down. <4>Jan 1 02:50:53 snmpd[101]: Event: Link 4 Up.</pre>
Ping	
Ping IP	<pre>Switch# ping 192.168.10.33 PING 192.168.10.33 (192.168.10.33): 56 data bytes 64 bytes from 192.168.10.33: icmp_seq=0 ttl=128 time=0.0 ms 64 bytes from 192.168.10.33: icmp_seq=1 ttl=128 time=0.0 ms 64 bytes from 192.168.10.33: icmp_seq=2 ttl=128 time=0.0 ms 64 bytes from 192.168.10.33: icmp_seq=3 ttl=128 time=0.0 ms 64 bytes from 192.168.10.33: icmp_seq=4 ttl=128 time=0.0 ms --- 192.168.10.33 ping statistics --- 5 packets transmitted, 5 packets received, 0% packet loss round-trip min/avg/max = 0.0/0.0/0.0 ms</pre>

4.12 Device Front Panel

Device Front Panel command allows you to see LED status of the switch. You can see LED and link status of the Power, DO, DI, R.M. and Ports.

Feature	On / Link UP	Off / Link Down	Other
Power	Green	Black	
Digital Output	Green	Black	
Digital Input	Green	Black	
R.M.(Ring Master)	Green	Black </td <td></td>	
Fast Ethernet	Green	Black	
Gigabit Ethernet	Green	Black	
SFP	Green	Black	Gray: Plugged but not link up yet.

- JetNet5010G
 - System
 - Basic Setting
 - Port Configuration
 - Network Redundancy
 - VLAN
 - Traffic Prioritization
 - Multicast Filtering
 - SNMP
 - Security
 - Warning
 - Monitor and Diag
 - Device Front Panel**
 - Save
 - Logout

Device Front Panel

The diagram shows the front panel of a JetNet 5010G switch. On the left, there are three SFP ports labeled 8, 9, and 10. Below them are RJ45 ports labeled 1 through 7. On the right side, there are two Power LEDs (labeled 1 and 2), a DO LED, a DI LED, and an R.M. LED. A Reset button is located to the right of the R.M. LED. The 'korenix JETNET' logo and model number '9600 N 81' are printed on the panel. The 'Device Front Panel' menu item from the navigation tree on the left is highlighted with a red box in the diagram.

Note: No CLI command for this feature.

4.13 Save to Flash

Save Configuration allows you to save any configuration you just made to the Flash. Powering off the switch without clicking on **Save Configuration** will cause loss of new settings. After selecting **Save Configuration**, click on **Save to Flash** to save your new configuration.

The screenshot shows the Korenix JetNet web interface. On the left is a navigation tree for 'JetNet5010G' with options like System, Basic Setting, Port Configuration, Network Redundancy, VLAN, Traffic Prioritization, Multicast Filtering, SNMP, Security, Warning, Monitor and Diag, Device Front Panel, Save, and Logout. The 'Save' option is highlighted. On the right, a 'Save to Flash' dialog box is displayed with the text: 'Note: This command will permanently save the current configuration to flash.' and a 'Save to Flash' button.

Command Lines:

Feature	Command Line
Save	<pre>SWITCH# write Building Configuration... [OK]</pre> <pre>Switch# copy running-config startup-config Building Configuration... [OK]</pre>

4.14 Logout

The switch provides 2 logout methods. The web connection will be logged out if you don't input any command after 30 seconds. The Logout command allows you to manually logout the web connection. Click on **Yes** to logout, **No** to go back the configuration page.



Command Lines:

Feature	Command Line
Logout	SWITCH> exit
	SWITCH# exit

5 Appendix

5.1 Product Specification.

Technology

Standard	IEEE 802.3 10Base-T Ethernet IEEE 802.3u 100Base-TX Fast Ethernet IEEE 802.3ab 1000Base-TX IEEE 802.3z Gigabit Ethernet Fiber IEEE 802.3x Flow Control and Back-pressure IEEE 802.1p class of service IEEE 802.1Q VLAN IEEE 802.1D-2004 Rapid Spanning Tree Protocol (RSTP) IEEE802.3ad LACP IEEE802.1X Port_based Network Access Control
-----------------	--

Performance

Switch Technology	Store and Forward Technology with 32Gbps Switch Fabric.
System Throughput	14,880pps for 10M Ethernet, 148,800pps for 100M Fast Ethernet, 1,488,100 for Gigabit Ethernet
Transfer packet size	64 bytes to 1522 bytes (with VLAN Tag)
MAC Address	8K MAC
Packet Buffer	1Mbits

Management

Configuration	Cisco-Like CLI, JetView, Web, HTTPS, SSH; TFTP/Web Update for firmware and configuration backup/restore, DHCP Client, Warm reboot, Reset to default, Admin password, Port Speed/Duplex control, status, statistic, MAC address table display, Static MAC, Aging time, SNMP v1, v2c, v3, Traps and RMON1.
SNMP	SNMP v1, v2c, v3 and OPC Server compatible
SNMP MIB	MIB-II, Bridge MIB, VLAN MIB, SNMP MIB, RMON and Private MIB
SNMP Trap	4 trap stations, Generic and Specific Traps.
Port Trunk	IEEE 802.3ad Trunk with LACP and Static Trunk. 5 trunk groups in maximum.
VLAN	802.1Q VLAN, GVRP. 64 VLAN groups, VLAN ID from 1 to 4094.
Quality of Service	Four priority queues per port, 802.1p COS and Layer 3 ToS/DiffServ

IGMP Snooping	IGMP Snooping v1/v2/v3 for multicast filtering and IGMP v1/v2 Query mode.
Rate Control	Ingress/Egress filtering for Broadcast, Multicast, Unknown DA or All packets.
NTP	Network Time Protocol to synchronize time from internet
Embedded Watchdog	Embedded hardware watchdog timer to auto reset when failure 6 seconds
Port Mirroring	Online traffic monitoring on multiple selected ports
E-mail Warning	SMTP, Automatic e-mail warning by pre-defined events
System Log	Supports both Local mode and Server mode.
802.1x	Port_based Network Access Control
DHCP Server	Can assign 255 IP address, support IP and MAC binding
Port Security	Assign authorized MAC to specific port
IP Security	IP address security to prevent unauthorized access
System Log	Supports both Local mode and Server mode.
Network Redundancy	
Multiple Super Ring	3rd generation Korenix Ring Redundancy Technology. The fastest failover time is 5ms and restore time is 0ms..
Legacy Super Ring	Client mode to backward compatible with Super Ring devices.
Any Ring	Inter-operate with other vendors' ring
Rapid Dual Homing	3 rd generation of Korenix Dual Homing Technology. Easily configuration and connect Korenix Rapid Super Ring with any other Switch or another Ring topology.
Rapid Spanning Tree	IEEE802.1D-2004 Rapid Spanning Tree Protocol. Compatible with Legacy Spanning Tree and IEEE802.1w.
Interface	
Number of Ports	10/100TX: 7 x RJ-45, Auto MDI/MDI-X, Auto Negotiation 10/100/1000TX: 3 x RJ-45, combo with SFP Gigabit Fiber / 100Base-FX: 3 x SFP with Hot- Swappable
Cables	10Base-T: 2-pair UTP/STP Cat. 3, 4, 5 cable, EIA/TIA-568 100-ohm (100m) 100 Base-TX: 2-pair UTP/STP Cat. 5 cable, EIA/TIA-568 100-ohm (100m) 1000 Base-TX: 2-pair UTP/STP Cat. 5 cable, EIA/TIA-568 100-ohm (100m)
LED Indicators	10/100 RJ-45: Link /Activity(Green), Full duplex/Collision (Yellow) Gigabit Copper: Link/Activity(Green) SPF: Link/Activity(Green)

	Unit: Power(Green), Digital Out(Red), Digital Input(Green), R.M.(Green)
RS232 Console:	RJ-45 Connector, Pin-3: TxD, Pin-6: RxD, Pin-5:GND
Power:	2 sets of power Input
Digital Input	2 sets of Digital Input. Logic Low (0): DC 0~10V Logic High(1): DC 11~30V
Alarm:	2 sets of Relay output for port break, power failure...
Reset:	Reset button is provided to restore default settings.
Power Requirements	
System Power	Dual Power Input, 12~48V/-12~-48V DC with Reverse Polarity Protection
Power Consumption	About 11.5 Watts @ DC 48V
Mechanical	
Installation	DIN-Rail mount or Wall Mount
Case	IP-31 protection, aluminum metal case
Dimension	137mm(H) x 96mm (W) x 119mm (D) (without DIN rail clip)
Weight	0.915 kg with package
Environmental	
Operating Temperature	-20℃ ~70℃
Operating Humidity	5% ~ 95%, non-condensing
Storage Temperature	-40℃ ~ 85 ℃
Hi-Pot	1.2 KV for all ports and power
Regulatory Approvals	
EMI	FCC Class A, EN55022 Class A.
EMC Immunity Interface	EN61000-4-2, EN61000-4-3, EN61000-4-4, EN61000-4-5, EN61000-4-6, EN61000-4-8, EN61000-4-11
Safety	CE/EN60950
Shock	IEC60068-2-27
Vibration	IEC60068-2-6
Free Fall	IEC60068-2-32
MTBF	249683 Hours ,*MIL-HDBK-217F GB(MILITARY HANDBOOK) standard
Warranty	Global 5 years

Note: Please refer to the latest datasheet. You can download from the web site.

Ordering Information

JetNet 5010G	Industrial 10-Port Managed Ethernet Switch Includes: <ul style="list-style-type: none"> ● 7-ports 10/100Base-TX and 3 10/100/1000 RJ-45/SFP Combo ports Switch
---------------------	--

- Quick Installation Guide, Documentation CD-ROM, Wall mounting plate and six screws

5.2 Pin Assignment of the RS-232 Console Cable

The total cable length is 150cm, excluding RJ-45 and DB-9!

DB-9 is 'Female.'

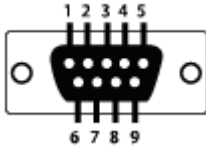

RJ-45 Pin	DB-9 Pin
1	7
2	9
3	4
4	5
5	1
6	3
7	2
8	8

5.3 Korenix SFP family

Korenix certificated many types of SFP transceiver. These certificated SFP transceivers can be identified by JetNet 5010G and displayed in the UI. The SFP transceivers we certificated can meet up the industrial critical environment needs. We recommend you to use Korenix certificated SFP transceivers when you constructing your network.

Korenix will keep on certificating and updating the certificated SFP transceivers in Korenix web site and purchase list. You can refer to the web site to get the latest information about SFP transceivers.

Note: Poor SFP transceivers may result in poor network performance or can't meet up claimed distance or temperature.

Model Name	Spec
SFPGSX	1000Base-SX multi-mode SFP transceiver,550m, -10~70°C
SFPGSX-w	1000Base-SX multi-mode SFP transceiver,550m, wide operating temperature, -40~85°C
SFPGSX2	1000Base-SX plus multi-mode SFP transceiver,2Km, -10~70°C
SFPGSX2-w	1000Base-SX plus multi-mode SFP transceiver, 2Km,wide operating temperature, -10~70°C
SFPG LX10	1000Base-LX single-mode SFP transceiver 10Km, -10~70°C
SFPG LX10-w	1000Base-LX single-mode SFP transceiver, 10Km, wide operating temperature, -40~85°C
SFPG LXH30	1000Base-LHX single-mode SFP transceiver,30Km, -10~70°C
SFPG LXH30-w	1000Base-LHX single-mode SFP transceiver, 30Km, wide operating temperature, -40~85°C
SFPGXD50	1000Base-XD single-mode SFP transceiver, 50Km, -10~70°C
SFPGXD50-w	1000Base-XD single-mode SFP transceiver, 50Km, wide operating temperature, -40~85°C
SFP100MM	Multi-mode 100Mbps 2KM Fiber Transceiver, 0~70°C.
SFP100MM-w	Multi-mode 100Mbps 2KM Fiber Transceiver, wide operating temperature -40~85°C.
SFP100SM30	Single mode 100Mbps 30KM Fiber Transceiver 0~70°C.
SFP100SM30-w	Single mode 100Mbps 30Km Fiber Transceiver, wide operating temperature. -40~85°C

5.5 Revision History

Edition	Date	Modifications
V0.1	Feb. 7, 2007	The first version
V0.2	Feb. 27, 2007	Revised version. Modify RSTP Bridge Priority description
V1.0	Mar. 1, 2007	Add Auto Ring Coupling figure and description. Modify VLAN description.
V1.1	Jul. 23, 2007	Add DHCP server setting Add IGMP Query setting Add SNMP v3 setting Correct the incorrect wording and update the latest Web UI figures
V2.0	Oct. 23, 2007	Modify System Time function Add GVRP function Add IGMP snooping V3 description Modify Rapid Super Ring function Add Force filtering function Add IEEE 802.1x function
V2.1	May 15, 2008	Modify Multiple Super Ring function Modify Rapid Dual Homing Modify IGMP function Add Time Synchronize Failure warning event Modify Private MIB ID
V2.2	20 Jun,2008	Modify the Pin Failure description of warning.

5.6 About Korenix

Less Time At Work! Fewer Budget on applications!

The Korenix business idea is to let you spend less time at work and fewer budget on your applications. Do you really want to go through all the troubles but still end up with low quality products and lousy services? Definitely not! This is why you need Korenix. Korenix offers complete product selection that fulfills all your needs for applications. We provide easier, faster, tailor-made services, and more reliable solutions. In Korenix, there is no need to compromise. Korenix takes care of everything for you!

Fusion of Outstandings

You can end your searching here. Korenix Technology is your one-stop supply center for industrial communications and networking products. Korenix Technology is established by a group of professionals with more than 10 year experience in the arenas of industrial control, data communications and industrial networking applications. Korenix Technology is well-positioned to fulfill your needs and demands by providing a great variety of tailor-made products and services. Korenix's industrial-grade products also come with quality services. No more searching, and no more worries. Korenix Technology stands by you all the way through.

Core Strength---Competitive Price and Quality

With our work experience and in-depth know-how of industrial communications and networking, Korenix Technology is able to combine Asia's research / development ability with competitive production cost and with quality service and support.

Global Sales Strategy

Korenix's global sales strategy focuses on establishing and developing trustworthy relationships with value added distributors and channel partners, and assisting OEM distributors to promote their own brands. Korenix supplies products to match local market requirements of design, quality, sales, marketing and customer services, allowing Korenix and distributors to create and enjoy profits together.

Quality Services

KoreCARE--- KoreCARE is Korenix Technology's global service center, where our professional staffs are ready to solve your problems at any time and in real-time. All of Korenix's products have passed ISO-9000/EMI/CE/FCC/UL certifications, fully satisfying your demands for product quality under critical industrial environments. Korenix global service center's e-mail is koreCARE@korenix.com

5 Years Warranty

Each of Korenix's product line is designed, produced, and tested with high industrial standard. Korenix warrants that the Product(s) shall be free from defects in materials and workmanship for a period of five (5) years from the date of delivery provided that the Product was properly installed and used. This warranty is voided if defects, malfunctions or failures of the warranted Product are caused by damage resulting from force measure (such as floods, fire, etc.), environmental and atmospheric disturbances, other external forces such as power line disturbances, host computer malfunction, plugging the board in under power, or incorrect cabling; or the warranted Product is misused, abused, or operated, altered and repaired in an unauthorized or improper way

Korenix Technologies Co., Ltd.
5F, No. 98-1, Ming-Chuan Rd., Shing Tien City, Taipei,
TaiwanTel:+886-2-82193000 Fax:+886-2-82193300

Business service : sales@korenix.com

Customer service: koreCARE@korenix.com