

User Guide
6651-2241

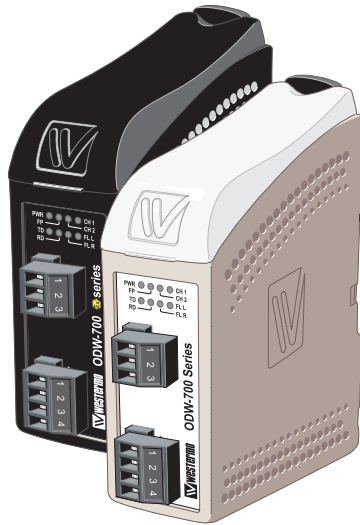

ODW-730-F1

Fibre Optic Modem



Industrial Converter
RS-485 to Fibre Optic Link.
Point to Point applications

www.westermo.com

Legal information

The contents of this document are provided "as is". Except as required by applicable law, no warranties of any kind, either express or implied, including, but not limited to, the implied warranties of merchantability and fitness for a particular purpose, are made in relation to the accuracy and reliability or contents of this document. Westermo reserves the right to revise this document or withdraw it at any time without prior notice.

Under no circumstances shall Westermo be responsible for any loss of data or income or any special, incidental, and consequential or indirect damages howsoever caused.

More information about Westermo can be found at the following Internet address:
<http://www.westermo.com>

Safety



Before installation:

Read this manual completely and gather all information on the unit. Make sure that you understand it fully. Check that your application does not exceed the safe operating specifications for this unit.

This unit should only be installed by qualified personnel.

This unit should be built-in to an apparatus cabinet, or similar, where access is restricted to service personnel only.

The power supply wiring must be sufficiently fused, and if necessary it must be possible to disconnect manually from the power supply. Ensure compliance to national installation regulations.

This unit uses convection cooling. To avoid obstructing the airflow around the unit, follow the spacing recommendations (see Cooling section).



Before mounting, using or removing this unit:

Prevent access to hazardous voltages by disconnecting the unit from the power supply.

Warning! Do not open a connected unit. Hazardous voltages may occur within this unit when connected to a power supply.



Class 1 Laser Product

This unit is designed to meet the Class 1 Laser regulations. However, the user is warned not to look directly into fibre optical port or any connected fibre.

Care recommendations

Follow the care recommendations below to maintain full operation of the unit and to fulfil the warranty obligations.

This unit must not be operated with covers or lids removed.

Do not attempt to disassemble the unit. There are no user serviceable parts inside.

Do not drop, knock or shake the unit. Rough handling beyond the specification may cause damage to internal circuit boards.

Do not use harsh chemicals, cleaning solvents or strong detergents to clean the unit.

Do not paint the unit. Paint can clog the unit and prevent proper operation.

Do not expose the unit to any kind of liquids (rain, beverages, etc).

The unit is not waterproof. Keep the unit within the specified humidity levels.

Do not use or store the unit in dusty, dirty areas. Connectors as well as other mechanical parts may be damaged.

If the unit is not working properly, contact the place of purchase, nearest Westermo distributor office, or Westermo Tech support.

Fibre connectors are supplied with plugs to avoid contamination inside the optical port.

The plug should be fitted when no optical fibre is inserted in the connector, e.g. during storage, service or transportation.

Note. Fibre Optic Handling

Fibre optic equipment requires careful handling as the fibre components are very sensitive to dust and dirt. If the fibre is disconnected from the modem, the protective plug on the transmitter/receiver must be replaced. The protective plug must be kept on during transportation. The fibre optic cable must also be protected in the same way. If this recommendation is not followed, it can jeopardise the warranty.

Cleaning of the optical connectors

In the event of contamination, the optical connectors should be cleaned by using forced nitrogen and some kind of cleaning stick.

Recommended cleaning fluids:

- Methyl-, ethyl-, isopropyl- or isobutyl-alcohol
- Hexane
- Naphtha

Maintenance

No maintenance is required, as long as the unit is used as intended within the specified conditions.

Agency approvals and standards compliance

Type	Approval / Compliance
EMC	EN 61000-6-1, Immunity residential environments
	EN 61000-6-2, Immunity industrial environments
	EN 61000-6-3, Emission residential environments
	EN 61000-6-4, Emission industrial environments
	EN 55022, Emission IT equipment, class A
	EN 55024, Immunity IT equipment
	FCC part 15 Class A
	EN 50121-4, Railway signalling and telecommunications apparatus
IEC 62236-4, Railway signalling and telecommunications apparatus	
Safety	EN 60950-1, IT equipment
ATEX*	EN 60079-0 and EN 60079-15

* Applicable for ODW-730-F1 Ex only

FCC Part 15.105 Notice:

This equipment has been tested and found to comply with the limits for a Class A digital device, pursuant to Part 15 of the FCC Rules. These limits are designed to provide reasonable protection against harmful interference when the equipment is operated in a commercial environment.

This equipment generates, uses, and can radiate radio frequency energy and, if not installed and used in accordance with the instruction manual, may cause harmful interference to radio communications. Operation of this equipment in a residential area is likely to cause harmful interference in which case the user will be required to correct the interference at his own expense.

EN 55022 Notice:

This is a class A product. In a domestic environment this product may cause radio interference in which case the user may be required to take adequate measures.



ATEX Information (Applicable for ODW-730-F1 EX only)

General

This unit is intended for use in Zone 2 hazardous location only.

Marking

 II 3 G

Ex nA IIC T4 Gc

SPECIAL CONDITION

WARNING – DO NOT SEPARATE WHEN ENERGIZED

	Indicate that this unit complies with relevant European standards that are harmonised with the 94/9/EC Directive (ATEX).
II	Equipment group II. This unit can be installed in all places with an explosive gas atmosphere other than mines susceptible to firedamp
3	Equipment category 3. A category is the classification according to the required level of protection. This unit ensures the requisite level of protection during normal operation and is intended for use in areas in which explosive atmosphere caused by gases, vapours, mists, or dust mixtures are unlikely to occur or, if they do occur, are likely to do so only infrequently and for a short period only.
G	Indicates protection concerning explosive atmospheres caused by gases, vapours or mists (G).
Ex	Indicates that this unit is in conformity with relevant European Ex standard(s).
nA	Type of protection used. This unit is a non-sparking device "nA" which is constructed to minimize the risk of occurrence of arcs or sparks capable of creating an ignition hazard during conditions of normal operation.
IIC	Gas group, a typical gas i hydrogen.
T4	Temperature class T4 (T4 = 135°C). This unit is classified in accordance with its maximum surface temperature (external and internal).
Gc	Equipment protection level Gc (EPL Gc). Equipment for explosive gas atmospheres, having a "enhanced" level of protection, which is not a source of ignition in normal operation and which may have some additional protection to ensure that it remains inactive as an ignition source in the case of regular expected occurrences. EPL Gc are analogous to the ATEX Categories (Category 3 G = EPL Gc).
SPECIAL CONDITION	This unit has a special condition of use. The special condition for safe use contains safety related information that is necessary for the correct installation and safe use.

Ratings

Power	(12 – 48) VDC; 300 mA
Ambient temperature	$-40^{\circ}\text{C} \leq T_a \leq +70^{\circ}\text{C}$
Ingress protection (IP)	IP21
Maximum surface temperatur	135°C (temperature class T4)

Safety Control Drawing

Degree of protection	IP 21
Ambient temperature	-40°C to $+70^{\circ}\text{C}$
Installation spacing	Minimum 25 mm above / below
	Minimum 10 mm left / right



Position	Description	Input / Output values
1	In & out / Relay contact (NO)	$U_{in} = 60\text{VDC max}$ $I_{in} = 500\text{ mA max}$
2	In & out / Relay contact (C)	
3	In & out / Relay contact (NC)	

Galvanically isolated via mechanical relay.
See user manual for proven transient protection.

Position	Description	Input / Output values
1	In+ (EIA RS-485 A)	$U_{max} = \pm 5\text{Vpk}$
2	In / R- (EIA RS-485 B)	$I_{max} = \pm 250\text{ mA}$
3	In/out / T+ (EIA RS-485 A)	Data rate:
4	In/out / T- (EIA RS-485 B)	300 bit/s to 1.5 Mbit/s

Position	Description	Output values
Rx	In / Receive port	Max 0 dBm
Tx	Out / Transmit port	

Position	Description	Input values	
1	In / Common	$U_{in} = (10 - 60)\text{VDC}$ $I_{in} = 400\text{ mA max}$ $P_{in} = \text{Max } 4\text{ W}$	
2	In / +Voltage A		
3	In / +Voltage B		
4	In / Common		

See section *Type tests and environmental conditions* in this user manual for proven transient protection.

SPECIAL CONDITION FOR SAFE USE

Ambient temperature:

This unit is designed for use in extreme ambient temperature conditions as follows:
 $-40\text{ }^{\circ}\text{C} \leq T_a \leq +70\text{ }^{\circ}\text{C}$

Installation in an apparatus cabinet:

This unit requires installation in an Ex certified apparatus cabinet suitable for the area of use and providing a degree of protection of at least IP54.

Resistance to impact:

This unit requires installation in an apparatus cabinet where adequate resistance to impact is provided by the apparatus cabinet. See "Installation in an apparatus cabinet" above for requirements on the external apparatus cabinet.

Resistance to light:

This unit requires installation in an apparatus cabinet where it is protected from light (for example daylight or light from luminaires).

See "Installation in an apparatus cabinet" above for requirements on the external apparatus cabinet.

Secureness of plugs:

When this unit is installed in an explosive atmospheres, all connectors must be mechanically secured to prevent loosening.

Conductor temperature:

When this unit is installed in locations with high ambient temperature, special precautions shall be taken upon the choice of external conductors and the temperature rating of the conductor(s).

Directive 94/9/EC alongside with other directives:

Directive 2004/108/EC (EMC) applies and to assure a safe performance of this unit under the scope of Directive 94/9/EC, refer to the electromagnetic immunity level specified under "Type tests and environmental conditions" in this manual.

Standards and date of compliance

EN 60079-0 and EN 60079-15
2010-12-17

Declaration of Conformity



Westermo Teleindustri AB

Declaration of conformity

The manufacturer Westermo Teleindustri AB
SE-640 40 Stora Sundby, Sweden

Herewith declares that the product(s)

Type of product	Model	Art no
Industrial fiberoptic repeaters/media converters	ODW-700 series	3651-07xx
	ODW-700EX series	3651-37xx

is in conformity with the following EC directive(s).

No	Short name
2004/108/EC	Electromagnetic Compatibility (EMC)
94/9/EC ¹	Equipment Explosive Atmospheres (ATEX)

References of standards applied for this EC declaration of conformity.

No	Title	Issue
EN 61000-6-1	Electromagnetic compatibility – Immunity residential environments	2007
EN 61000-6-2	Electromagnetic compatibility – Immunity industrial environments	2005
EN 61000-6-3	Electromagnetic compatibility – Emission residential environments	2007
EN 61000-6-4	Electromagnetic compatibility – Emission for industrial environments	2007
EN 55022	Information technology equipment - Emission	2006 + A1:2007
EN 55024	Information technology equipment - Immunity	1998 + A1:2001 + A2:2003
EN 50121-4	Railway applications – Electromagnetic compatibility – Emission and immunity of the signalling and telecommunications apparatus	2006
EN 60079-0	Explosive atmospheres – Equipment – General requirements	2009
EN 60079-15	Electrical apparatus for explosive gas atmospheres – Construction, test and marking of type of protection “n” electrical apparatus	2005

The last two digits of the year in which the CE marking was affixed: 11

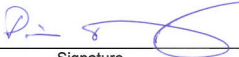

Signature

Pierre Öberg
Technical Manager
15th June 2011

¹ Applicable for ODW-700EX series only.

Postadress/Postal address	Tel.	Telefax	Postgiro	Bankgiro	Org.nr/ Corp. identity number	Registered office
S-640 40 Stora Sundby Sweden	016-428000 Int+46 16428000	016-428001 Int+46 16428001	52 72 79-4	5671-5550	556361-2604	Eskestuna

Type tests and environmental conditions

Electromagnetic Compatibility			
Phenomena	Test	Description	Level
ESD	EN 61000-4-2	Enclosure contact	± 6 kV
		Enclosure air	± 8 kV
RF field AM modulated	IEC 61000-4-3	Enclosure	10 V/m 80% AM (1 kHz), 80 – 800 MHz 20 V/m 80% AM (1 kHz), 800 – 1000 MHz 20 V/m 80% AM (1 kHz), 1400 – 2700 MHz
RF field 900 MHz	ENV 50204	Enclosure	20 V/m pulse modulated 200 Hz, 900 ± 5 MHz
Fast transient	EN 61000-4-4	Signal ports	± 2 kV
		Power ports	± 2 kV
Surge	EN 61000-4-5	Signal ports unbalanced	± 2 kV line to earth, ± 2 kV line to line
		Signal ports balanced	± 2 kV line to earth, ± 1 kV line to line
		Power ports	± 2 kV line to earth, ± 2 kV line to line
RF conducted	EN 61000-4-6	Signal ports	10 V 80% AM (1 kHz), 0.15 – 80 MHz
		Power ports	10 V 80% AM (1 kHz), 0.15 – 80 MHz
Pulse Magnetic field	EN 61000-4-9	Enclosure	300 A/m, 6.4 / 16 µs pulse
Voltage dips and interruption	EN 61000-4-11	AC power ports	10 & 5 000 ms, interruption 200 ms, 40% residual voltage 500 ms, 70% residual voltage
Mains freq. 50 Hz	EN 61000-4-16	Signal ports	100 V 50 Hz line to earth
Mains freq. 50 Hz	SS 436 15 03	Signal ports	250 V 50 Hz line to line
Radiated emission	EN 55022	Enclosure	Class B
	FCC part 15		Class A
Conducted emission	EN 55022	AC power ports	Class B
	FCC part 15	AC power ports	Class B
	EN 55022	DC power ports	Class A
Dielectric strength	EN 60950	Signal port to all other isolated ports	2 kVrms 50 Hz 1min
		Power port to other isolated ports	3 kVrms 50 Hz 1min 2 kVrms 50 Hz 1min (@ rated power < 60V)
Environmental			
Temperature		Operating	-40 to +70°C
		Storage & Transport	-40 to +70°C
		Maximum surface temperature	135°C (temperature class T4)
Humidity		Operating	5 to 95% relative humidity
		Storage & Transport	5 to 95% relative humidity
Altitude		Operating	2 000 m / 70 kPa
Service life		Operating	10 year
Vibration	IEC 60068-2-6	Operating	7.5 mm, 5 – 8 Hz 2 g, 8 – 500 Hz
Shock	IEC 60068-2-27	Operating	15 g, 11 ms
Packaging			
Enclosure, ODW-730 F1	UL 94	PC / ABS	Flammability class V-1
Enclosure, ODW-730 F1 EX		Cabelec 6141	
Dimension W x H x D			35 x 121 x 119 mm
Weight			0.26 kg
Degree of protection			IP 21
Cooling	IEC 529	Enclosure	Convection
Mounting			Horizontal on 35 mm DIN-rail

Functional description

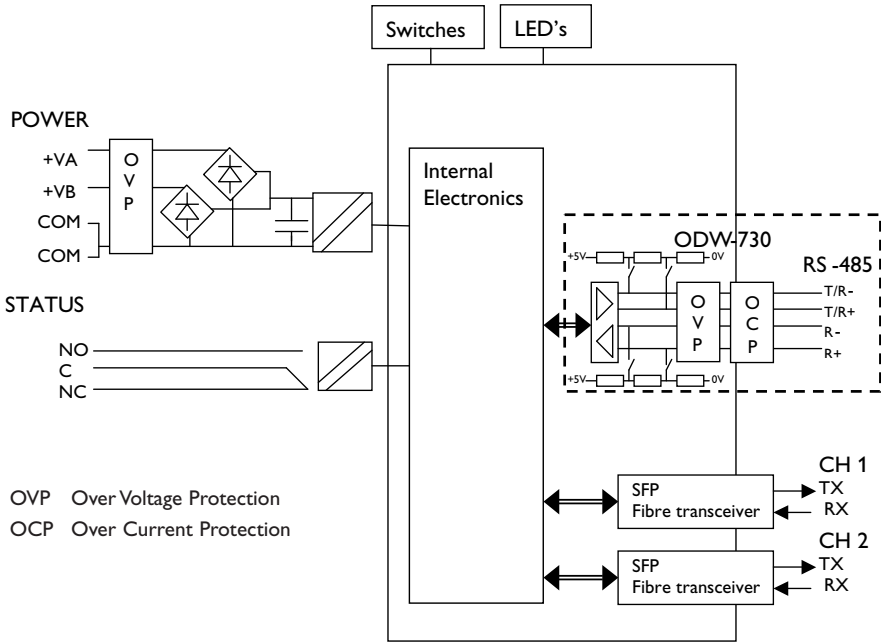

Converter serial interface – optical fibre

ODW-730 is a fibre optic modem that converts between electrical RS-485 and a fibre optical link.

ODW-730 can also be used to convert from RS-485 to RS-232 by using a ODW-730 in the same link as ODW-720.

Repeater – optical fibre links

ODW-730 is a fibre optic repeater that repeats received data from one fibre link out to the other link. This is useful e.g. for long distance communication, where electromagnetic interference may occur or when isolation of the electrical network is needed. The maximum optical fibre distance depends on selected fibre transceiver and fibre type. Distances up to 80 km (50 miles) are available.

Interface specifications

Power	
Rated voltage	ODW-730-F1: 12 to 48 VDC and 24 VAC ODW-730-F1 Ex: 12 to 48 VDC
Operating voltage	ODW-730-F1: 10 to 60 VDC and 20 to 30 VAC ODW-730-F1 Ex: 10 to 60 VDC
Rated current	400 mA @ 12 V 250 mA @ 24 V 100 mA @ 48 V
Rated frequency	ODW-730-F1 DC and 48 to 62 Hz ODW-730-F1 Ex: DC
Inrush current I ² t	0.2 A ² s
Startup current*	1.0 A _{peak}
Polarity	Reverse polarity protected
Redundant power input	Yes
Isolation to	RS-485 and Status port
Connection	Detachable screw terminal
Connector size	0.2 – 2.5 mm ² (AWG 24 – 12)
Shielded cable	Not required

* External supply current capability for proper startup

Status	
Port type	Signal relay, changeover contacts
Rated voltage	Up to 48 VDC
Operating voltage	Up to 60 VDC
Contact rating	500 mA @ 48 VDC
Contact resistance	< 50 mΩ
Isolation to	RS-485 and Power port
Connection	Detachable screw terminal
Connector size	0.2 – 2.5 mm ² (AWG 24 – 12)
Shielded cable	Not required

RS-422/485	
Electrical specification	EIA RS-485, 2-wire or 4-wire twisted pair
Data rate	300 bit/s – 1.5 Mbit/s
Data format	9 – 12 bits
Protocol	Start-bit followed by 8-11 bits
Retiming	Yes
Turning time (2-wire RS-485)	One t_{bit} $t_{bit} = 1 / \text{Baud rate}$ (Baud rate in bit/s)
Transmission range	< 1200 m, depending on data rate and cable type (EIA RS-485)
Settings	120 Ω termination and failsafe biasing 680 Ω
Protection	Installation Fault Tolerant (up to ± 60 V)
Isolation to	Status and Power port
Connection	Detachable screw terminal
Connector size	0.2 – 2.5 mm ² (AWG 24 – 12)
Shielded cable	Not required

Optical Power Budget

The allowed link length is calculated from the optical power budget (OPB), the available optical power for a fibre-optic link, and the attenuation of the fibre, comprising losses due to in-line connectors, splices, optical switches and a margin for link ageing (typical 1.5 dB for 1300 nm).

The worst-case optical power budget (OPB) in dB for a fibre-optic link is determined by the difference between the transmitter's output optical power (min) and the receiver input sensitivity (max).

FX (Fibre)	SM-LC80	SM-LC40	SM-LC15	MM-LC2
Fibre connector	LC duplex	LC duplex	LC duplex	LC duplex
Fibre type	Singlemode 9/125 μm	Singlemode 9/125 μm	Singlemode 9/125 μm	Multimode, 62.5/125 and 50/125 μm
Wavelength	1550 nm	1310 nm	1310 nm	1310 nm
Transmitter Output optical power min/max	-5/0 dBm**	-5/0 dBm**	-15/-8 dBm**	-20/-14 dBm*
Receiver Input sensitivity, max	-34 dBm	-34 dBm	-33 dBm	-31 dBm
Receiver Input optical power, max	0 dBm***	0 dBm***	0 dBm	-8 dBm
Optical power budget, worst-case	29 dB	29 dB	18 dB	11 dB
Transceiver type	Small Form Factor Pluggable (SFP) Multi-Sourcing Agreement (MSA) compliant			
Laser class	Class 1, IEC 825-1 Accessible Emission Limit (AEL)			

* Output power is power coupled into a 62.5/125 μm multimode fibre

** Output power is power coupled into a 9/125 μm singlemode fibre

*** The optical power should be reduced by at least 5 dB (SM-LC80 and Bi-di LC-60) or 3dB (SM-LC-40 and Bi-di LC-40) between the optical output and input.

FX (Fibre)	Bi-di LC-40	Bi-di LC-20	Bi-di MM LC-2
Fibre connector	LC Simplex	LC Simplex	LC Simplex
Fibre type	Singlemode 9/125 µm	Singlemode 9/125 µm	Multimode 62.5/125 and 50/125 µm
Wavelength nm, connector 1	Tx 1310, rx 1550	Tx1310, rx 1550	Tx 1310, rx 1550
Wavelength nm, connector 2	Tx 1550, rx 1310	TX 1550, rx 1310	Tx 1550, rx 1310
Transmitter Output optical power min/max	-8/0 dBm**	-14/8 dBm**	-10/-0 dBm*
Receiver Input sensitivity, max	-32 dBm	-31 dBm	-27 dBm
Receiver Input optical power, max	-3 dBm***	0 dBm	0 dBm
Optical power budget, worst-case	24 dB	17 dB	17 dB
Bit error rate (BER)	$< 1 \times 10^{-10}$	$< 1 \times 10^{-10}$	$< 1 \times 10^{-10}$
Transceiver type			
Laser class			

* Output power is power coupled into a 62.5/125 µm multimode fibre

** Output power is power coupled into a 9/125 µm singlemode fibre

*** The optical power should be reduced by at least 5 dB (SM-LC80 and Bi-di LC-60) or 3dB (SM-LC-40 and Bi-di LC-40) between the optical output and input.

Location of Interface ports, LED's and DIP-switches

ODW-730-F1

LED Indicators(for details see page 15)

DIP-switches accessible under lid
(for details see page 16–17)

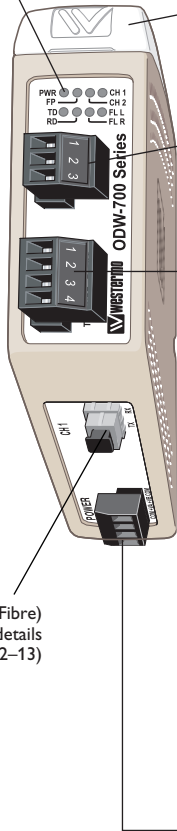

Status screw terminal

Position	Description	Product marking
1	Contact with C when fibre optical links are in operation	NO
2	Common	C
3	Open (no contact with C) when fibre optical links are not in operation	NC

RS-422/485 screw terminal

Position	Direction*	Description	Product marking
1	In	R+ (EIA RS-485 A')	R+
2	In	R- (EIA RS-485 B')	R-
3	In/Out	T+ (EIA RS-485 A)	T/R+
4	In/Out	T- (EIA RS-485 B)	T/R-

Power screw terminal

Position	Direction*	Description	Product marking
1	In	Common voltage	COM
2	In	Voltage A	+VA
3	In	Voltage B	+VB
4	In	Common voltage	COM

FX(Fibre)
(for details see page 12–13)

* Direction relative this unit

LED indicators

LED	Status	Description
PWR Power	ON	Power is on.
	OFF	Power is off.
FP		Not used
CH 2		Not used
CH 1 Channel 1 link status	ON	Fiber link to other unit has been established at CH 1.
	Flashing	Optical power detected but link to other unit has not been established at CH 1.
	OFF	No optical power detected and no link to other unit has been established at CH 1.
TD	Flash	Data received on the electrical interface and transmitted out on the optical interface.
	OFF	No data received on the electrical interface.
RD	Flash	Data received on the optical interface and transmitted out on the electrical interface.
	OFF	No data received on the optical interface.
FL R Failure link remote	ON	Remote fibre link failure. A fibre link is out of operation at any other unit than this one*.
	Flashing	Hardware error or invalid configuration.
FL L Failure link local	ON	Local fibre link failure. A fibre link is out of operation at this unit.
	Flashing	Hardware error or invalid configuration.

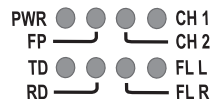

* Only valid if used together with ODW-720-F1 units in a multidrop network.

Note: During power up, all LED's will turn on for about 1 second.

DIP-switch settings







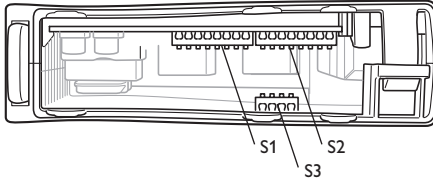













Before DIP-switch settings:

Prevent damage to internal electronics from electrostatic discharges (ESD) by discharging your body to a grounding point (e.g. use of wrist strap)

Note: Disconnect power before DIP-switch settings.



S1 DIP-switch, asynchronous mode speed selection

 300 bit/s	 57.6 kbit/s	 1.0 Mbit/s
 1200 bit/s	 115.2 kbit/s	 1.5 Mbit/s
 2400 bit/s	 125 kbit/s	 9 bits data format
 4800 bit/s	 187.5 kbit/s	 10 bits data format
 9600 bit/s	 230.4 kbit/s	 11 bits data format
 19.2 kbit/s	 250 kbit/s	 12 bits data format
 38.4 kbit/s	 500 kbit/s	 S:1:8 always OFF for point-to-point applications

Supervision table when selecting data format

Start bit	☐	☐	☐	☐	☐	☐	☐	☐
7 bit	☐	☐	☐	☐	☐	☐	☐	☐
8 bit	☐	☐	☐	☐	☐	☐	☐	☐
Parity	☐	☐	☐	☐	☐	☐	☐	☐
1 stop bit	☐	☐	☐	☐	☐	☐	☐	☐
2 stop bit	☐	☐	☐	☐	☐	☐	☐	☐
Number of bit	9	10	10	10	11	11	11	12

S1 DIP-switch, synchronous mode time frame selection

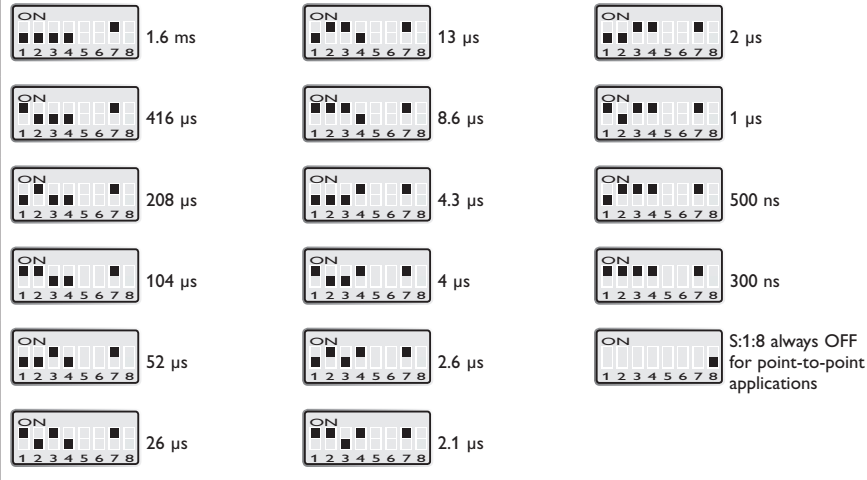

S2 DIP-switch



S3 DIP-switch



Factory default



Start up guide, point-to-point application

Follow the steps below to get the unit up and running in a simple application.

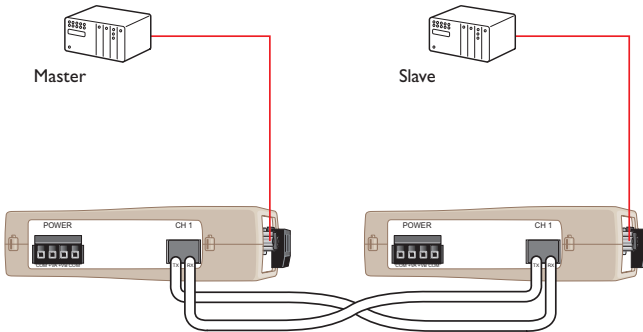

- ⌘ Make sure that DIP-switches S1:8 and S2:2 – S2:8 are set to factory default positions. (I.e. S1:8 OFF, S2:2 OFF, S2:3 ON and S2:4 – S2:8 OFF).
- ⌘ Configure both ODW-730-F1 units for the correct speed and data format using DIP-switches S1:1 – S1:7.
- ⌘ Select RS-485 2- or 4-wire mode using DIP-switch S2:1 (OFF = 2-wire, ON = 4-wire).
- ⌘ Enable the RS-485 termination / fail safe if required using DIP-switches S3:1 – S3:4 (S3:1 and S3:2 = 4-wire termination, S3:3 and S3:4 = 2-wire connection.)
- ⌘ Connect the fibre link between the ODW-730-F1.
- ⌘ Connect the power supply to both ODW-730-F1.
- ⌘ After a few seconds the fibre link should be in operation, indicated by an active CH1 LED.
- ⌘ Connect the serial cables from PLC master and slave to respective ODW-730-F1.
- ⌘ Frames from PLC master that are correctly received in the ODW-730-F1 will be indicated by flashing TD LED.
- ⌘ Frames that are received via the fibre link will be transmitted to the PLC slave and indicated by flashing RD LED.
- ⌘ Replies from slave to master will be transferred and indicated in the opposite way.
- ⌘ The point-to-point application is up and running.

RS-485 termination at system level

The system should be installed in according to the RS-485 specification. A system should always form a bus structure where the termination is at the end points of the bus. See diagrams for details of how this is done with RS-485 2-wire and 4-wire.

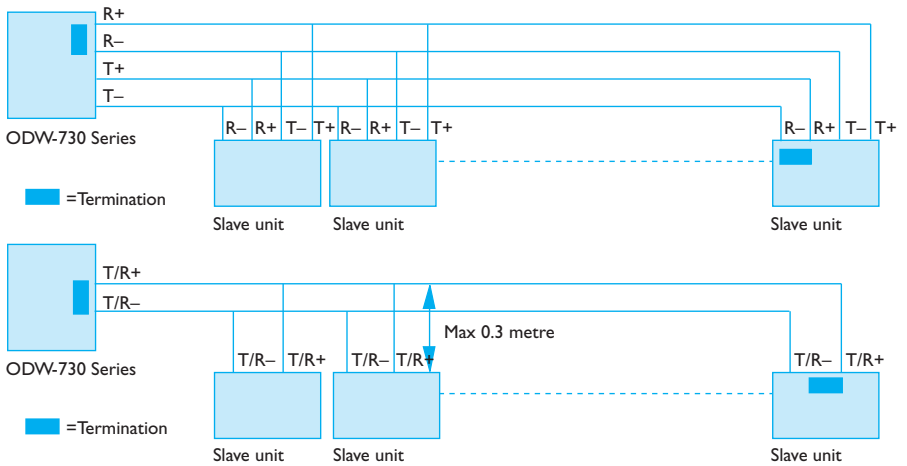

About the interfaces

Power terminal

The power terminal has two independent inputs, +VA and +VB, allowing redundancy should either fail. The ODW-730 power supply is galvanically isolated from all other internal electronics.

Optical fibre interfaces

ODW-730 uses Small Form Factor Pluggable (SFP) transceivers that are in compliance with the Multi-Sourcing Agreement (MSA). This means that a wide range of different fibre transceivers and connectors can be used.

RS-485 interface

A 4 position detachable screw terminal that can handle full duplex data rates up to 1.5 Mbit/s and can be set to either 2- or 4-wire RS-485 system.

When 4-wire RS-485 is selected, the terminals T/R+ and T/R- will always be set to transmit and terminals R+ and R- will always receive data.

Manchester coded protocol can be transferred with Synchronous mode.

Status port

The status port connects to an internal relay which may be used to trigger an external alarm if a fault condition occurs. During normal operation pins 1 and 2 are in contact with each other, and pins 2 and 3 are isolated. During an optical link failure, or power failure, pins 1 and 2 are isolated, and pins 2 and 3 are in contact with each other.

Mounting

This unit should be mounted on 35 mm DIN-rail, which is horizontally mounted inside an apparatus cabinet, or similar. Snap on mounting, see figure.

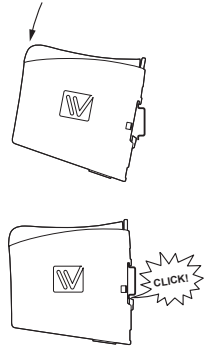

Cooling

This unit uses convection cooling. To avoid obstructing the air-flow around the unit, use the following spacing rules. Minimum spacing 25 mm (1.0 inch) above /below and 10 mm (0.4 inches) left /right the unit. Spacing is recommended for the use of unit in full operating temperature range and service life.

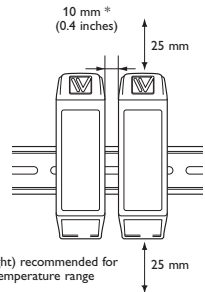

Removal

Press down the black support at the top of the unit. See figure.

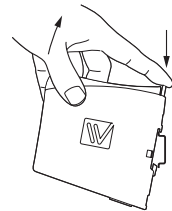



Westermo Teleindustri AB • SE-640 40 Stora Sundby, Sweden

Phone +46 16 42 80 00 Fax +46 16 42 80 01

E-mail: info@westermo.com

Westermo Web site: www.westermo.com

Sales Units

Sweden

Westermo Data Communications AB

Svalgängen 1

SE-724 81 Västerås

Phone: +46 (0)21 548 08 00 • Fax: +46 (0)21 35 18 50

E-Mail: info.sverige@westermo.se

United Kingdom

Westermo Data Communications Ltd

Talisman Business Centre • Duncan Road

Park Gate, Southampton • SO31 7GA

Phone: +44(0)1489 580-585 • Fax: +44(0)1489 580586

E-Mail: sales@westermo.co.uk

Germany

Westermo Data Communications GmbH

Goethestraße 67, 68753 Waghäusel

Tel.: +49(0)7254-95400-0 • Fax: +49(0)7254-95400-9

E-Mail: info@westermo.de

France

Westermo Data Communications S.A.R.L.

9 Chemin de Chilly 91160 CHAMPLAN

Tél : +33 1 69 10 21 00 • Fax : +33 1 69 10 21 01

E-mail : infos@westermo.fr

Singapore

Westermo Data Communications Pte Ltd

2 Soon Wing Road #08-05

Soon Wing Industrial Building

Singapore 347893

Phone +65 6743 9801 • Fax +65 6745 0670

E-Mail: sales@westermo.com.sg

North America

Westermo Data Communications

939 N. Plum Grove Road, Suite F

Schaumburg

Chicago

Phone: +1 847 619 6068

Fax: +1 847 619 66 74

E-mail: info@westermo.com

Taiwan

Westermo Data Communications Co

F2, No. 188, Pao-Chiao Rd.

Shing-Tien City

Taipei 23145

Phone: +886 2 8911 1710

E-mail: info@westermo.com

Westermo Teleindustri AB have distributors in several countries, contact us for further information.