

JetNet 4508f V2

Industrial 8-port Managed Fast Ethernet Fiber Switch

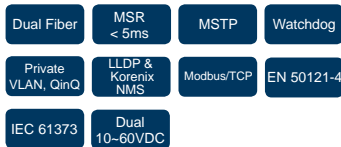

CE FC ~~X~~ RoHS



- 6-port 10/100TX and 2 100Base-FX fiber ports
- Supports Multi-mode 2KM, Single-mode 30KM
- 32Gbps Non-Blocking, 8K MAC address table
- Multiple Super Ring (recovery time <5ms), Rapid Dual Homing, Multiple Ring, and MSTP / RSTP
- VLAN, Private VLAN, QinQ, GVRP, QoS, IGMP Snooping V1/V2/V3, Rate Control, Port Trunking, LACP, Multi-Port Mirroring
- IEEE 802.1AB LLDP and Korenix NMS for auto-topology and group management
- Supports Modbus TCP/IP for Factory Automation
- Supports SNMP, Web, Telnet In-Band, Serial Out-Band Management
- Embedded Hardware Watchdog for System Auto Rescue
- Dual DC10~60V Power Input with Redundancy
- Advanced configurable Multiple-Event Alarm Output
- EN 50121-4 EMC and IEC 61373 vibration certifications for railway installations
- IP31 rugged aluminum case
- Operating temperature: -10~70°C (JetNet 4508f V2) and -40~75°C (JetNet 4508f-w V2)

- Industrial Intelligent NMS
- Rackmount PoE Plus Switch
- Industrial PoE Plus Switch
- Industrial 12-24V PoE Switch
- Industrial PoE Switch
- Rackmount L3/L2 Switch
- Gigabit Managed Ethernet Switch
- Managed Ethernet Switch
- Entry-level Switch
- Wireless Outdoor AP
- Embedded PoE/Router Computer (LINUX)
- Industrial Communication Computer (WIN/LINUX)
- Ethernet/PoE/Serial Board
- Ethernet I/O Server
- Media Converter
- Serial Device Server
- SFP Module
- Din Rail Power Supply

Overview

The JetNet 4508f V2 is a new 8-port industrial managed Fast Ethernet Switch with advanced network performance and high system reliability, including MSR and MSTP network redundancy technologies, for ensuring real-time and high quality connectivity in various networking applications. The Ethernet switch includes 6 10/100Mbps Fast Ethernet ports with RJ-45 connectors, two 100Mbps fiber ports and 32Gbps switch fabric to provide a real time non-blocking transmission performance for satisfying the needs of long distance and high bandwidth requiring application while ensuring traffic switching without data loss.

Besides, the new system design includes a hardware based watchdog timer for keeping the operating system live. It also provides power redundancy with wide range DC10V~60V inputs for ensuring the power continuity in the system. Combining the outstanding L2 management features along with the LLDP and the Korenix NMS Intelligent NMS into the ruggedized design with IP31 enclosure and -10~70°C (JetNet 4508f V2) and -40~75°C (JetNet 4508f-w V2) wide operating temperature, JetNet 4508f V2 switches provide highly reliable and secure data transmission under severe industrial environments.

Fiber Optic for Long Distance Data Transmission

To offer enhanced reliability, stability and extended connectivity, JetNet 4508f V2 is designed with 2 fiber ports with superior characteristics, including anti-electromagnetic interference, anti-moisture and anti-vibration capabilities. To meet your needs for various distance transmission, the fiber ports support several

connection types - Multi-mode fiber with 2KM link distance or Single-mode fiber with 30KM link distance. Moreover, the fiber connector supports duplex SC /ST or simplex SC for special requests of the Wavelength Division Multiplexing (WDM) applications.

High Performance Micro processor with embedded Hardware Watchdog Time

The JetNet 4508f V2 designed with 32 bits ARM-9E running at 180 MHz and with up to 200MIPS performance, combines an embedded hardware based watchdog timer to avoid system crashed by environmental factors, such as intense electromagnetic interference, extreme temperature variations and/ or any wrong instruction looping. This outstanding design can ensure the system stability and reliability when it installed in hardened environment.



Advanced L2 Network Control Performance and Security features

The JetNet 4508f V2 provides various network control and security features to ensure the reliable and secure network connection. To optimize the industrial network environment, the switch supports Tag -based VLAN, IGMP Snooping, IEEE 802.1s Multiple Spanning Tree, IEEE 802.1w Rapid Spanning Tree, Quality of Service (QoS), Link Aggregation Control Protocol (LACP), Rate Control, Port mirror,

etc. allowing users to fully handle network traffic and ensure the real-time data stream delivery. To avoid hacker's attacks and ensure the secure data transmission, JetNet 4508f V2 series features DHCP client, DHCP server with IP and MAC binding, 802.1X Access Control, SSH for Telnet security, IP Access table, port security, Private -VLAN for independent network traffic handling as well as many other security features.

Modbus TCP/IP for Factory Automation Network Enhancement

The Modbus TCP/IP protocol is supported in JetNet 4508f V2 series for factory automation applications. It enables administrator to connect to data acquisition (SCADA) system and read the switch's operating information using its own Modbus TCP/IP master program for monitoring and maintaining switch's status. With the supported Modbus TCP/IP, the JetNet 4508f V2 series become an element of factory automation such as the Programmable Logic Controller (PLC), Distributed Control System (DCS), and allow users to monitor/maintain factory equipment on the HMI (Human Machine Interface) system, including production information and communication status. Therefore, user does not need to integrate multiple management platforms to

monitor factory equipment: with just a single JetNet 4508f V2 platform users can easily achieve enhanced monitoring and maintenance of the entire factory.

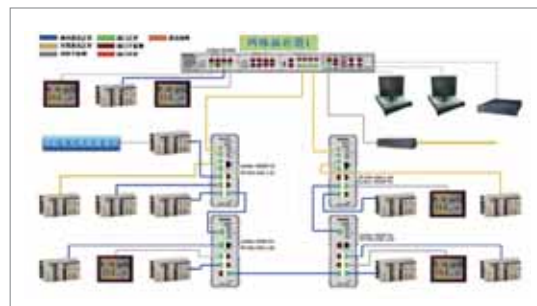

Easy-to-Configure Network Management Interface

For easy of configuration and monitoring, the JetNet 4508f V2 offers various of management interface , such as SNMP, Web Browser, In-Band Telnet and Out-Band Local serial console with command like interface.

The switch status as well as all the networking features can be enabled through these management interfaces. The failure notifications are later sent through e-mail, SNMP trap, Local/Remote system log, Fault event alarm relay.

In addition to all these management interfaces, JetNet 4508f V2 also supports Korenix View easy network management utility for achieving cost efficiency in system construction as well as the enhanced Korenix

NMS, which integrates comprehensive network monitoring features for auto topology discovery, device auto discovery, group IP address change and firmware upgrade.

Comprehensive Redundant Solutions – Multiple Super Ring (MSR™)

The JetNet 4508f V2 supports new generation ring technology - MSR™ (Multiple Super Ring), which includes various new technologies for different network redundancy applications and structures. It allows aggregating up to 4 Fast Ethernet Rings. With the MSR™ technology, a node can be configured to multiple rings with the failover time in as little as 5ms and zero-second of restoration time. In addition, users can extend the ring topology by adding hundreds of JetNet series to meet the large-scale network needs without compromising the network speed.

The MSR™ also allows the JetNet series to easily connect with core management switches via standard Rapid Spanning Tree Protocol or through multiple paths or nodes to increase the reliability by RDH™ (Rapid Dual Homing) technology. By integrating MSR™ and Link Aggregation Control Protocol (LACP) the JetNet series can enhance the link availability and increase the overall link capacity. Two or more Fast Ethernet connections are combined in order to increase the bandwidth and to create a resilient and redundant link.

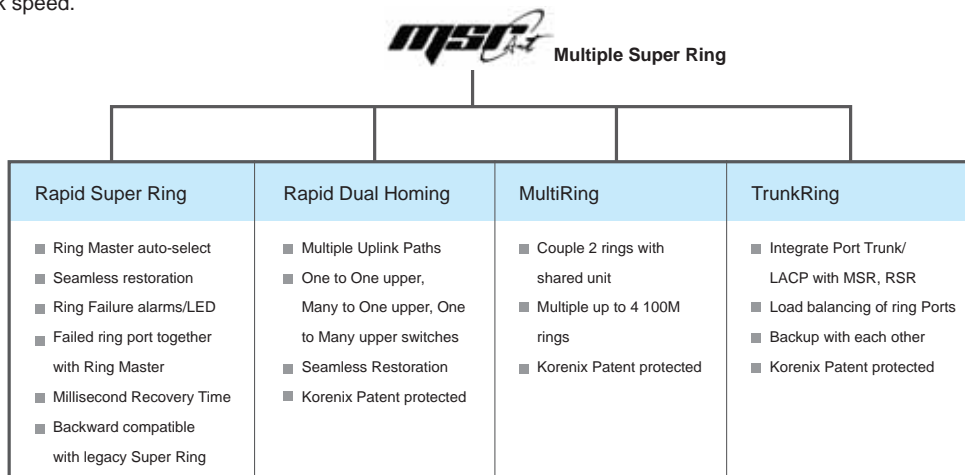

Rapid Super Ring (RSR™) Technology

Rapid Super Ring is the 2nd generation of Korenix Ring Redundancy technology. The recovery time is greatly improved from 20ms to few ms for both copper and fiber rings. The Ring master can be auto-selected by RSR engine. The 1st ring port of the R.M. is the primary path while the 2nd ring port of the R.M. is the block path. Once the primary path fails, the 2nd path will be recovered within few ms. Besides; the restoration time is also shortened to zero in the R.M. auto-selection mode.

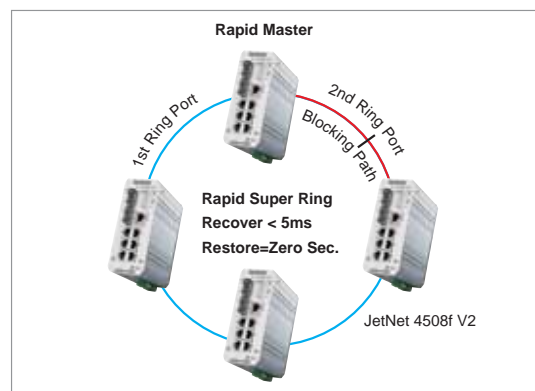

- Industrial Intelligent NMS
- Rackmount PoE Plus Switch
- Industrial PoE Plus Switch
- Industrial 12-24V PoE Switch
- Industrial PoE Switch
- Rackmount L3/L2 Switch
- Gigabit Managed Switch
- Managed Ethernet Switch
- Entry-level Switch
- Wireless Outdoor AP
- Embedded PoE/Router Computer (LINUX)
- Industrial Communication Computer (WIN/LINUX)
- Ethernet/PoE/Serial Board
- Ethernet I/O Server
- Media Converter
- Serial Device Server
- SFP Module
- Din Rail Power Supply

Seamless Ring Port Restoration™

Seamless restoration is a new Korenix patented technology which can restore a failed ring without causing any loop problem, topology change and packet

loss. With zero second restoration time, this mechanism eliminates any unstable status and guarantees the applications running non-stop.

Rapid Dual Homing (RDH™) Technology

Rapid Dual Homing is also an important feature of Korenix new generation Ring technology. It supports ring coupling with other vendors devices. Moreover, providing easy configuration and multiple redundancies, the failover time is much faster and the restoration time is zero ms. Uplinks can be auto detected and gathered into groups. In each group uplinks are sorted into primary,

secondary and standbys based on their link speed. The uplink with the highest speed is more likely to be active path for data transmission. Link aggregation is also integrated into RDH™. An uplink connection can be a single link or several links aggregated as a trunk, which provides better redundancy and link capacity.

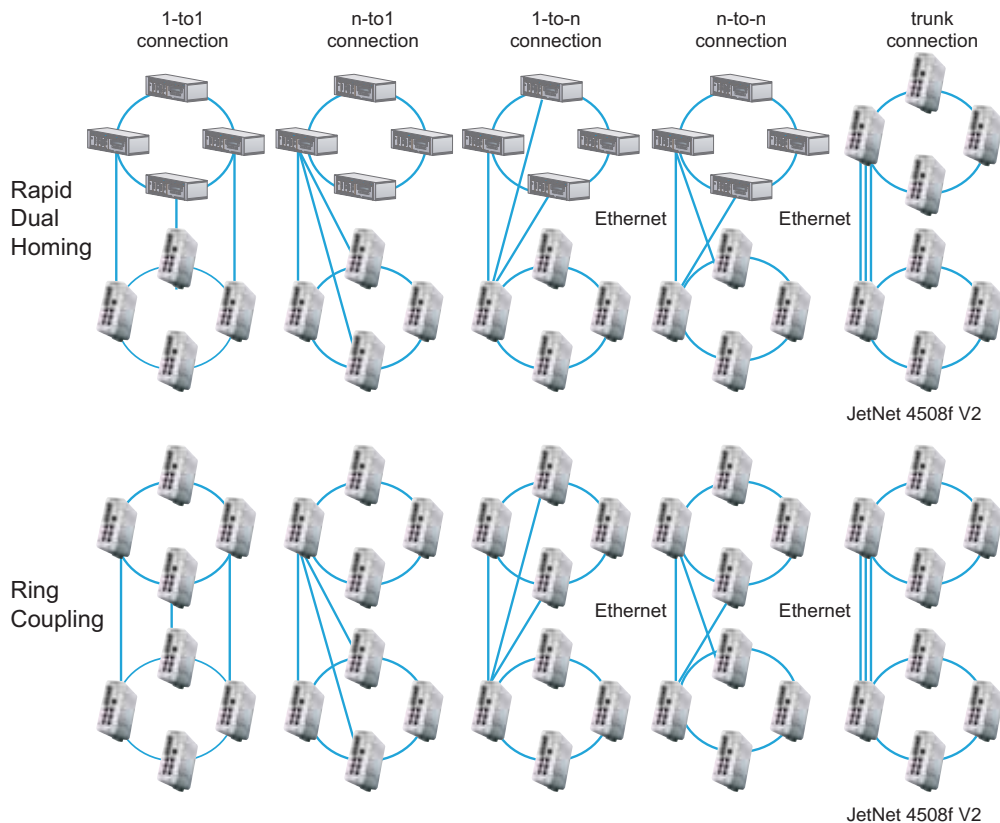

TrunkRing™

TrunkRing is a new feature in MSR which merges the two technologies of RSR and link aggregation. It takes advantages of aggregation to enhance the link redundancy, while increasing the link speed. The ring will open only if all the aggregated links are broken. Link aggregation can be achieved by either static trunk or LACP. Not all the link sections in a TrunkRing need to be the same. Ring links can be either symmetric or asymmetric. Some are a single path, and the others are aggregated by links where the number of links in a trunk group can be different. Users can enhance the link redundancy at different locations in accordance to the need. The link with less speed is more likely to be used as the backup path for restoring the network to full play capacity.

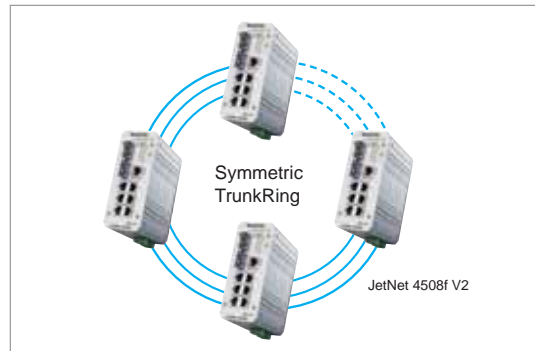
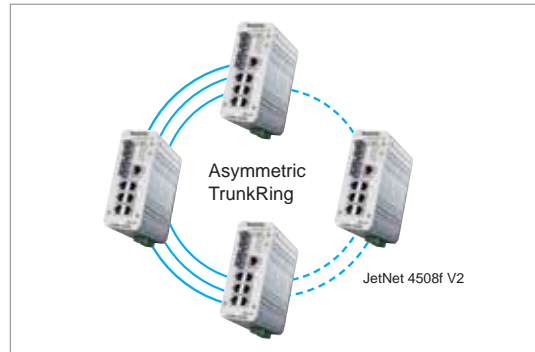

- Industrial Intelligent NMS
- Rackmount PoE Plus Switch
- Industrial PoE Plus Switch
- Industrial 12-24V PoE Switch
- Industrial PoE Switch
- Rackmount L3/L2 Switch
- Gigabit Managed Switch
- Managed Ethernet Switch
- Entry-level Switch
- Wireless Outdoor AP
- Embedded PoE/Router Computer (LINUX)
- Industrial Communication Computer (WIN/LINUX)
- Ethernet/PoE/Serial Board
- Ethernet I/O Server
- Media Converter
- Serial Device Server
- SFP Module
- Din Rail Power Supply

MultiRing™

The MultiRing™ provides easier connectivity between two ring networks. The simplest example is to connect two rings by a single device. Depending on the number of ports and the speed, the JetNet 4508f V2 can connect as a 100Mbps ring and uplink with JetNet 5010G or higher level Korenix Industrial Switch. As shown in the below figure, MultiRing™ technology simply extends the network topology by linking multiple

rings into a line or into multiple directions. In addition to extensibility, MultiRing™ has great diversity of various ring technologies. When MultiRing™ enabled, JetNet 4508f V2 can connect RSR rings, TrunkRing™ and a Super Ring together and simultaneously provide more Fast Ethernet Ring connectivities. This provides extensibility to new technologies while keeping the great backward compatibility.

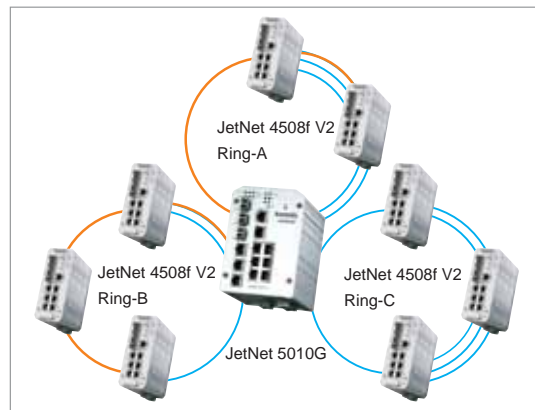
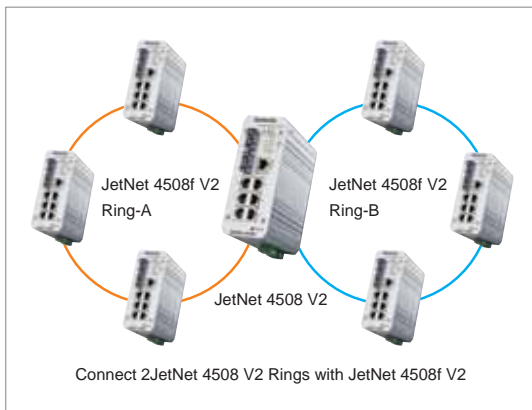

Link Aggregation Control Protocol

Link Aggregation Control Protocol allows users grouping multiple Ethernet ports in parallel to increase the link bandwidth. The aggregated ports can be viewed as one physical port, so that the bandwidth is higher than just one single Ethernet port. The member ports of the same trunk group can balance the loading and backup with each other. The LACP feature is usually used when higher bandwidth is needed for the backbone network. This is a cost-effective way for transferring much more data. If the trunk port is also assigned as a ring port, it will become a TrunkRing, which means the bandwidth of ring path has increased with port trunk technology. Now, there is no recovery time when failure occurred. The JetNet 4508f V2 provides a simple and easy way to aggregate port bandwidth into Rapid Super Ring.

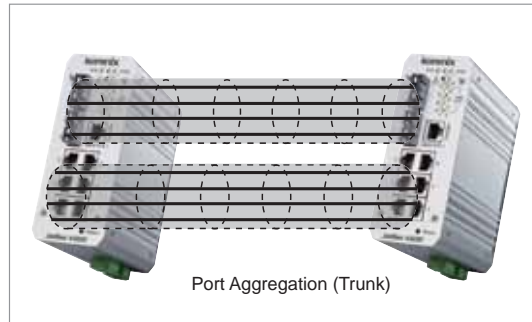

IEEE 1588 Precision Time Protocol (PTP)

The Precision Time Protocol is designed to synchronize time across Ethernet networks. It allows synchronization of distributed clocks to sub-microsecond accuracy for devices that may have differing precision, resolution and stability. JetNet 4508f V2 supports Auto (or bindery clock), Master and Slave modes for time synchronization to achieve

a high level of synchronization within an industrial motion-control environment with a minimum use of network and computing resources. The protocol helps for sequencing event measurements, scheduling outputs, synchronizing actuation, time-stamping, coordinating event records, etc.

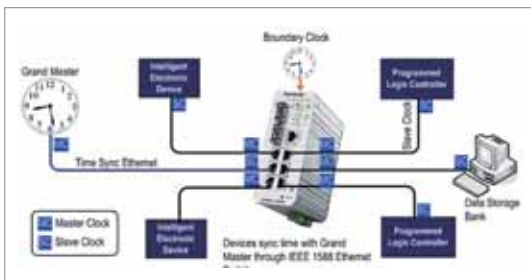

IEEE 1588	
PTP State	Enable
Mode	Auto
	Auto
	Master
	Slave

Auto Topology Discovery & Efficient Management through LLDP and Korenix NMS

JetNet 4508f V2 supports topology discovery or LLDP (IEEE 802.1AB Link Layer Discovery Protocol) function that can help users to discover multi-vendor's network devices on the same segment by an NMS system, which support LLDP function. With LLDP function, NMS can easily maintain the topology map, display port ID, port description, system description, VLAN ID, etc.. Once a link failure happens, the topology changed events are updated to the NMS to help users easily maintain the network system. Besides the SNMP and LLDP protocols, JetNet 4508f V2 series efficiently works with the Korenix patented Korenix NMS, which in addition to the auto-topology discovery, also delivers MSR™ group management, group IP assignment, firmware upgrade, configuration file backup/ restore ,SNMP MIB Browser /compile, etc. Furthermore, users can export the topology map to diverse formats,

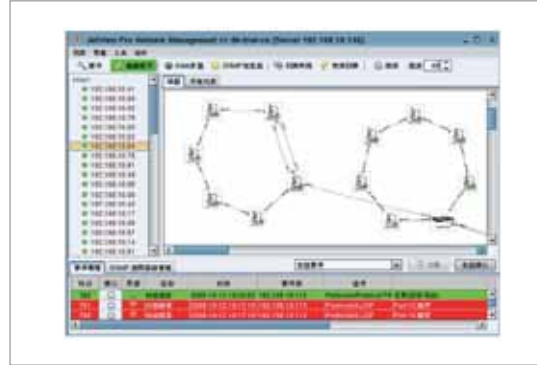

such as JPG, BMP, PNG and PDF, for easily managing and trouble-shooting the network. The user-friendly software allows administrators to discover devices automatically and efficiently manage the performance of the industrial network.

Rugged Design for Harsh Environments

The JetNetf 4508f V2, compliant with the electromagnetic conformance requirements of industry application, provides a high level electromagnetic susceptibility exceeding the requirements of railway EMC standard - EN 50121-4, IEC 61373 as well as Traffic control and Heavy industrial standards with distinguished electrical slow transient (Surge), Radio-Frequency Electromagnetic Field (RS),

Electrical Fast Transient (EFT) protection.

Equipped with a rugged aluminum case with high thermal-conductivity design, it is capable of resisting -10~70°C (JetNet 4508f V2) and -40~75°C (JetNet 4508f-w V2) wide temperature ranges while providing reliable connectivity under harsh industrial environments.

JetNet 4508f V2 Appearance

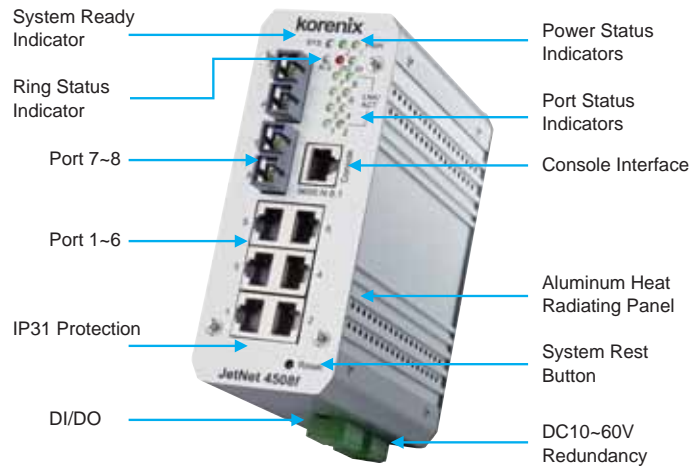

- Industrial Intelligent NMS
- Rackmount PoE Plus Switch
- Industrial PoE Plus Switch
- Industrial 12-24V PoE Switch
- Industrial PoE Switch
- Rackmount L3/L2 Switch
- Gigabit Managed Switch
- Managed Ethernet Switch
- Entry-level Switch
- Wireless Outdoor AP
- Embedded PoE/Router Computer (LINUX)
- Industrial Communication Computer (WIN/LINUX)
- Ethernet/PoE/ Serial Board
- Ethernet I/O Server
- Media Converter
- Serial Device Server
- SFP Module
- Din Rail Power Supply

Dimension (Unit = mm)

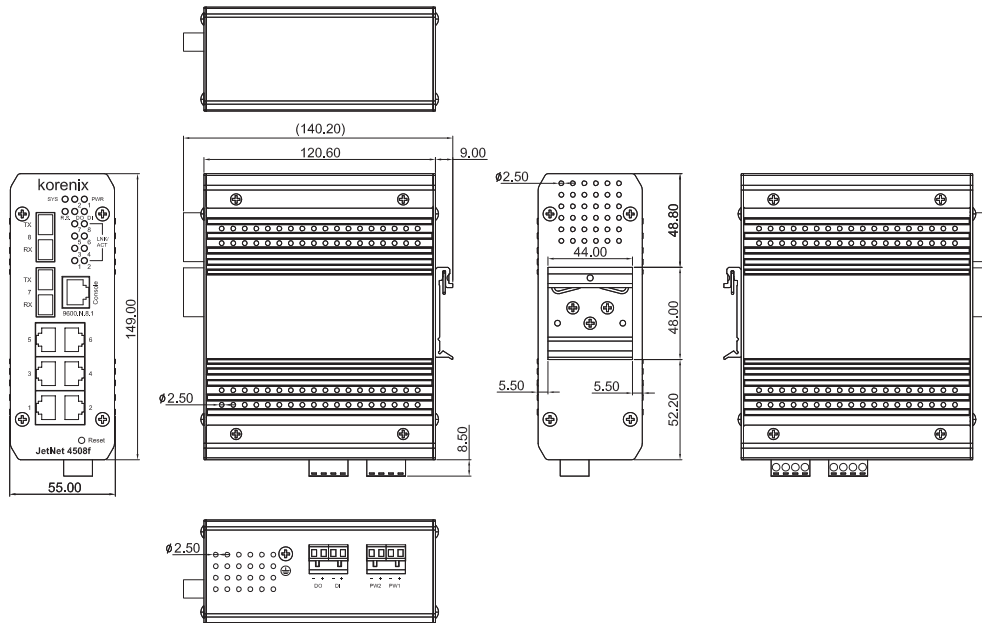

Specification

Technology

Standard:

- IEEE 802.3 10Base-T Ethernet
- IEEE 802.3u 100Base-TX Fast Ethernet
- IEEE 802.3x Flow Control and Back-pressure
- IEEE 802.1AB Link Layer Discovery Protocol (LLDP)
- IEEE 802.1p Class of Service (CoS)
- IEEE 802.1Q VLAN and GVRP
- IEEE 802.1QinQ
- IEEE 802.1D-2004 Rapid Spanning Tree Protocol (RSTP)
- IEEE 802.1s Multiple Spanning Tree Protocol (MSTP)
- IEEE 802.3ad Link Aggregation Protocol (LACP)
- IEEE 802.1x Port Based Network Access Protocol
- IEEE 1588 Precision Time Protocol (PTP)

Modbus TCP/IP

Performance

Switch Technology:

Store and Forward Technology with 32Gbps Switch Fabric.

System Throughput:

- 26 Mega packets per second, 64 bytes packet size
- 14,880 pps for 10Base-T
- 148,800 pps for 100Base-TX (PPS: Packet Per Second)

CPU performance: 32 bits ARM-9E running at 180 MHz and performance up to 200MIPS; Embedded hardware based watchdog timer.

System Memory: 8M bytes flash ROM, 64M bytes SDRAM.

Transfer packet size 64 bytes to 1522 bytes (includes 1522 bytes VLAN Tag).

MAC Address: 8K MAC address table.

Packet Buffer: 1M bits shared memory for packet buffer.

Transfer performance: 14,880 pps for Ethernet and 148,800 pps for Fast Ethernet

Relay Alarm: Dry Relay output with 1A /24V DC ability. It supports multiple event reply function to alert either one of event occurred – power, port link, DI/Ring status change, Ping Reset or perform routing relay on/off behavior.

Digital Input (DI):

One Digital Input with Photo Copular isolation

Digital Hi: DC 11V~30V

Digital Low: DC 10V~0V

System Management

Configuration and monitoring interface: Supports 4 configuration and monitoring interfaces: RS-232 serial console, Telnet, SNMP and Web Browser interface. The RS-232 and Telnet interfaces support Cisco like instructions.

System upgrade/Backup: Provides TFTP/Web interface for firmware upgrade and configuration backup, restore.

Telnet & Local Console: Supports command line interface with Cisco like commands and maximum 4 sessions; the telnet interface also supports SSH.

SNMP: Supports v1, v2c, V3 with SNMP trap function, trap station up to 4 and can be manually configured the trap server IP address.

SNMP MIB: MIBII, Bridge MIB, Ethernet-like MIB, VLAN MIB, IGMP MIB, Korenix Private MIB.

Korenix Utility: Supports Korenix View and Korenix NMS with IEEE 802.1AB Link Layer Discovery Protocol for device finding and link topology discovery

Network Time Protocol: Supports NTP protocol with daylight saving function and localize time sync function.

Management IP Security: IP address security to prevent unauthorized access

E-mail Warning: 4 receipt E-mail accounts with mail server authentication

System Log: Supports both Local or remote Server with authentication

Network Performance

IEEE 802.3x: Flow control pause frame supports on 10/100bps with Full Duplex and Back-pressure supports on 100 / 10Mbps Half Duplex only

Port Configuration: Port link Speed, Link mode, current status and enable/disable

Port Trunk: IEEE 802.3ad port aggregation and static port trunk; trunk member up to 4 ports and maximum 4 trunk groups.

VLAN: IEEE 802.1Q Tag VLAN with 256 VLAN Entries and provides 2K GVRP entries

3 VLAN link modes- Trunk, Hybrid and Link access

Private VLAN: Direct client ports in isolated/community VLAN to promiscuous port in primary VLAN

QinQ: Double VLAN Tag in an Ethernet frame

Class of Service: IEEE 802.1p class of service; per port 4 priority queues.

QoS (Quality of Service): Supports 4 physical queues, weighted run robin queuing (WRR 8:4:2:1) and Strict Priority scheme, which follows 802.1p COS tag and IPv4 ToS/Diffserv information to prioritize the traffic of your industrial network.

IGMP Snooping: IGMP Snooping v1/v2 /v3 for multicast filtering and IGMP Query mode; also support unknown multicasting process forwarding policies- drop, flooding and forward to router port.

Rate Control: Ingress filtering for Broadcast (Broadcast Storm Control), Multicast, Unknown DA or all packets. Egress filtering for all packet types.

Port Mirroring: Online traffic monitoring on multiple selected ports

Port Security: Port security to assign authorized MAC to specific port

DHCP: DHCP Client, DHCP Server with IP & MAC Address binding and DHCP agent (option 82).

IEEE 802.1x: Port based network access control

Radius: Login by Radius account/password, Key for Radius Server Authentication

Modbus TCP/IP: Supports open protocol- Modbus TCP/IP with function code group -4 for factory automation application.

Network Redundancy

Multiple Super Ring (MSR)TM: New generation Korenix Ring Redundancy Technology, Includes Rapid Super Ring, Rapid Dual Homing, TrunkRingTM, MultiRingTM and backward compatible with legacy Super RingTM

Rapid Dual Homing (RDH)TM: Multiple uplink paths to one or multiple upper switch

TrunkRingTM: Integrate port aggregate function in ring path to get higher throughput ring architecture

MultiRingTM: Couple or multiple up to 16 Rapid Super Rings, JetNet 4508f V2 supports up to 4 Fast Ethernet Ring in one Switch

IEEE802.1d: IEEE802.1D-2004 Rapid Spanning Tree Protocol. Compatible with Legacy

Rapid Spanning Tree: Spanning Tree and IEEE 802.1w

IEEE802.1s^{Note-1}: Supports multiple RSTP deployed in a VLAN or multiple VLANs.

Multiple Spanning Tree: IEEE802.1s MSTP, each MSTP instance can include one or more VLANs

Interface

Enclosure Port:

Fast Ethernet communication port: RJ-45 connector

RS-232 console interface: RJ-45 connector

100Mbps Fiber interface: SC or ST (by request)

DI/DO port: 4-pin removable terminal block

Power port: 4-pin removable terminal block

Cables:

10Base-T: 2-pairs UTP/STP Cat. 3, 4, 5 cable,

EIA/TIA-568B 100-ohm (100m)

100 Base-TX: 2-pairs UTP/STP Cat. 5 cable,

EIA/TIA-568B 100-ohm (100m)

JetNet 4508f-m V2: multi-mode, 50~62.5/125um, 2KM

JetNet 4508f-s V2: single mode, 8~10/125um, 30KM

Fiber port characteristics:

JetNet 4508f-m V2

Wavelength:1310nm

Tx power: -20dBm ~ -14dBm

Rx sensitivity: -31dBm ~ 0dBm

Link Budget: 11dB

JetNet 4508f-s V2

Wavelength: 1310nm

Tx power: -15dBm ~ -8 dBm

Rx sensitivity: -34dBm ~ 0 dBm

Link Budget:19dB

RS-232 serial interface: Supports Cisco like command line interface for out-band management

System Diagnostic LEDs

System:

Power status (Green): On (power is on applying)

Digital Input (Green): On (Digital signal is detected)

Alarm Output (Red): On (Output conductor is formed as a close circuit)

System (Green): On (the system is ready), Blinking (system is on firmware upgrade progress)

Ring Status: Green on (Ring normal) / Blinking (Ring with wrong port), Yellow on (Ring abnormal) / Blinking (device's ring port failed)

Fast Ethernet port: Link (Green On) / Activity (Green Blinking)

Power Requirements

System Power:

Redundant power input with polarity auto reverse protection

Input Range: 10~60V DC

System Type: Positive or Negative power source

Power Consumption: 15Watts / DC 24V

Industrial
Intelligent
NMS

Rackmount
PoE Plus
Switch

Industrial
PoE Plus
Switch

Industrial
12-24V
PoE Switch

Industrial
PoE Switch

Rackmount
L3/L2 Switch

Gigabit
Managed
Switch

Managed
Ethernet
Switch

Entry-level
Switch

Wireless
Outdoor AP

Embedded
PoE/Router
Computer
(LINUX)

Industrial
Communication
Computer
(WIN/LINUX)

Ethernet/PoE/
Serial Board

Ethernet
I/O Server

Media
Converter

Serial Device
Server

SFP Module

Din Rail
Power Supply



Mechanical

Installation: DIN Rail Mounting or Wall Mounting

Case: Aluminum metal case with grade 31 protection

Dimension (mm):

55(W) x 149(H) x 131.2 (D) / with DIN Rail Clip

55(W) x 149(H) x 120.6(D) / without DIN Rail Clip

Weight: 0.885kg without package

Environmental

Operating Temperature:

-10 ~ 70°C (JetNet 4508f V2)

-40 ~ 75°C (JetNet 4508f-w V2)

Operating Humidity: 0% ~ 95%, (non-condensing)

Storage Temperature: -40 ~ 85°C

Hi-Pot: AC 1.5KV for all ports and power

Regulatory Approvals

EMI: FCC Class A, CE/ EN55022 Radiation, Conduction, Heavy Industrial IEC/EN 61000-6-2,

EMS: IEC 61000-4-2, IEC 61000-4-3, IEC 61000-4-4, IEC 61000-4-5, IEC 61000-4-6, IEC 61000-4-8, IEC 61000-4-9, Heavy Industrial IEC/EN 61000-6-4

Railway EMC: EN 50121-4 and EN 50121-1

Railway Vibration/Shock: IEC 61373

Free Fall: IEC60068-2-32 with package ^{Note-3}

MTBF: 661,248 Hours, MIL-HDBK-217F GB standard

Warranty: 5 years

Note-1: available in the further version software

Note-2: pending

Note-3: Korenix's internal testing

Ordering Information

JetNet 4508f V2 Industrial 8-port Managed Fast Ethernet Fiber Switch, -10~70°C

JetNet 4508f-w V2 Industrial 8-port Managed Fast Ethernet Fiber Switch, -40~75°C

Includes:

- JetNet 4508f V2 / 4508f-w V2
- Quick Installation Guide
- Documentation CD-ROM
- RS-232 console Cable